

The specialist for fastening technology

Eurotec[®]

Eurotec[®]

SPECIAL COMPONENTS

INDIVIDUAL SOLUTIONS FOR
YOUR BUILDING PROJECT

Complete catalogue

Order or download it as a PDF file
from www.eurotec.team/en

E.u.r.o.Tec GmbH

Unter dem Hofe 5 · D-58099 Hagen · Germany

Tel. +49 2331 62 45-0 · Fax +49 2331 62 45-200

email info@eurotec.team · www.eurotec.team/en

More than

20

YEARS
of quality

About Eurotec

We are a medium-sized company engaged in the development, production and sale of products for the construction sector.

To this end, we supply products for the areas of timberframe construction, deck construction and concrete fastening. We supply specialized dealers across Europe, who are responsible for distribution to skilled craftsmen.

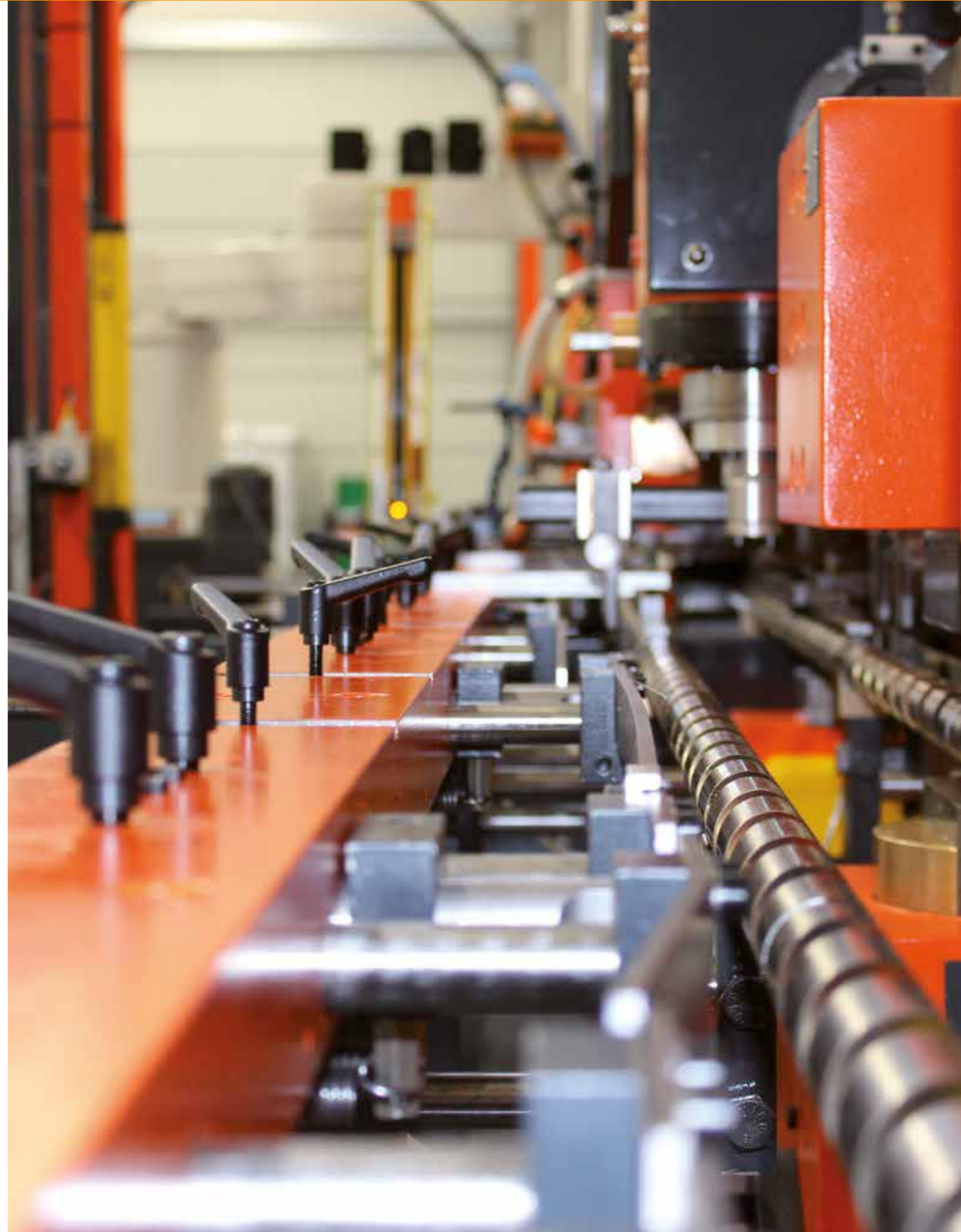

Our technology and engineering department

Many of the processes and operations that other companies out-source to service providers are carried out in-house.

By doing so, we ensure that our customers receive everything from a single source and that they have direct contacts within our company for their projects. Originating from diverse areas of construction, our specialists produce designs in 2D or 3D, order and inspect initial samples, submit applications for certifications, make patent applications, issue approvals, monitor batch production, and much more.

All items in the core product range are certified by an European Technical Approval and test reports that are vital for the construction sector, reflecting our high quality standards.

In addition to this, we also offer a broad portfolio of services. These vary from free calculations for your construction projects to a wide range of sales aids such as sets of sample shelves and sample decking, as well as various application videos. We even offer training for our customers' staff.

With our products, we either respond to the general requirements of the market or work with customers to develop solutions for specific areas.

Our customers receive a complete package with an emphasis on product quality.

▶ Individual solutions for complex structures

Since wood has become increasingly popular as a building material from an environmental protection standpoint – and cross laminated timber explicitly in building construction – we have increasingly found ourselves exploring the issue of fastening and anchoring prefabricated wood elements.

In this regard, we are focusing on both the efficiency and the quality of products from the complex field of timber engineering. At the very heart of this ambitious architecture lie complicated shapes, enormous structure spans and considerable static challenges.

We are capable of developing and manufacturing unique solutions – including halls for industry, trade and agriculture, as well as bridges or more complex roof structures – in these field of modular construction for our customers.



▶ Special elements

Customised solutions for many projects. From ground anchor plates with transverse bracing in heavy timber construction that are connected to one another with steel cables, to cross flat connectors for heavily loaded timber connections with individual hole patterns.

- Optimum load distribution thanks to individual adjustments to your projects
- Better utilisation of the individual connectors, for highly stressed junctions in timber engineering



Metal or aluminium wood connectors

Our straps complement the connections in modern timber construction. They support the framings' screw connections to enable better distribution of additional loads. They impress because they are quick and easy to assemble, and can also be put to universal use.



© Adobe Stock

Eurotec

Eurotec

Eurotec

Eurotec

Eurotec

Eurotec

Eurotec

Eurotec

Eurotec module connector

Our new products include tension brackets, shearing angles, shearing plates, tie bars and tension straps. They are used for anchoring walls, columns and ceilings.

The special features of the shearing angles and tension brackets include the different installation heights and the type of perforation, depending on the application.

To secure aligned components against shearing forces, we also developed the shearing plate, which can be put to versatile use and used to cover all possible anchoring cases.

Our product range also includes several variants of the tension straps for creating wood/wood, wood/concrete and steel/wood connections. Special holes for screwing at an angle of 45° make the tension straps particularly efficient and unique.

The Eurotec tie bar is used to transfer tensile forces to enable quick and easy base point anchoring of wooden elements in wooden, steel or concrete substrates.

© Stora Enso

We've got the perfect solution to hand - every time!

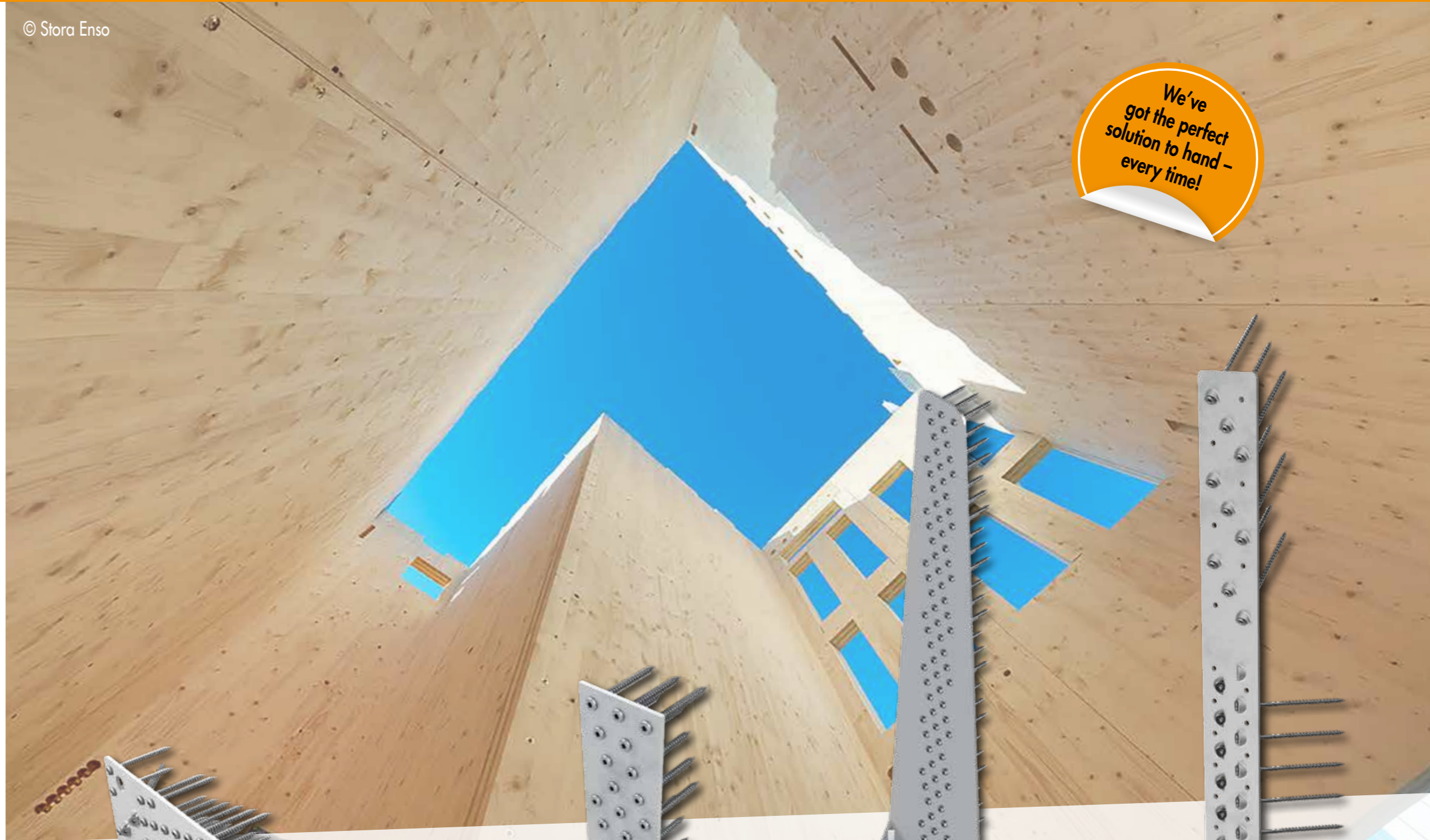
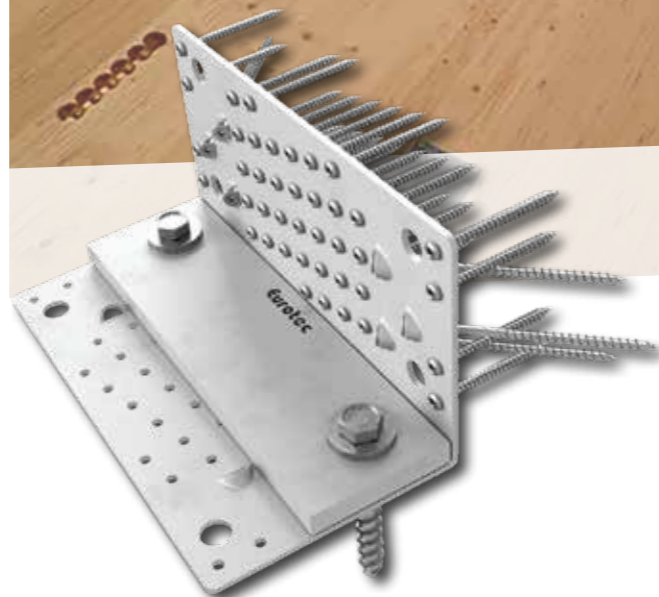
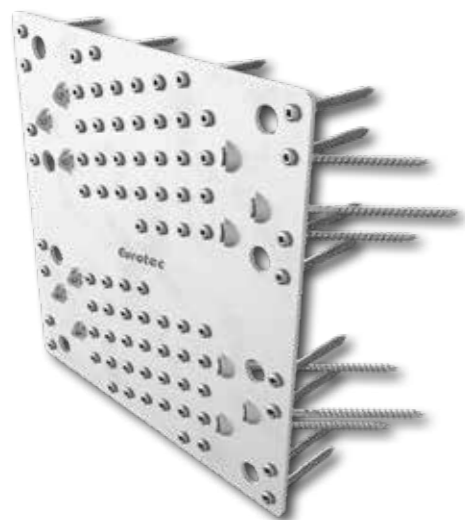

A new era of wood connectors

We offer a solution for every load case occurring in solid wood and timber frame construction in the form of brackets, straps, hook connectors or beam girders. We can assist with technical approval if necessary.

We are currently working flat out on unique solutions for system connectors. This solution is a system of all kinds of connections in modular and system design.

Our optimised screw patterns enable absorption of high tensile and shearing forces, so fewer connectors are required.

Make the most of the economic advantage!

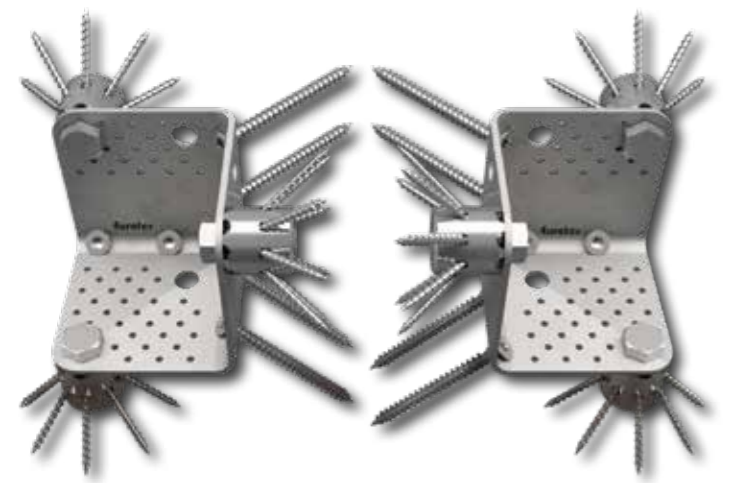
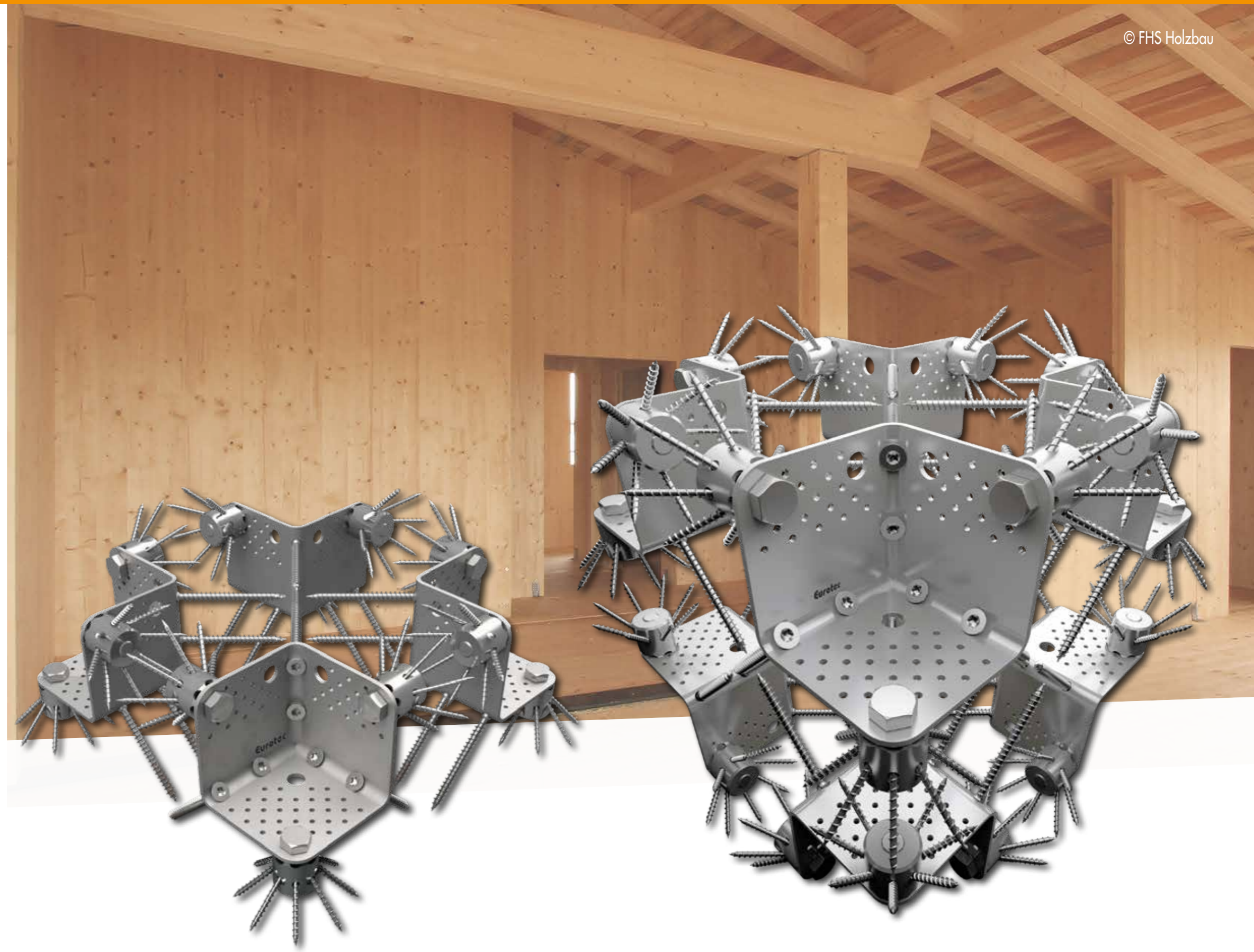



System connections for cross laminated timber structures

When used in combination with the appropriate connectors, our system bracket and inside corner form a system connection for almost all applications.

Enormous loads can be transferred thanks to our KonstruX fully threaded screws in combination with the Ideefix 40, with metric bolts or, alternatively, with angle bracket screws. The low level of prefabrication and quick assembly make our system a very effective system solution for solid wood structures.

© Stora Enso

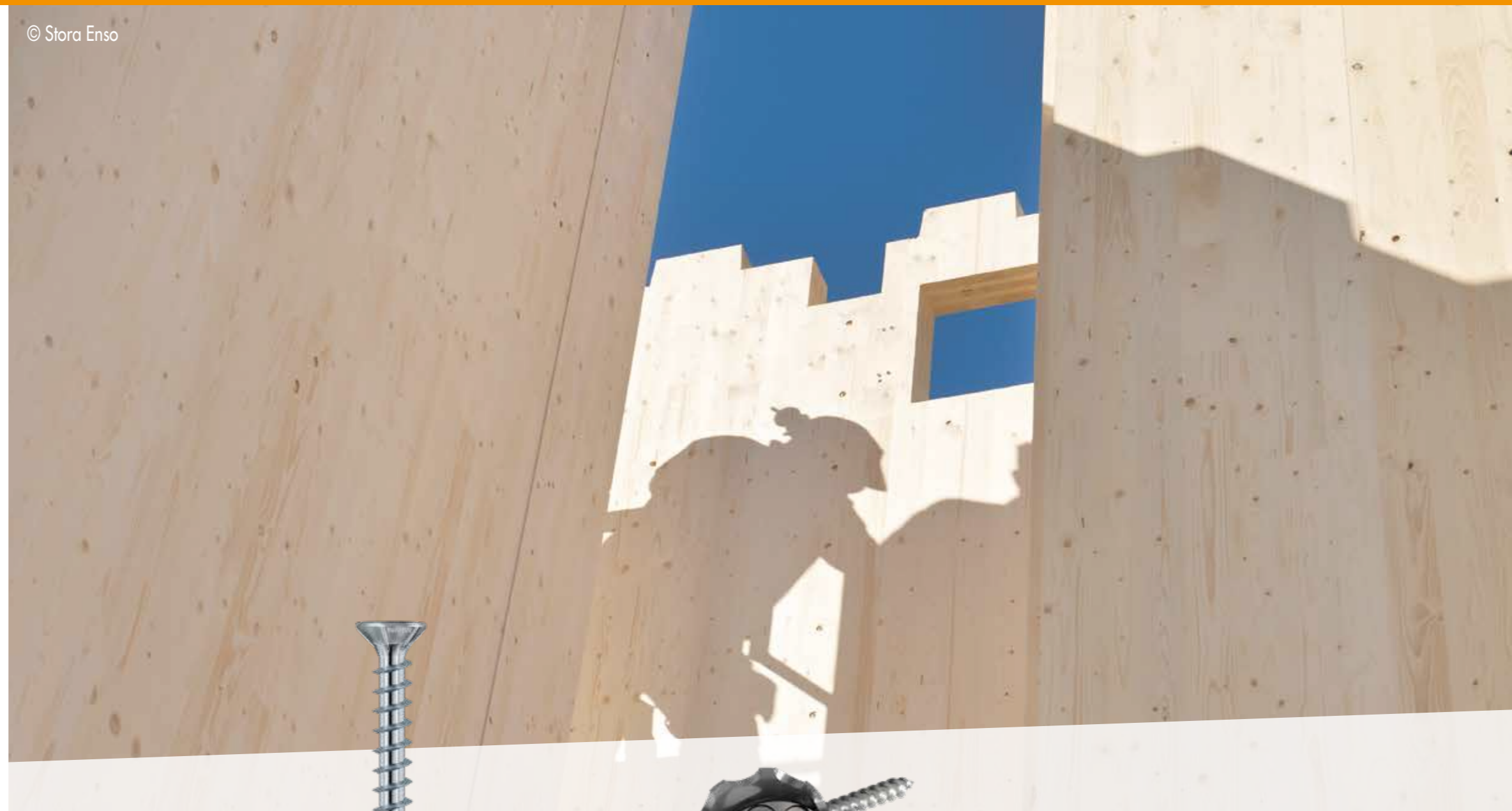

■ System bracket



■ Inside corner



■ KonstruX fully threaded screw



■ Ideefix



■ M16 hexagon head screw

Possible applications

Wall and ceiling anchor for solid wood walls and ceilings

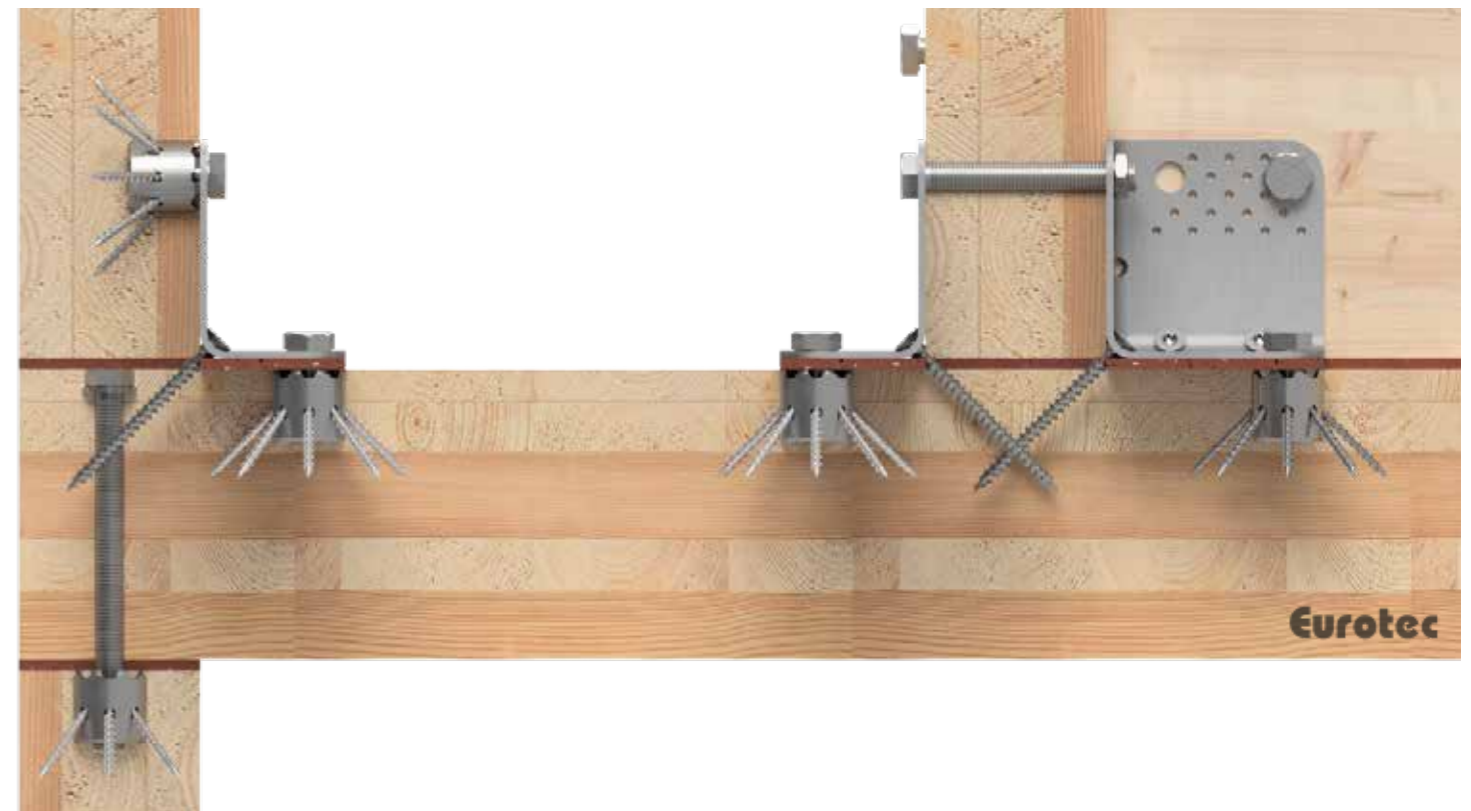
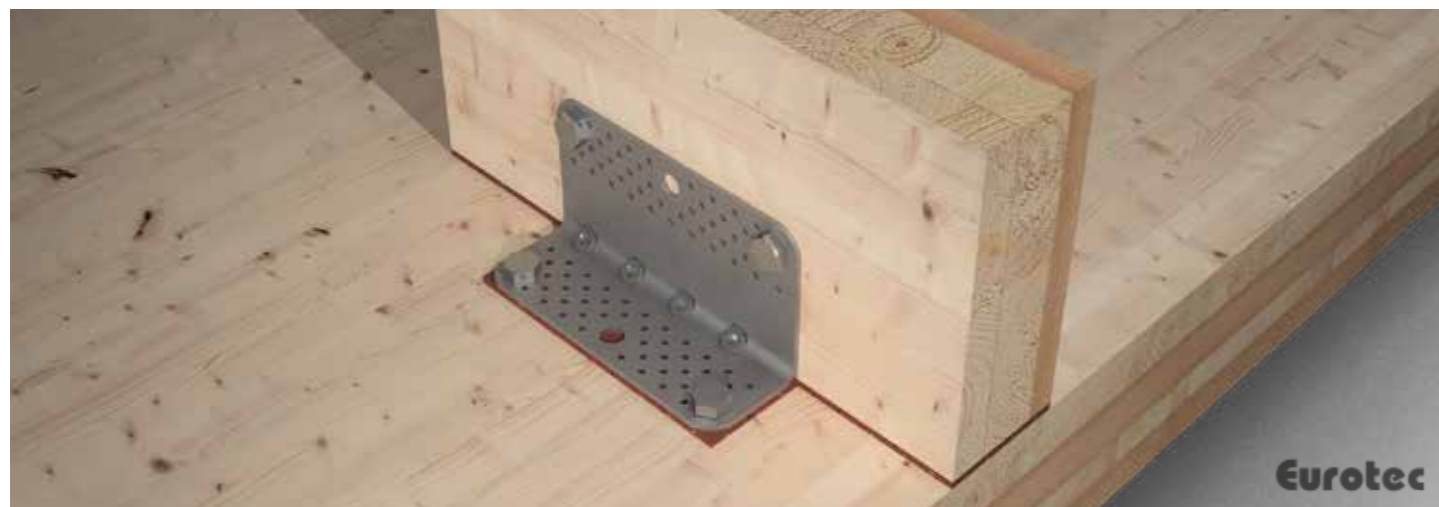
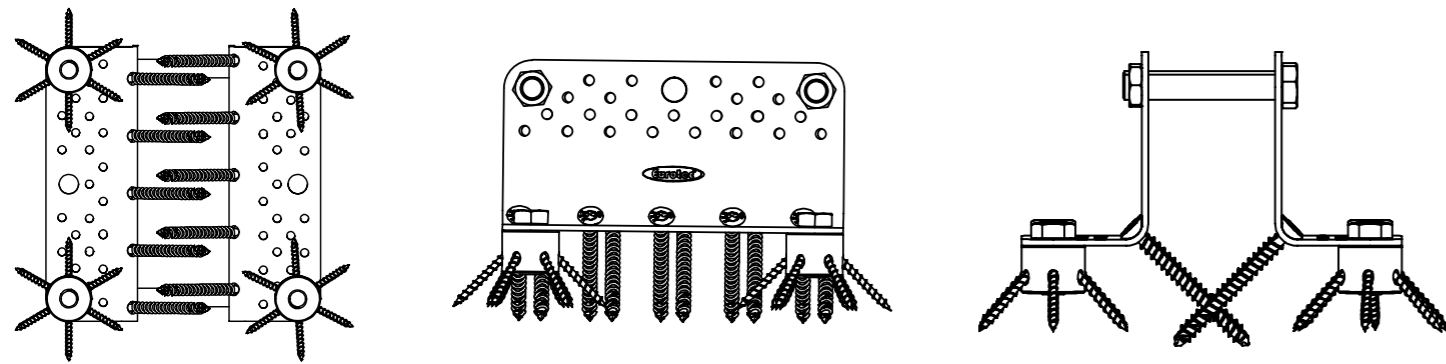
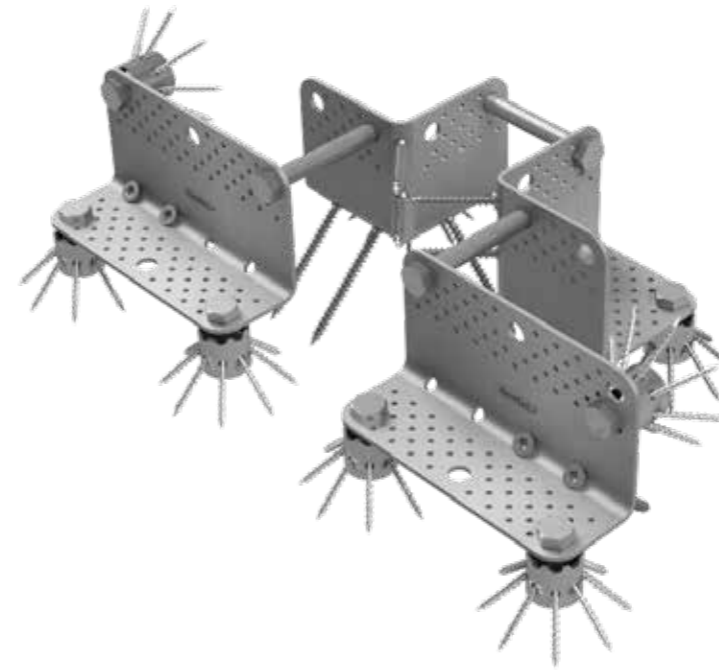
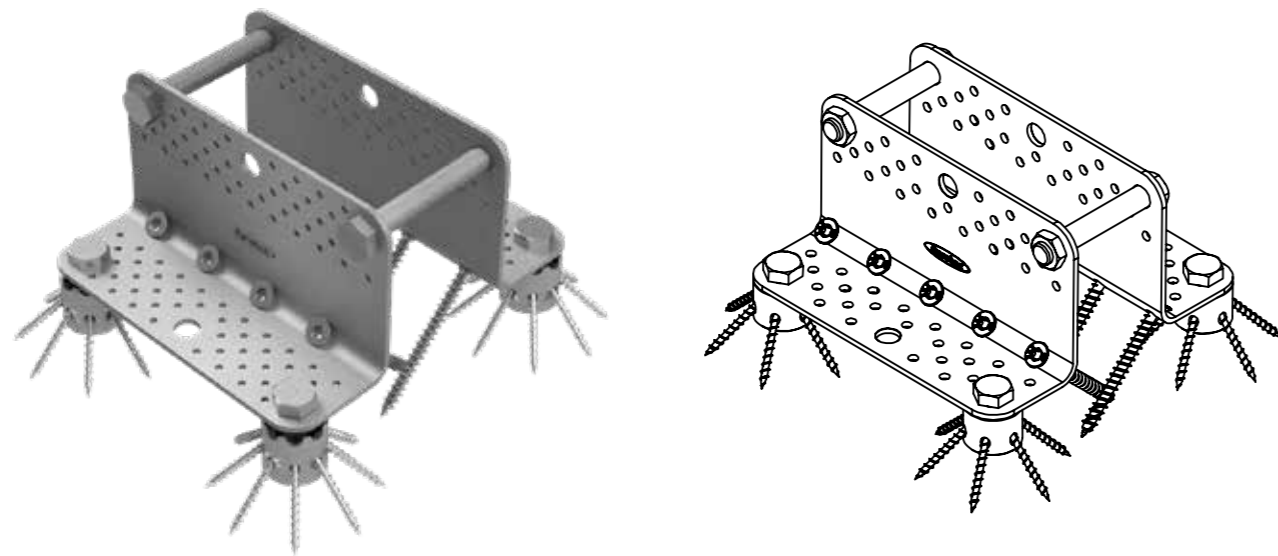

Wall – ceiling junction

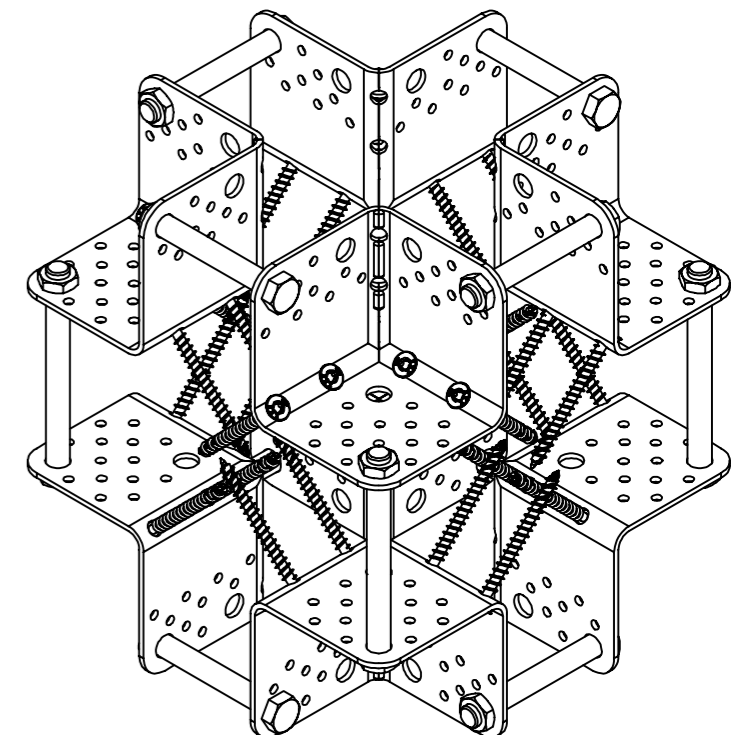
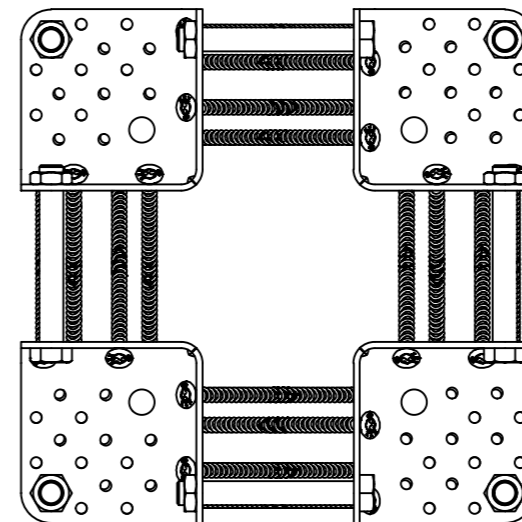
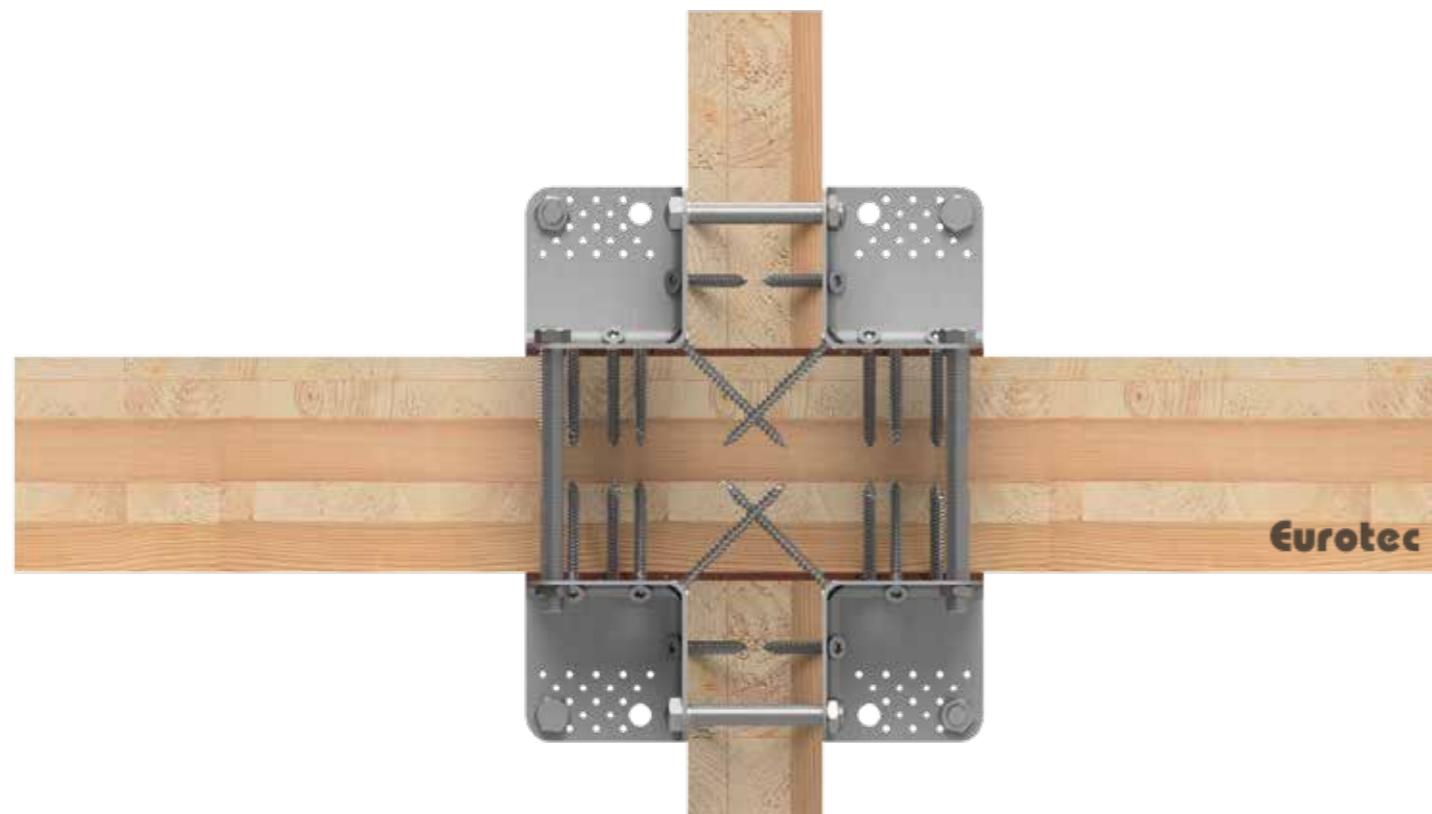
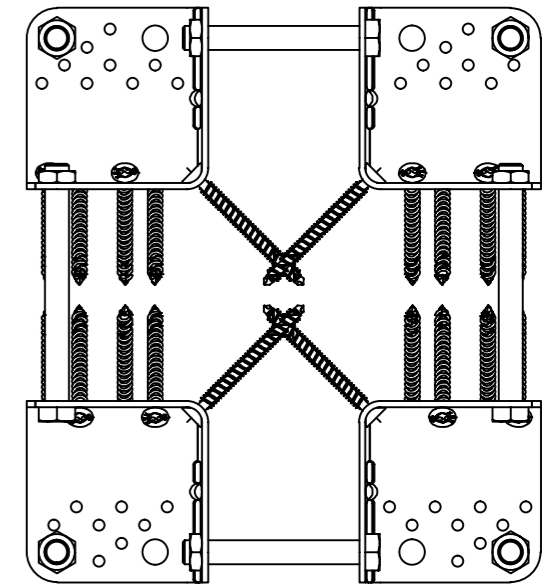
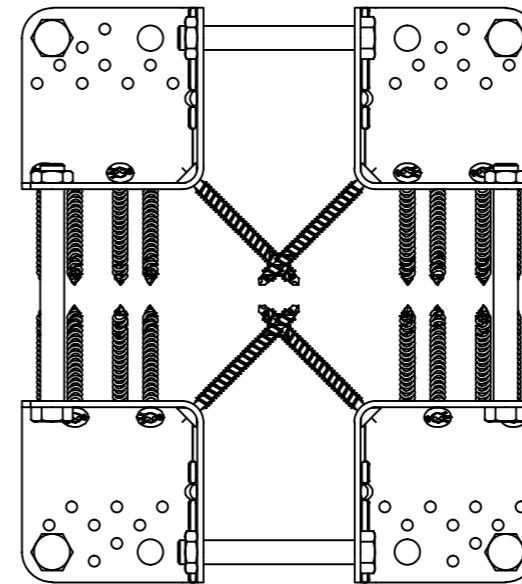
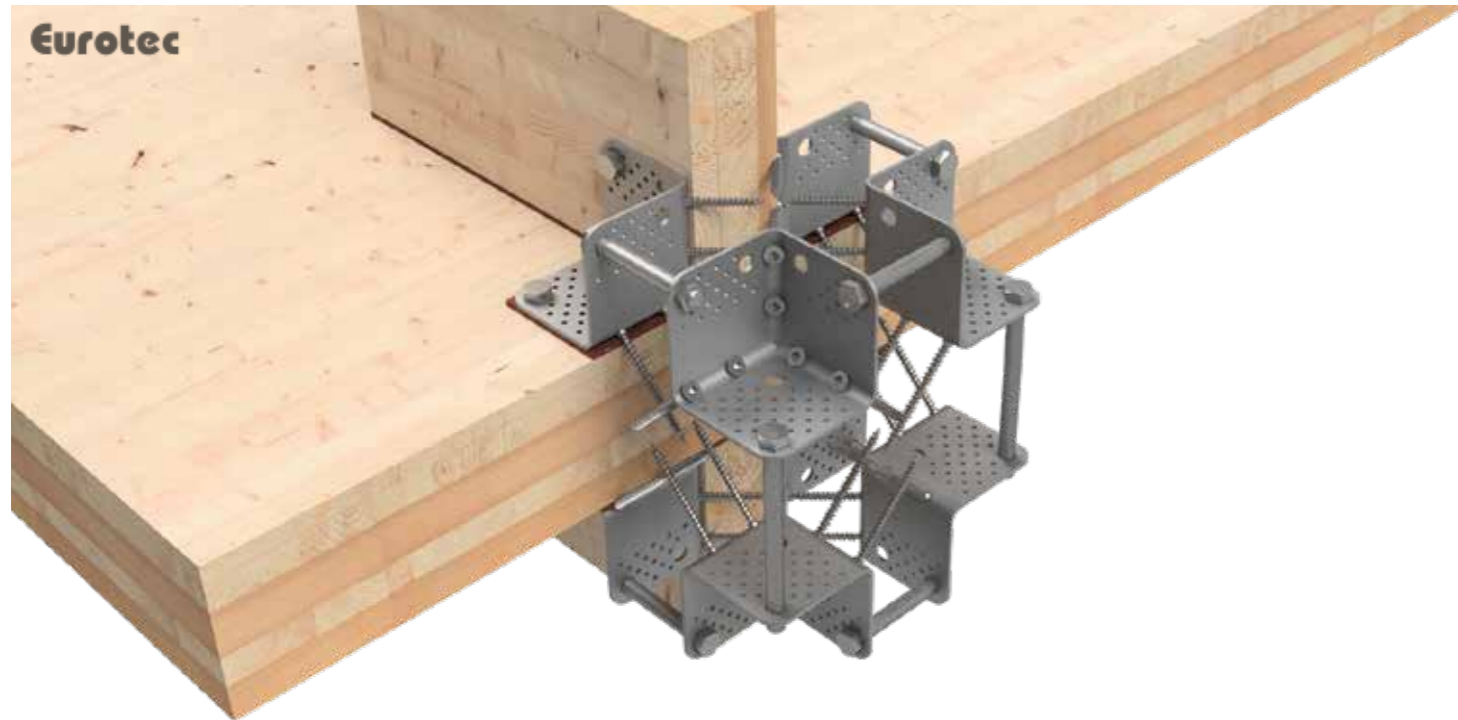

Corner bracing in the tension and shearing direction

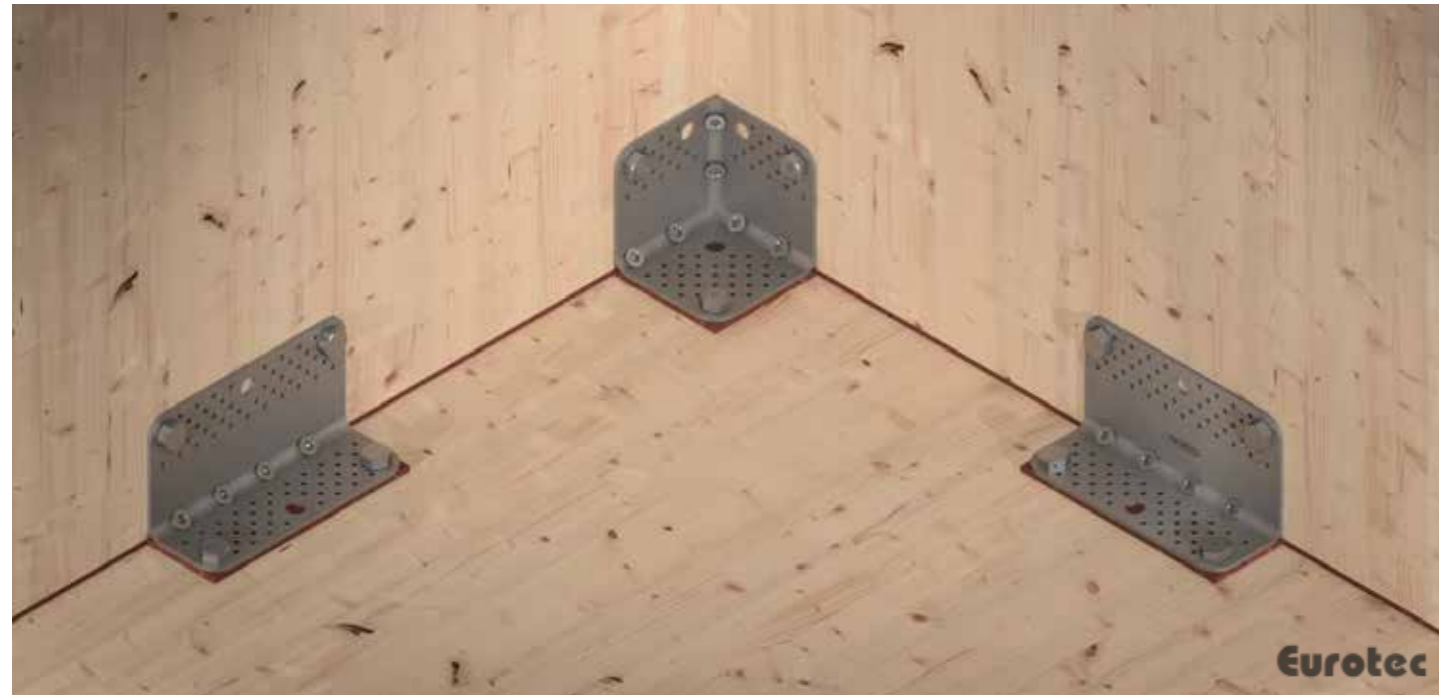

Cantilever structures

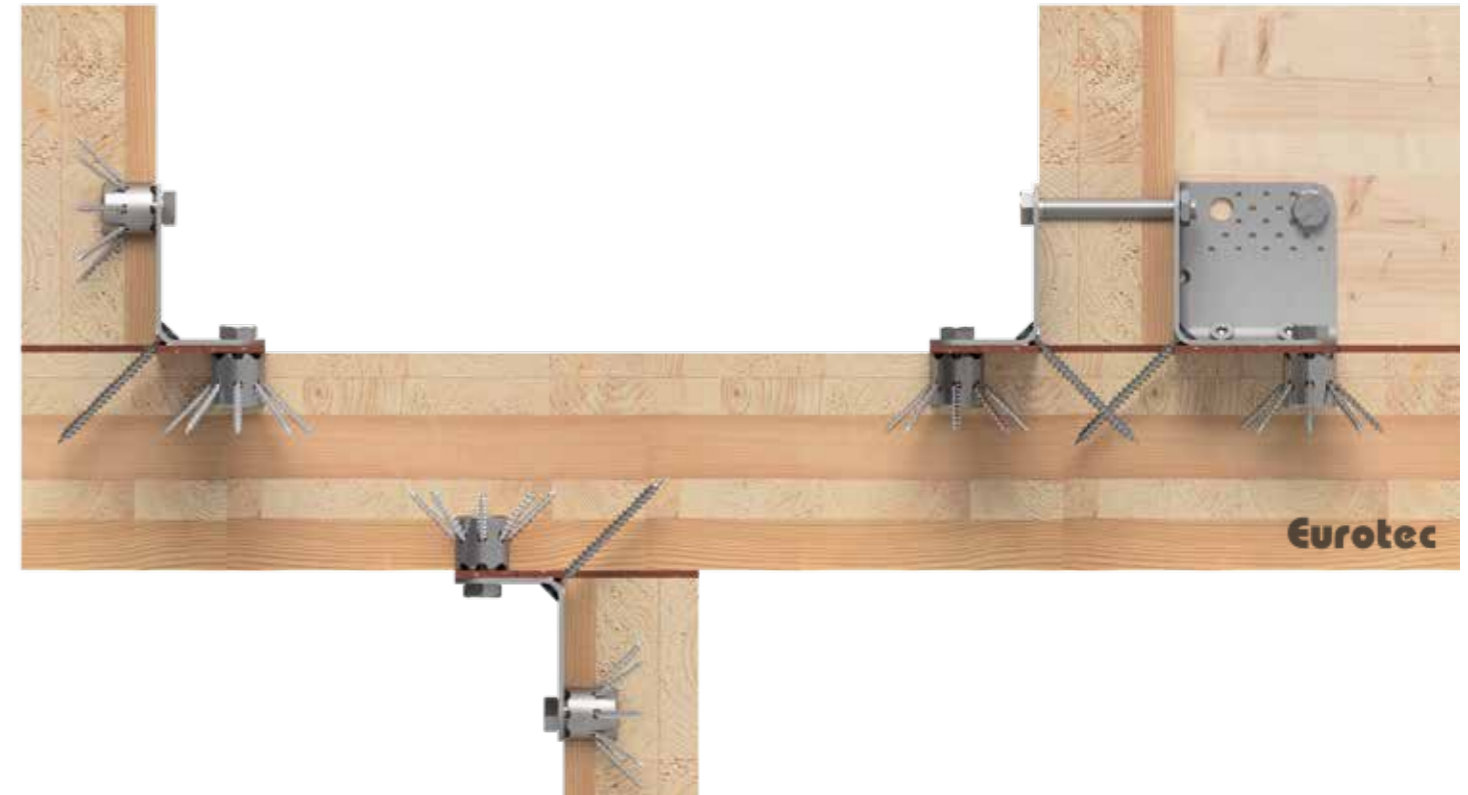

Building recess

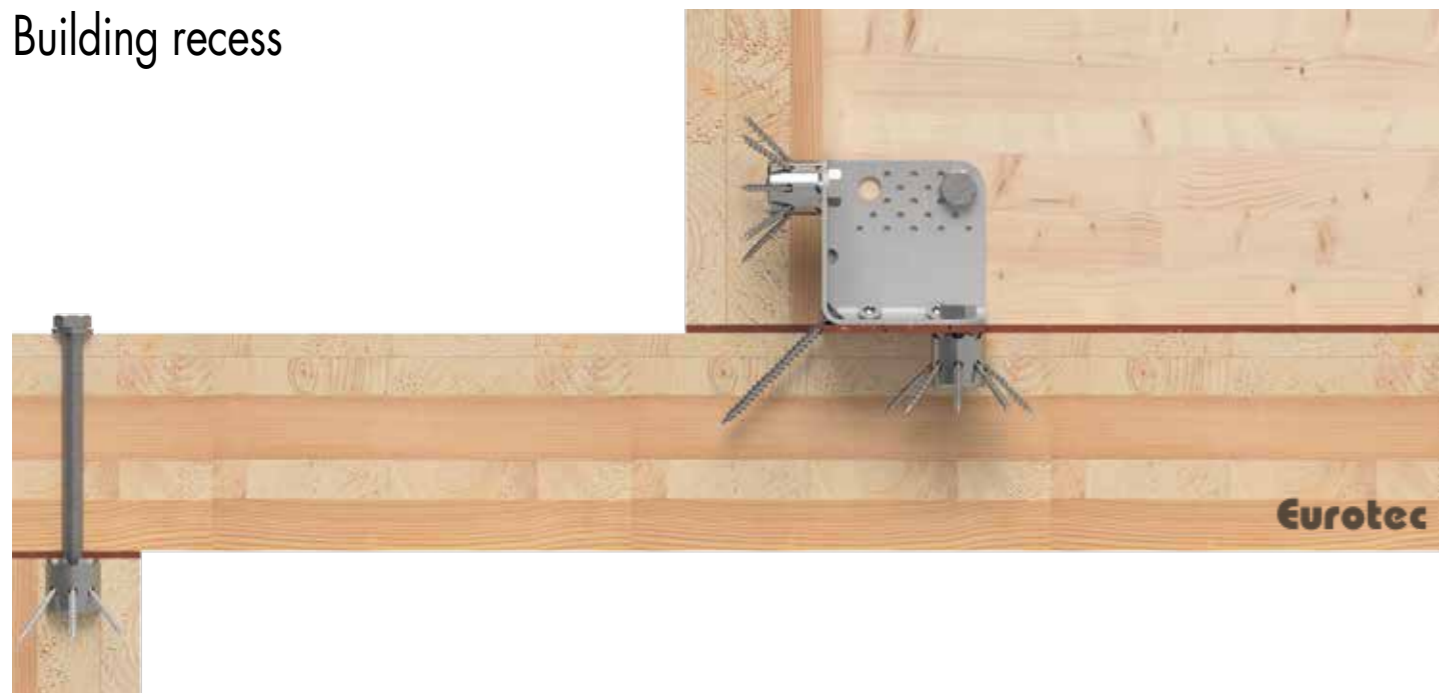

Wall junction – visible solid wood ceiling

