



## **COMPLETE PROGRAMME**

Timber | Deck and Garden | Roof | Façade | Concrete

More than  
**20**  
YEARS  
of quality







2 - 11

Eurotec introduces itself

12 - 143

Deck construction and landscaping

144 - 277

Timber engineering

278 - 335

Wood construction screws

336 - 347

Wood connector

348 - 385

Tools and aids for construction with timber

386 - 411

Concrete and masonry anchors

412 - 439

Roof and Façade

440 - 441

Index

443

General Conditions of Sale and Delivery

# Milestones

**1999**

The two managing directors, Gregor Mamys and Markus Rensburg, founded Eurotec GmbH on 1 May 1999. The company began its life in a small basement with an adjoining garage, whose 5 pallet bays served as a warehouse.

**2003**

After multiple relocations within Hagen, the decision was made in 2003 to move to a company building in Werkzeugstraße. At the time, the warehouse had space for approx. 300 pallet bays.

This warehouse also quickly became too small. After several expansions, capacity ran out and it was time for a new company building! The managing directors looked for and found a suitable location in Hagen.

**2007**

In 2007, the Eurotec team and its 30 members of staff moved into the new building at Unter dem Hofe 5. These newly built premises consisted of an office wing and an adjoining warehouse with approx. 3,500 pallet bays.

**2010**

Just three years later, the new building would, in turn, become the old building. A new warehouse building was built, providing a further 7,500 pallet bays and offices upstairs.

**2012**

In 2012, we decided to take the next important step. The foundation stone was laid for the production hall, paving the way for in-house production.

**2013**

From 7 January 2013 onwards, we produced a selected part of our proprietary product range in our own production hall in Hagen.

**2014**

In 2014, intensive work began on further expanding in-house production.

**2015**

Production capacity is expanded in 2015 to enable us to offer a wide range of solutions from our very own production facilities.

**2016**

In 2016, the company starts actively to build a new hall to relocate its machinery. Additional office space is being created in Hagen, since the company is enjoying steady growth. The next step is to expand the storage capacities in what was formerly the machinery hall.

**2018**

Completion of the new production hall in early 2018 means that all of the machinery can be moved. In addition, space was obtained for even more parking spaces with the construction of an additional warehouse.

**2019**

Our plastics production operations will be expanded in February to include two additional injection moulding machines, bringing our total number of machines to four. Screw production activities are also being expanded to include another multi-stage press. So we now have five machines for screw production in total.

**2021**

Our machine inventory continues to grow. This year, we will be adding two further plastics machines to our collection. We are also extending our online services to include Eurotec Coach and the Eurotec BIM platform.

## About Eurotec

We are a medium-sized company engaged in the development, production and sale of products for the construction sector.

To this end, we supply products for the areas of timber-frame construction, deck construction and concrete fastening.

We supply specialist dealers across Europe, who are responsible for distribution to skilled craftsmen.

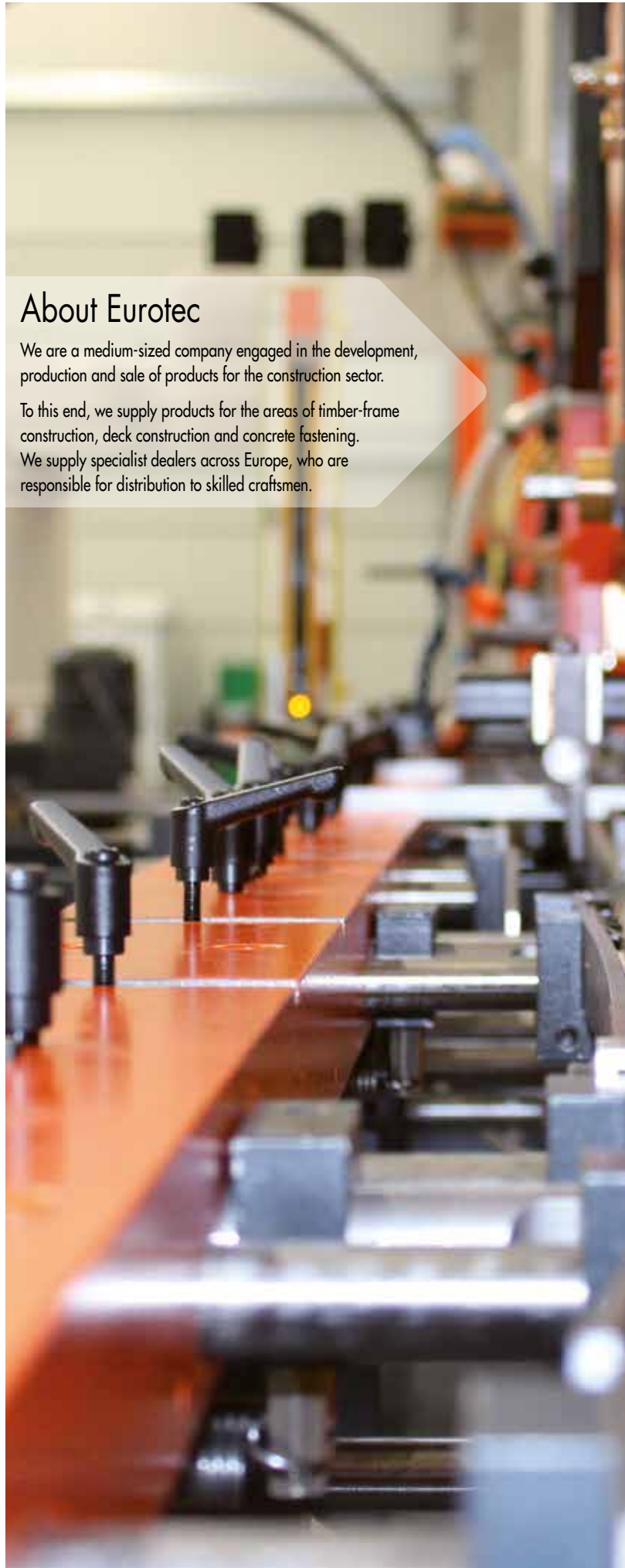





## In-house production in Hagen

When production began in 2013, we took an important step forward in the company's history. Our success and ever-growing production facilities show that we are establishing ourselves in the market with our products.

The benefits of in-house production are obvious, as we can better implement and constantly monitor our customers' high quality requirements. Short delivery times and swift responses to the demand of the market are additional advantages.

## Quality management

Quality forms the basis for all of Eurotec's activities. Offering our customers flawless products and services and ensuring 100% adherence to deadlines are our prime objectives.

We expect absolute dedication to quality from all of our staff. Priority is always attached to training and further development of customer- and quality-oriented thought and action. We are committed to complying with statutory and official requirements within an economic framework while promoting an environmentally conscious approach.

## Quality from Europe – and we're proud of it!



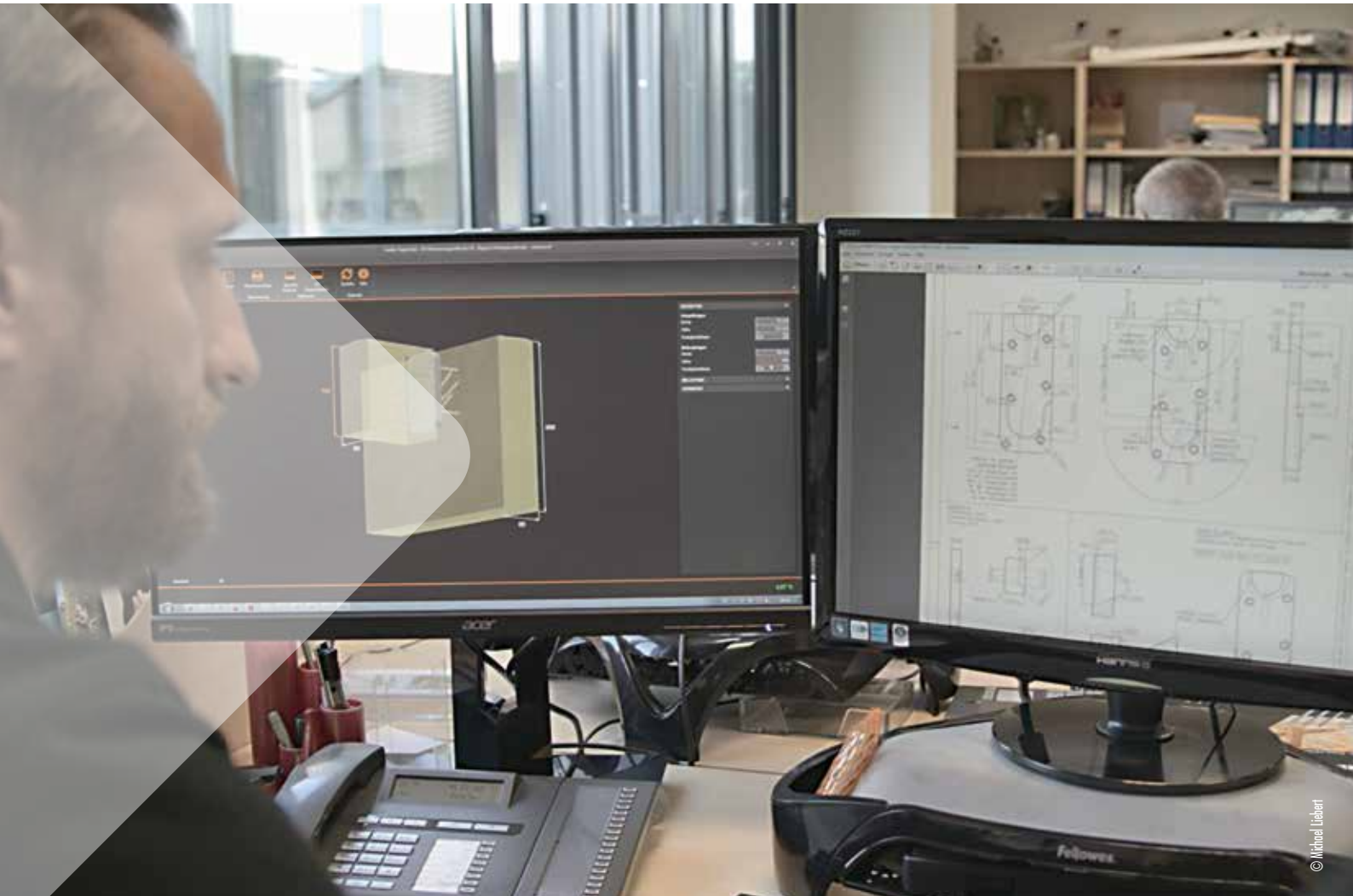

© Michael Liebert

## Our technology and engineering department

Our customers receive a complete package with an emphasis on product quality.

Many of the processes and operations that other companies outsource to service providers are carried out in-house.

By doing so, we ensure that you receive everything from a single source and that you have direct contacts within our company for your projects.

Originating from diverse areas of construction, our specialists produce designs in 2D or 3D, order and inspect initial samples, submit applications for certifications, make patent applications, issue approvals, monitor batch production, and much more.

All items in the core product range are certified by an European Technical Approval and test reports that are vital for the construction sector, reflecting our high quality standards.

In addition to this, we also offer a broad portfolio of services. These vary from free calculations for your construction projects to a wide range of sales aids such as sets of sample shelves and sample decking, as well as various application videos. We even offer training for your staff.

With our products, we either respond to the general requirements of the market or work with customers to develop solutions for specific areas.



# We would be delighted to advise you on your construction projects

Contact our technical department or use the free calculation software in the service section of our website:

[www.eurotec.team/en](http://www.eurotec.team/en)



## Calculations/planning in the deck and garden segment

- Quantity surveys and product recommendations for terrace construction
- Planning of special terraces, e. g. elevated terraces
- Installation diagram of terraces if necessary once an order has been placed
- Customised product developments for terrace construction

## Calculations/planning in the field of timber construction

- Overhead insulation with Paneltwistec and Topduo
- Main/secondary beam joints with KonstruX, Atlas, Magnus and IdeeFix
- Geometric/static bar panels with KonstruX, Paneltwistec and Topduo
- Support reinforcements with KonstruX
- Rafter/purlin joints with KonstruX, Paneltwistec and Topduo

## Calculations/planning in the concrete segment

- Fasteners in/on concrete components with rock concrete screw, bolt anchor and injection anchor

## Calculations/planning in the field of façades

- Quantity determinations for fixing façades and façade elements with EiSYS façade screws, Klimax insulation dowels, ERD frame dowels, Topduo and Paneltwistec

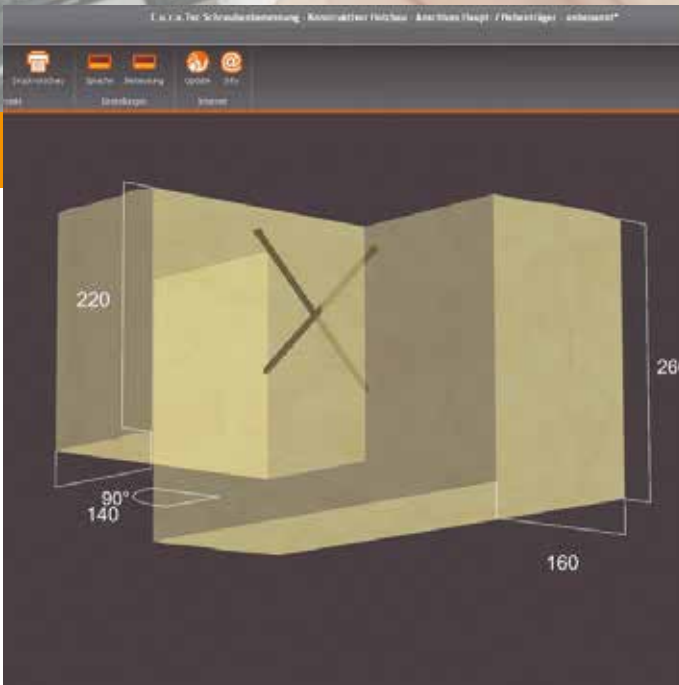

Your contacts can be reached by  
**E-Mail [technik@eurotec.team](mailto:technik@eurotec.team)**  
**Tel. +49 2331 - 62 45-444**

All information constitutes planning/design support and should be checked by a specialist planner if necessary!





## Injection moulding



We are able to put our many years of experience in the area of injection-moulded plastic parts to use at the Hagen site too. Our product range includes multidimensional injection-moulded parts.

With our modern machinery, we can process a wide range of thermoplastics, tailoring them to different requirements and applications. We are able to produce all kinds of plastic parts – **not just industry-specific products**. Our machines operate with holding forces of 30 to 220 tonnes.

All of the machinery was moved to a new production hall in early 2018 due to continuous expansion.

**Eurotec's production is always environmentally conscious**

100% of rejected and defective parts are recycled, and the crushed material is processed again.







## Stamping and stampingbending technology

### Flexible production with best quality.

Another area of expertise lies in stamping and stampingbending technology. With this technique, we produce customer-specific solutions for a wide range of applications for customers around the world.

For this, we have eccentric presses at our disposal with a compacting force of 40 to 400 tonnes and a maximum stroke frequency of 400 strokes per minute. Strip widths of up to 500 mm and strip thicknesses of 0,15 – 8 mm are possible. Production is primarily carried out in coil form using progressive tools that were designed in-house.

In addition, our experts will be happy to advise you on material and surface selection. There is a wide range of possible variants and designs, so that we can identify the optimum solution for each area of application.

The focus here is always on close cooperation with our customers in order to satisfy their wishes and requirements as well as possible.

Whatever your requirements are, we provide you with everything from a single source.



© Michael Liebert

© Michael Liebert

© Michael Liebert





## Cold forming

### Quality from Germany – and we're proud of it.

Since production began in 2013, we have constantly expanded our production facilities in order to manufacture an ever-greater proportion of long-shafted cold-formed parts in-house at our location in Hagen. For example, these also include various special-purpose construction screws, such as the KonstruX fully threaded screws or the Topduo roofing screws.

At our production plant, cold-formed parts are produced with a diameter of up to 10 mm and a length of up to 1,000 mm. One particularly economical feature is that our machine allows us to automate up to eight machining processes. The relocation of the production facilities to a bigger hall meant that this area was also expanded to include additional machines.







## Eurotec as a strong partner

Eurotec has taken up the task of manufacturing products to develop a solution that provides the professional user with an offer the highest degree of advantages and innovative edge. Thereby, individual products are always developed in close cooperation with the customer.

The core assortment consists of screws and fastening systems for the building materials timber and concrete as well as high-quality substructures and fastening systems for terrace construction.

It is the company's declared philosophy that not the price, but rather the quality of the products is in focus. That the price-performance ratio is ideal is attested to by a steadily growing customer base of more than 4,000 customers worldwide.

Take advantage of the wide range of products on offer.



We look forward to working with you as partners!







## Deck construction and landscaping

Terrace handling instructions	14 - 17
Selecting screw steels based on their corrosion resistance	18
Overview of timber types	20 - 26
Information about our service	28 - 33
Accessories for decking substructures	34 - 37
Eurotec Stone System	38 - 39
Eurotec adjustable pedestals	40 - 48
Aids for installing stone slabs	49 - 51
Robusto deck pedestal	52 - 53
Eurotec aluminium profiles	54 - 75
Edge joints	76 - 87
Hidden fastening accessories	88 - 102
Visible fastening accessories	103 - 106
Screws for terrace construction	107 - 117
Aids for laying decking boards	118 - 124
Accessories for wooden façades	125 - 129
Wood connectors and fittings	130 - 139
Eurotec sales shelves	140 - 143



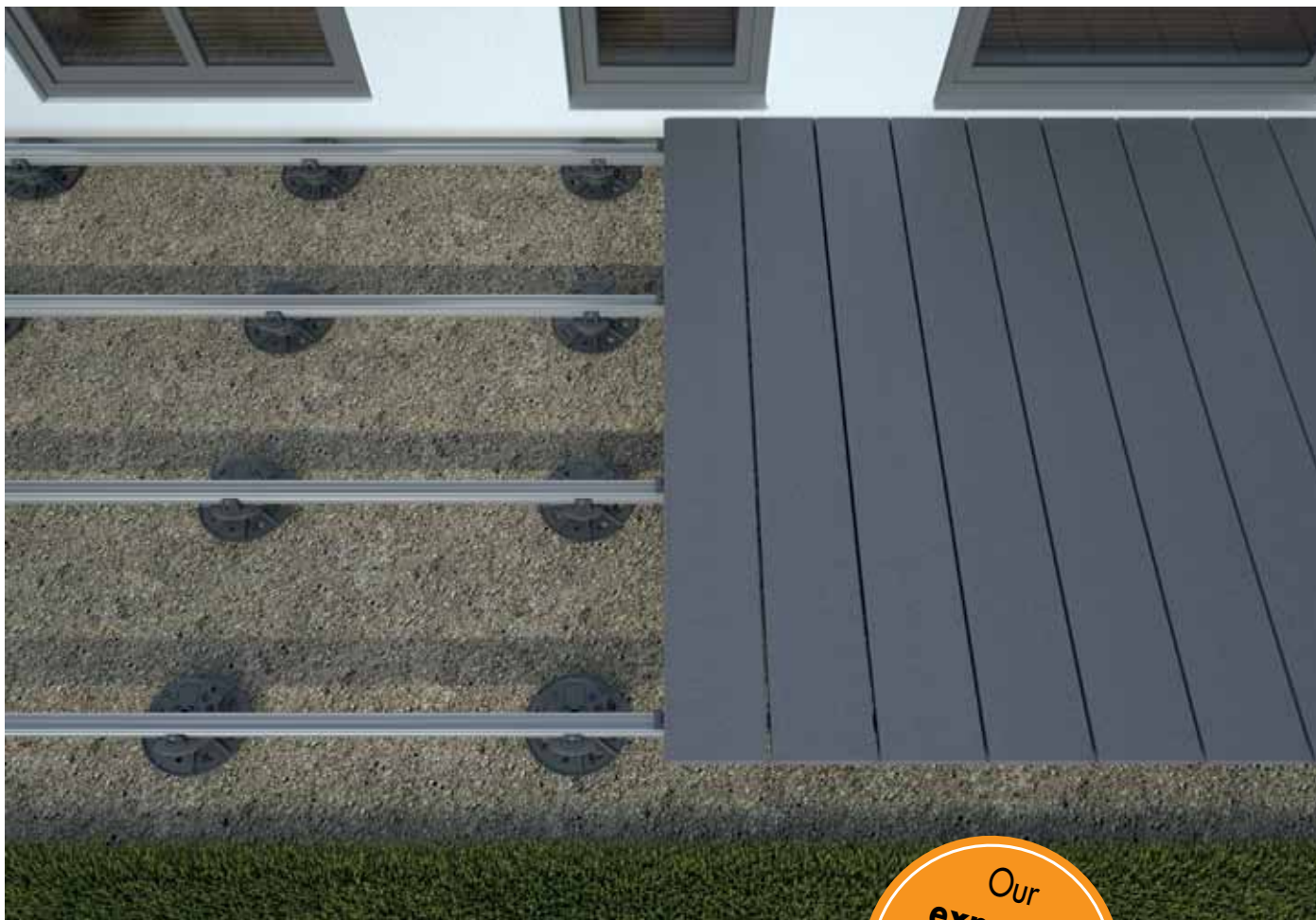

## Proper surface for adjustable pedestals

**If you want to build/create a viable and permanently reliable terrace, the condition of the subsurface significantly contributes to the success of the project and should therefore be prepared carefully in advance.**

If no foundations are available, we recommend to use adjustable pedestals. For a properly designed terrace construction, a load-bearing substrate made of gravel, split or floor slabs is required. These can absorb arising loads in the soil.

Before the substructure made of aluminium profiles or support beams are laid.

- A supporting structure is required. Appropriate preparations must be made for loose subsurface.
- Stake out the planned area and remove any natural soil, such as turf, rocks and weeds.
- Remove the top layer of soil that contains humus and soil-dwelling organisms in addition to inorganic substances.
- If the topsoil is removed, dig out a 20 - 30 cm deep bed. Fill with crushed gravel or chippings and compact each layer separately to ensure a stable substrate.
- Here, too, a gradient of 1 - 2% to the garden should be considered.

- Pure sands and gravels are not recommended as they are not based on the displacement of the individual grains.
- Lay concrete slabs of approx. 30 x 30 cm at the same distance as the foundation.
- If there is risk of impact vibration on the decking, the decking pedestals should be secured in place. In addition, decking pedestals that are frequently subject to stresses should be secured by screws to avoid twisting.

**Please note that the mentioned processing instructions are only recommendations and are not binding installation instructions.**

**Each assembly has different requirements, for which the executing company is responsible.**

**In order to determine the strength of the superstructure, it is important to determine the expected load on the terrace. Thus, paths with no vehicle traffic do not require a supporting layer, or you can choose to use one with a very low strength (10 - 20 cm). Stronger layers are required for busy paths.**



First, the area is measured in the terrain (position, slope) and marked. Work is carried out on each of the sides, approx. 10 cm beyond the width of the deck to stabilise the surface edges. Good topsoil can be stored on heaps for further use on the planting areas or removed with the entire excavation work.

### Planum

After digging, the subsurface (soil, natural ground) is levelled out, possibly improved (stabilised) and compacted. The flatness of the substructure is necessary to prevent the collection of water in uneven and sinking ground, which can later lead to lowering of the superstructure.

#### • Example for the improvement of the substrate

Too higher water content compensated by coarse gravel or burnt lime, in case of unfavourable grain composition (e.g. gravel 8/16, 16/32) incorporate missing grain sizes can be.

### Frost protection layer

If necessary, an antifreeze layer can be installed, which consists of gravel-sand or grit-sand mixtures of grain size 0/32 and should have a minimum thickness of 10 cm. After installation, the compacting of the layer takes place. At the same time, it also serves as a granular subbase, which prevents indentations of the base layer in the substructure.

### Base layer

This is followed by the installation of the base layer.

- Absorption and distribution of the traffic load
- Material: Mineral gravel or recycled material with grit sizes 0/32, 0/45, 0/56. No zero-components if enhanced water permeability **mineral concrete** is required, e.g. under a mosaic pavement or plate coverings under a heavy load

The thickness of the base layer depends on the expected load.

After the gravel has been installed (compression factor 1.3), this is levelled, first a rough plan with the spade is made, followed by a fine planum with a rake.

In this case, slopes (generally, 2% is sufficient) are observed. For terraces with garden access, the water can usually be led into the neighbouring beds, depending on the width of the path, a roof slope can be planned. Longitudinal gradients mostly result from the conditions of the terrain. For thicker layers, the compaction takes place layer by layer every 20 - 25 cm. In order to prevent the gravel from separating, it is installed and compacted when it is moist.



# Processing instructions Terrace

## Substructure

A properly executed substructure is of great importance for a stable and durable wooden terrace. On the one hand, it has the task of supporting the actual decking, so that a flat surface is maintained even under a heavy load. On the other hand, it serves as the constructive protection of wood by creating a distance between the ground and decking/wooden supports. The wood is thus neither exposed to waterlogging or increased wood moisture in the ground-air zone.

Waterlogging and increased moisture content coupled with the use of unsuitable wood species would create a breeding ground for wood-destroying organisms.

In the following, we would like to show you various approaches to the construction of a terrace substructure.

A supporting ground is required. This can be compacted soil or gravel as mentioned before. This is where the foundation rests on. The support timbers are laid on these.

The foundations create the above mentioned necessary distance between soil and wood and remove the emerging loads.

## Here are three examples for the installation of substructures

- 1 A strip foundation is poured into concrete. This is very expensive and requires very accurate work.

- 2 Concrete elements are laid in a gravel bed. These are relatively difficult to transport and position.

In the versions 1. and 2. a problem becomes clear: You have to work very precisely to bring the top edges of the foundations to exactly the same height. Since this is usually not possible, the supporting joints must be later relined.

The **Rolfi spacers** (p. 36 - 37) are particularly suitable for this.

- 3 **Adjustable pedestals by Eurotec**  
The adjustable pedestals can be placed directly on compacted ground or on concrete. The time-consuming construction of the foundations and the relining of the substructure wood for height adjustment. The height can be infinitely adjusted together with the supporting joint, which is connected by a bracket directly to the adjustable pedestal.







© NATURinFORM

## Expert hints

# Hazards in the construction of timber decks

The various timber types differ from one another not only in their appearance but also in their technical properties:

- One particularly important property of wood with regard to deck construction is dimensional stability (also known as "resilience"). Experts use this term to refer to the property whereby wood changes shape in the course of use due to swelling or shrinkage. The various timber types show different degrees of dimensional stability. For this reason, special attention must be paid to the choice of the timber type. For deck construction, we recommend using timber with high dimensional stability. Some timber types, including Massaranduba, exhibit lower-than-average dimensional stability, so we explicitly advise against using these timber types for deck construction. Since, from an absolute perspective, the swelling and shrinkage behaviour increases as the width of the timber boards increases, we also recommend a maximum board width of 120 mm. You can find details of the dimensional stability of some common timber types in the "Overview of timber types" on p. 20 - 26 of our catalogue.
- Rift-sawn planks should always be used in preference to flat-sawn planks, as they have considerably better properties with respect to cracking, splintering, swelling and shrinkage, as well as dimensional stability, and therefore tend to distort and warp less. Often, so-called flat-sawn planks cannot be fastened permanently with either visible or hidden methods. In such cases, we cannot guarantee permanent fastening.
- Even fine particles of abraded metal can lead to dark spots of corrosion on the timber boards. Metalwork should not therefore be carried out in the direct proximity of the deck.
- Constituent substances in the timber can cause contamination of adjacent surfaces; it is therefore important to take constructive precautions, such as maintaining sufficient distances from nearby components.
- As nature does not adhere to quality guidelines, the suitability of timber for deck construction does not depend solely on the timber type. Often, problems can occur even due to individual batches of a timber type that is normally harmless. Possible reasons for this include spiral grain and insufficient drying.
  - Spiral grain refers to a wood grain that has grown in a spiral around the trunk axis; this becomes a problem if, in the course of use, the moisture contained in the wood deviates from the moisture level at installation. If this happens, internal tension in the wood is released and can therefore cause the

deck boards to warp. The energy released in this process is so enormous that it often impairs even perfectly installed fastening systems.

- It is a property of every timber to be able to absorb and emit water. For the user, this property can primarily be perceived through the timber's swelling and shrinking. One task of the timber trade is to bring timber to the correct state of dryness for the respective area of use. If timber is used that has an incorrect moisture content at installation, this can quickly lead to damage.
- Many properties of the timber vary strongly depending on the grade. It is therefore advisable to contractually stipulate all criteria in advance with your timber dealer!
- Particular care should be taken when purchasing Bangkirai. In the past, increased demand often meant that substitute timber from South East Asia was – knowingly or unknowingly – traded as Bangkirai. Most of these substitute timbers are considerably less suitable for deck construction. This results in cracking, strong warping and bending of the boards.
- It is essential to use identical timber types in order to ensure the durability of the deck – i.e. the upper deck and substructure must be made of the same material.
- **Application of bits made of stainless steel**

When setting screws, it inevitably always leads to a little abrasion between the screw drive and bit. This abrasion can lead to discolouration of the wood surface and the screw head in outdoor applications or in wet rooms, when attaching wood rich in tannins. Mistakenly, this is often attributed to the screw, even if it is made of stainless steel. In order to avoid the risk of discolouration due to extraneous rust, stainless steel bits should also be used for setting stainless steel screws!

**A lot of damage to deck structures can be prevented in advance by thoroughly inspecting the timber that is to be installed. If, for example, the tradesman responsible already notices deformation in the deck boards before installation, none of these boards should be installed.**

# Selecting screw steels based on their corrosion resistance

## Step by step

Select the right screw material for your project by observing the following principles. Go through the three points one after the other. The right material is marked for points 1 and 2 with (X) at least, or even better with X. In the event of additional chemical stress, point 3 must conform as well.

1. What's the component's situation? Is it exposed to the weather (fence) or is it protected (ceiling beam)?
2. Which wood is being fastened? Is it simple construction wood, or tannin-rich tropical wood?
3. Are there any additional stresses in situ that encourage corrosion? Location near the sea? Heavy industry, etc.?

### Example: fastening a façade made of Douglas fir

1. Use class = 3, because exposed to weather. Façade = optical requirements. → at least C1
  2. Douglas fir → min. C1, but an A2 or A4 is to be preferred.
  3. This point is not required, because there are no further external stresses.
- Selection: C1 is possible, but A2 or A4 is to be preferred.

Steel group	Carbon steel		Stainless steel, martensite	Stainless steel, austenite	
	Electroplated	Special coating	C1; hardened stainless steel	A2	A4
Product examples	Panelwistec blue/yellow Hobotec blue/yellow	Panelwistec 1000 Topduo	Terrassotec stainless steel, hardened Hapatec	Terrassotec A2	Terrassotec A4 Hapatec Heli
<b>1. Position of the component?</b>					
Service Class (NKL) 1 <sup>a)</sup>	X	X	X	X	X
Service Class (NKL) 2 <sup>a)</sup>	X	X	X	X	X
Service Class (NKL) 3 <sup>a)</sup>	-	(X) <sup>b)</sup>	X	X	X
<b>2. Which wood? <sup>d)</sup></b>					
Structural timber, wood materials <sup>a)</sup>	X	X	X	X	X
Beech (red beech)	X	X	X	X	X
Douglas fir	-	-	(X) <sup>e)</sup>	X	X
Spruce	X	X	X	X	X
Pine	X	X	X	X	X
Larch	-	-	(X) <sup>e)</sup>	X	X
Coniferous wood, pressure-impregnated	(X) <sup>b)</sup>	(X) <sup>b)</sup>	(X) <sup>b)</sup>	(X) <sup>b)</sup>	X
Red cedar	-	-	-	(X) <sup>f)</sup>	X
Fir	X	X	X	X	X
Thermotreated wood from coniferous wood	-	-	-	(X) <sup>f)</sup>	X
Abachi	-	-	-	(X) <sup>f)</sup>	X
Afzelia, doussié	-	-	-	(X) <sup>f)</sup>	X
Azobé, bongossi	-	-	-	-	X
Bangkirai, balau	-	-	(X) <sup>e)</sup>	X	X
Bilinga	-	-	-	(X) <sup>f)</sup>	X
Courbaril, jatobá	-	-	-	-	X
Cumarú	-	-	-	(X) <sup>f)</sup>	X
Sweet chestnut	-	-	-	-	X
Oak	-	-	-	-	X
Eukalyptus	-	-	-	-	X
Garapa	-	-	-	-	X
Ipé	-	-	(X) <sup>e)</sup>	X	X
Iroko	-	-	(X) <sup>e)</sup>	X	X
Itaúba	-	-	-	-	X
Kosipo	-	-	-	-	X
Massaranduba	-	-	-	-	X
Merbau	-	-	-	-	X
Robinie	-	-	-	-	X
Thermally modified timber made from hardwood	-	-	-	(X) <sup>f)</sup>	X
<b>3. Additional chemical load?</b>					
Constant condensation <sup>g)</sup>	-	-	-	(X) <sup>b)</sup>	X
Salt load <sup>h)</sup>	-	-	-	(X) <sup>b)</sup>	X
Aggressive atmospheres <sup>k)</sup>	-	-	-	-	(X) <sup>m)</sup>
Chlorous atmospheres <sup>l)</sup>	-	-	-	-	-

- a) Use classes in accordance with DIN EN 1995:2008. NKL 1 - components in structures enclosed on all sides, partly heated. NKL 2 - components in roofed, open structures without direct weather exposure. NKL 3 - freely weathered constructions.
- b) Recommended only for less significant fastening points, or for temporary objects, or if there are no visual requirements.
- c) Pilot-drilling and, where applicable, pre-countersinking, is recommended in general for hardwoods. This also applies for coniferous woods in deck and façade construction.
- d) Untreated: spruce, fir, pine, composite timber, KVH<sup>®</sup>, veneering laminated wood, solid wood, etc., plywood, OSB, fibreboards, cement-bound and gypsum fibreboards, etc.
- e) In our experience, using this timber with C1 does not lead to problems with corrosion or timber discolouration. Depending on the origin of the timber, however, this cannot be ruled out completely. Please also inquire at your timber dealer.
- f) Use of A4 is recommended. Please contact your wood dealer as well.

- g) Uninterrupted condensation in a water vapour atmosphere with only slight impurities.
- h) Building components close to roads heavily affected by salting in winter, coastal areas, in offshore and other industrial installations.
- k) For example: building components in road tunnels, pig stalls or in other aggressive atmospheres, possibly with additional higher air humidity.
- l) Building components in indoor swimming pools or other chlorous atmospheres.
- m) Use to be checked in the individual case.

**This overview cannot take account of all applications. Materials can be assigned to more unfavourable conditions as well in an individual case.**



# Wood decks

Because of constantly occurring problems with the use of hardwood/tropical woods we want to point out some fundamental working guidelines that must be observed. However, we refer in general to the recommendations of your wood dealer, because there can be extreme fluctuations in the wood properties with the same wood type, above all with tropical woods. Bangkirai wood, for example, which is often used, can have very different properties, because the properties depend heavily on the source in each case. If the variety of wood properties within a range is ignored, this can lead to various problems with regard to screws breaking off.

At a width of 140 mm, Bangkirai woods or other hardwood/tropical woods can swell or shrink by up to 7 mm, depending on the wood moisture. With direct screwing through the boards into the substructure we recommend using a pair of screws. If the board is fastened directly on the substructure and the board works from the centre by about 3,5 mm, this leads in some cases to the screws being sheared off. The hardwood/tropical wood does not allow the screw to absorb any movement because it can barely be compressed because of its own high density.

Although deck/wood construction screws today have a suitable deflection angle, hardwoods that are placed directly on top of each other function as shearing modules that shear the screws off if the wood swells or shrinks. (Per board half = 3,5 mm displacement, this conforms to about the inside diameter of a screw with a 5 mm thread, which is the minimum that should be used with tropical woods).

In certain circumstances, screwing in the centre of the board might be deducted from this. Unfortunately, tropical woods have an extremely high internal stress, which leads to the boards twisting (dishing), which in most cases requires pairs of screws.

However, using a spacer (e.g. Dista-Leiste 2.0 or deck glider) between the substructure and deck board is very helpful here. This provides the screws with a possibility of bending in the direction of the working wood. The danger of shearing is greatly reduced. In addition, this clearance protects the wood from waterlogging at the support points. The ageing process is slowed down clearly.

A mistake that is frequently made is to have centre distances in the substructure that are too large. The most durable results are achieved if this clearance, and therefore the screw clearance in the lengthwise direction of the boards, is max. 60 cm.

**Please note that the installation information provided here is merely a recommendation and does not constitute binding assembly instructions. Every assembly job is subject to different performance requirements, e.g. locally applicable building regulations, and the tradesman carrying out the installation is responsible for compliance with these requirements.**



**Pilot-drilling is always better with problematic woods. These are above all hardwood/tropical woods, but also some coniferous woods that tend to crack easily, such as e.g. Douglas fir.**

**Pilot drilling prevents the wood splitting. With regard to the edge distances make sure that there is at least 6 cm clearance to the end of the board.**

(Please note: because of the high internal stress the boards can also crack open later at the ends and in the middle. This also applies to thermally treated woods).

# Overview of timber types\*

\*Solid wood decking is not part of our product range. This short overview represents a planning aid.

A timber deck matches any ambience. Whether they are left natural and greying or are treated with care products: They lend a certain proximity to nature or even a sense of urban chic, and always a sense of well-being.

As well as a suitable fastening system, above all good planning and professional assembly are essential for long-lasting, low-maintenance deck construction. Not all timber is the same: As well as aesthetics and price, it is advisable to weigh up the technological properties against one another. A timber with very high durability and an astoundingly beautiful exterior can, for example, have only moderate dimensional stability and may not be suited for indirect, hidden fastening. This overview of the most common deck timbers might assist you in your considerations.

Please ensure that you refer to the information we provide on "Hazards in the construction of timber decks" on page 17.



## Glossary

- E-modulus (modulus of elasticity) – resistance of a material to elastic deformation. The higher the Young's modulus, the stiffer the component. This overview quotes the Young's modulus as measured parallel to the grain.
- Durability class – indication of the natural durability of the heartwood with respect to fungus, from 1 (very durable) to 5 (not durable).
- Dimensional stability – characteristic of the timber not to warp, twist, etc. due to swelling/shrinkage.



## Thermo Pine (*Pinus sylvestris*)

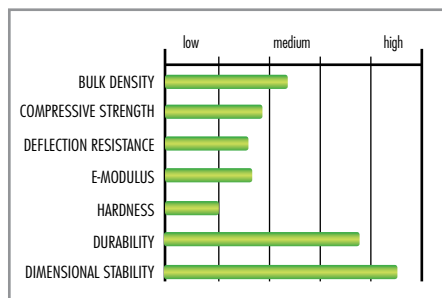

- + High durability
- + No resin leakage
- + Low swelling and shrinkage
- + Substitute for tropical timber
- + Excellent dimensional stability
- + Mostly obtained from sustainable forestry
- Surface made brittle by thermal treatment
- Not for structural applications
- Only moderate hardness

### General details:

- **Origin:** Europe, east as far as Siberia
- **Colour:** Uniform brown to dark brown as a result of thermal treatment, also greying as untreated timber
- **Durability class:** 1–3 with thermal treatment (3–4 untreated)
- **Properties:** Low swelling and shrinkage, excellent dimensional stability. Thermal treatment leads to a reduction in strength and elasticity, causing the surface to become brittle. Contrast-rich texture.

### Application:

Deck construction, sometimes as a substitute for tropical timber, not to be used for structural applications.

### Installation instructions:

- Centre distance in substructure: max. 50 cm
- Joint width between boards: 6 to 8 mm
- Spacing between butt joints: 3 to 4 mm

### Fastening recommendation:

Use Thermofix screw with drill point for the deck glider (brittle surface!). For direct fastening, use Terrasotec A4 5,5 mm, Hapatec Heli A4 5,0 mm or Profile drilling screw A4 5,5 mm for Eurotec aluminium profiles. It is always advisable to drill a pilot hole with a drill stop.

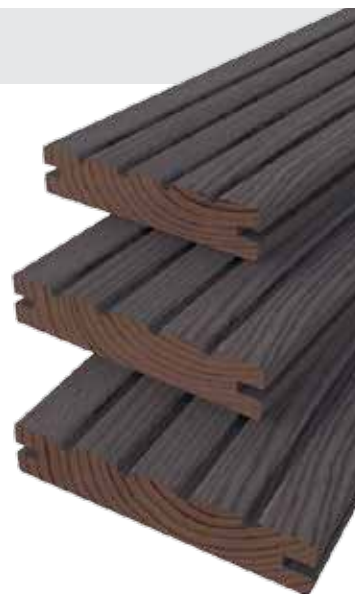

## Robinia, False Acacia (*Robinia pseudoacacia*)

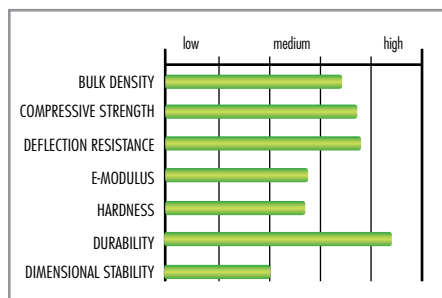

- + High durability
- + High strength
- + High hardness
- + Substitute for tropical timber
- + Largely sourced from sustainable forestry
- Moderate dimensional stability

### General details:

- **Origin:** North America, also cultivated in Europe since the 17th century (not to be confused with Acacia)
- **Colour:** Yellow-green to olive brown, darkening to golden brown
- **Durability class:** 1–2, most-durable domestic timber
- **Properties:** High swelling and shrinkage, satisfactory to moderate dimensional stability, high strength and hardness, distinctive texture.

### Application:

Deck construction, window frames, playground construction, fencing, excellent structural timber for outdoor use, sometimes used as a substitute for tropical timber.

### Installation instructions:

- Centre distance in substructure: max. 60 cm
- Joint width between the boards: 6 to 10 mm
- Spacing between the butt joints: 3 to 4 mm

### Fastening recommendation:

For timbers with high wood density and/or moderate dimensional stability, direct fastening of the boards is preferable to hidden. This applies above all to board thicknesses > 25 mm. For direct fastening, use Terrasotec A4 5,5 mm or Profile drilling screw A4 5,5 mm for Eurotec aluminium profiles. It is always advisable to drill a pilot hole with a drill stop.



## Merbau (*Intsia spp.*)

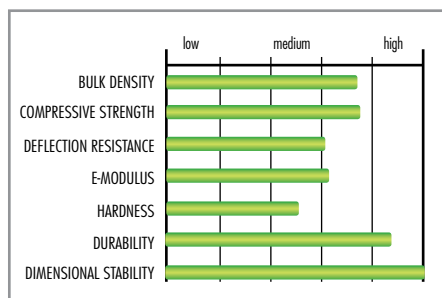

- + High durability
- + High strength
- + High hardness
- + Low swelling and shrinkage
- + Exceptionally good dimensional stability
- Possible erosion of constituent substances in the timber
- Originates almost exclusively from overexploitation (certified timber barely available)

### General details:

- **Origin:** Southeast Asia, trade name encompasses various species
- **Colour:** Light brown to reddish brown, darkening to brown to dark copper brown
- **Durability class:** 1–2
- **Properties:** Very low swelling and shrinkage, excellent dimensional stability, high strength and hardness

### Application:

Deck construction, window frames, parquet, stairs, furniture

### Installation instructions:

- Centre distance in substructure: max. 60 cm
- Joint width between the boards: 4 to 6 mm
- Spacing between the butt joints: 3 to 4 mm

### Fastening recommendation:

For direct fastening, use Terrasotec A4 5,5 mm or Profile drilling screw A4 5,5 mm for Eurotec aluminium profiles. It is always advisable to drill a pilot hole with a drill stop.



## Massaranduba (*Manilkara spp.*)

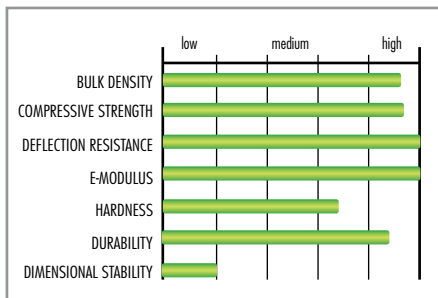

- + High durability
- + Extremely high strength
- + High hardness
- Extremely low dimensional stability
- Often originates from overexploitation (use only certified timber wherever possible)
- We consider permanent, secure fastening to be highly critical

### General details:

- **Origin:** Northern to central South America, trade name encompasses various species
- **Colour:** Meaty red colour, later darkening to dark brown
- **Durability class:** 1-2
- **Properties:** High swelling and shrinkage, satisfactory to moderate dimensional stability, extremely high strength, high hardness, homogeneous texture.

### Application:

Deck construction, floors subject to heavy loads, noise barriers and privacy screens, fencing, structural timber, sometimes used in water engineering.

### Installation instructions:

The installation is extremely dependent on the timber's moisture level. The wood moisture must always be determined before installation. Ask your timber supplier for more information.

### Fastening recommendation:

For timbers with high wood density and/or moderate dimensional stability, direct fastening of the boards is preferable to indirect. This applies above all to board thicknesses > 25 mm. For direct fastening, use Terrasotec A4 5,5 mm in combination with the Dista-Leiste 2.0 or profile drilling screw A4 5,5 mm for Eurotec aluminium profiles. It is always advisable to drill a pilot hole with a drill stop. Nevertheless, we cannot provide a general recommendation, as damage is repeatedly found to occur with this type of timber.



## Kapur (*Dryobalanops spp.*)

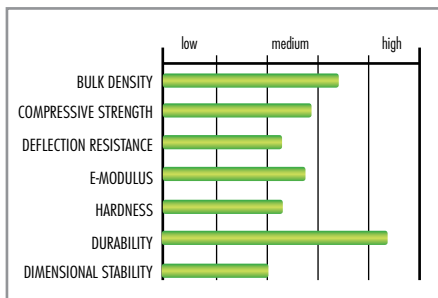

- + High durability
- Possible erosion of constituent substances in the timber
- Often originates from overexploitation (use only certified timber wherever possible)
- Moderate hardness
- Moderate dimensional stability

### General details:

- **Origin:** Southeast Asia, trade name encompasses various species
- **Colour:** Orange to reddish brown, darkening to brown
- **Durability class:** 1-2
- **Properties:** Moderate to high swelling and shrinkage, satisfactory to moderate dimensional stability, homogeneous texture.

### Application:

Deck construction, fencing, structural timber

### Installation instructions:

- Centre distance in substructure: max. 60 cm
- Joint width between the boards: 6 to 10 mm
- Spacing between the butt joints: 3 to 4 mm

### Fastening recommendation:

For timbers with high wood density and/or moderate dimensional stability, direct fastening of the boards is preferable to hidden. This applies above all to board thicknesses > 25 mm. For direct fastening, use Terrasotec A4 5,5 mm or Profile drilling screw A4 5,5 mm for Eurotec aluminium profiles. It is always advisable to drill a pilot hole with a drill stop.



## Ipé, Lapacho (*Tabebuia spp.*)

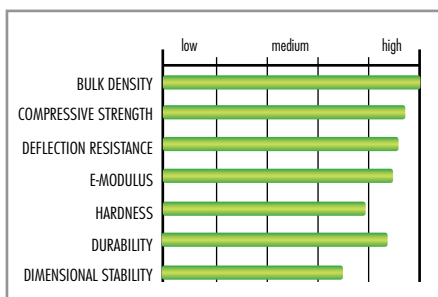

- + High durability
- + Good dimensional stability
- + Extremely high strength
- + Very high hardness
- + Approved structural timber
- Often originates from overexploitation (use only certified timber wherever possible)

### General details:

- **Origin:** Northern to central South America, trade name encompasses various species
- **Colour:** Light brown to light yellowish brown, later darkening to brown to olive brown
- **Durability class:** 1-2
- **Properties:** Moderate to high swelling and shrinkage, good dimensional stability, extremely high strength, very high hardness, homogeneous texture.

### Application:

Deck construction, bridge construction and shipbuilding, floating jetties, fencing, parquet, floors subject to heavy loads, approved structural timber, sometimes used in water engineering.

### Installation instructions:

- Centre distance in substructure: max. 60 cm
- Joint width between the boards: 6 to 8 mm
- Spacing between the butt joints: 3 to 4 mm

### Fastening recommendation:

For timbers with high wood density and/or moderate dimensional stability, direct fastening of the boards is preferable to hidden. This applies above all to board thicknesses > 25 mm. For direct fastening: Terrasotec, hardened stainless steel, 5,0 and 5,5 mm; Hapatec, hardened stainless steel, 5,0 mm; or Profile drilling screw, hardened stainless steel, 5,5 mm for Eurotec aluminium profiles. It is always advisable to drill a pilot hole with a drill stop.





## Garapa (*Apuleia spp.*)

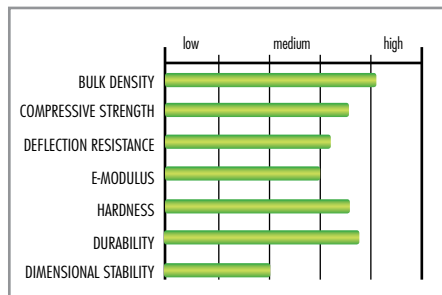

- + High durability (variable)
- + High strength
- + Very high hardness
- Possible erosion of constituent substances in the timber
- Often originates from overexploitation (use only certified timber wherever possible)
- Moderate dimensional stability

### General details:

- **Origin:** South America, trade name encompasses various species
- **Colour:** Honey yellow, later darkening to yellowish brown or golden brown
- **Durability class:** Varies between 1 and 3
- **Properties:** Moderate to high swelling and shrinkage, satisfactory to moderate dimensional stability, plain, homogeneous texture.

### Application:

Deck construction, furniture, window frames

### Installation instructions:

- Centre distance in substructure: max. 60 cm
- Joint width between the boards: 6 to 10 mm
- Spacing between the butt joints: 3 to 4 mm

### Fastening recommendation:

For timbers with high wood density and/or moderate dimensional stability, direct fastening of the boards is preferable to hidden. This applies above all to board thicknesses > 25 mm.

For direct fastening, use Terrasotec A4 5,5 mm or Profile drilling screw A4 5,5 mm for Eurotec aluminium profiles.

It is always advisable to drill a pilot hole with a drill stop.



## Douglas Fir (*Pseudotsuga menziesii*)

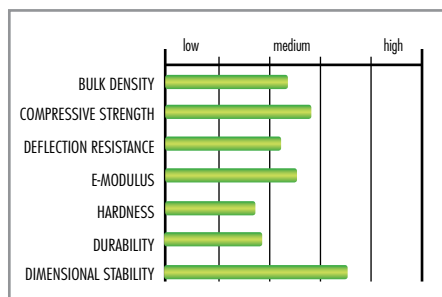

- + Low swelling and shrinkage
- + Good dimensional stability
- + Approved structural timber
- + Substitute for tropical timber
- + Largely sourced from sustainable forestry
- Resin bleed possible
- Moderate durability but sufficient for deck construction
- Moderate hardness

### General details:

- **Origin:** North America, also cultivated in Europe since the 19th century
- **Colour:** Light yellowish brown to red brown, resembles European Larch.
- **Durability class:** 3-4
- **Properties:** High elasticity, low swelling and shrinkage, good dimensional stability, low resin content, fine texture.

### Application:

Deck construction, façades, solid-wood floorboards, window frames, fencing, approved structural timber, sometimes used as a substitute for tropical timber.

### Installation instructions:

- Centre distance in substructure: max. 60 cm
- Joint width between the boards: 6 to 8 mm
- Spacing between the butt joints: 3 to 4 mm

### Fastening recommendation:

For direct fastening: Terrasotec, hardened stainless steel, 5,0 and 5,5 mm; Hapatec, hardened stainless steel, 5,0 mm; or Profile drilling screw, hardened stainless steel, 5,5 mm for Eurotec aluminium profiles.

It is always advisable to drill a pilot hole with a drill stop (risk of splintering).



## Cumarú (*Dipteryx spp.*)

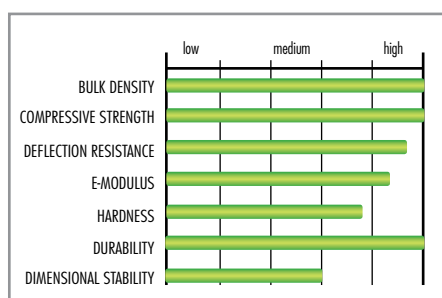

- + Very high durability
- + Extremely high strength
- + Very high hardness
- Possible erosion of constituent substances in the timber
- Often originates from overexploitation (use only certified timber wherever possible)
- Moderate dimensional stability

### General details:

- **Origin:** Northern South America, trade name encompasses various species
- **Colour:** From yellowish to red to violet brown, later darkening to yellowish brown to olive brown
- **Durability class:** 1
- **Properties:** High swelling and shrinkage, good to satisfactory dimensional stability, extremely high strength, very high hardness, homogeneous texture.

### Application:

Deck construction, floors subject to heavy loads, structural timber, sometimes used in water engineering.

### Installation instructions:

- Centre distance in substructure: max. 60 cm
- Joint width between the boards: 6 to 8 mm
- Spacing between the butt joints: 3 to 4 mm

### Fastening recommendation:

For timbers with high wood density and/or moderate dimensional stability, direct fastening of the boards is preferable to hidden. This applies above all to board thicknesses > 25 mm.

For direct fastening: Terrasotec A2 5,5 mm or Profile drilling screw A4 5,5 mm for Eurotec aluminium profiles.

It is always advisable to drill a pilot hole with a drill stop.



## Bangkirai, Yellow Balau (*Shorea spp.*)

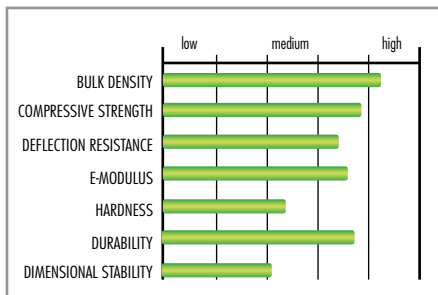

- + High durability
- + High strength
- + High hardness

- Possible erosion of constituent substances in the timber
- Often originates from overexploitation (use only certified timber wherever possible)

### General details:

- **Origin:** South, Southeast and East Asia, trade name encompasses various species
- **Colour:** Yellowish brown, often darkening to olive brown
- **Durability class:** 2
- **Properties:** Medium to high swelling and shrinkage, satisfactory dimensional stability, high strength and hardness, distinctive texture.

### Application:

Deck construction, piers, floating jetties, fencing, stables, flooring subject to heavy use, structural timber in water engineering. Many of the Shorea species of the Meranti group are used for window frames.

### Installation instructions:

Installation is extremely dependent on the timber's moisture level. The wood moisture must always be determined before installation. Ask your timber supplier for more information.

### Fastening recommendation:

For timbers with high wood density and/or moderate dimensional stability, direct fastening of the boards is preferable to hidden. This applies above all to board thicknesses > 25 mm. For direct fastening: Terrasotec, hardened stainless steel, 5,0 and 5,5 mm; Hapatec, hardened stainless steel, 5,0 mm; or Profile drilling screw, hardened stainless steel, 5,5 mm for Eurotec aluminium profiles. It is always advisable to drill a pilot hole with a drill stop.



## Oak (*Quercus robur, Quercus petraea*)

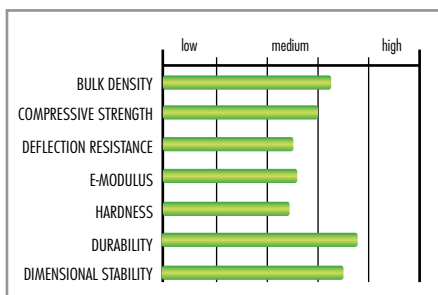

- + High durability
- + Good dimensional stability
- + High hardness
- + Approved structural timber
- + Substitute for tropical timber
- + Largely sourced from sustainable forestry

### General details:

- **Origin:** Europe
- **Colour:** Yellow brown, darkening to brown to olive brown
- **Durability class:** 2
- **Properties:** Low swelling and shrinkage, good dimensional stability; distinctive, decorative texture.

### Application:

Deck construction, stairs, parquet, furniture, window frames, fencing, approved structural timber, sometimes used as a substitute for tropical timber.

### Installation instructions:

- Centre distance in substructure: max. 60 cm
- Joint width between the boards: 6 to 8 mm
- Spacing between the butt joints: 3 to 4 mm

### Fastening recommendation:

For direct fastening, use Terrasotec A4 5,5 mm or Profile drilling screw A4 5,5 mm for Eurotec aluminium profiles. It is always advisable to drill a pilot hole with a drill stop.



## Walaba (*Eperua spp.*)

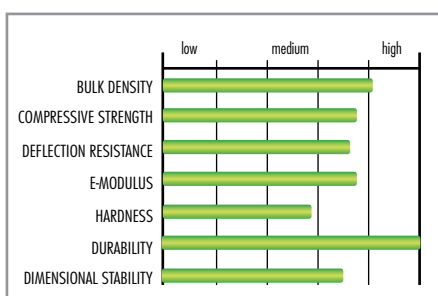

- + Very high durability
- + No erosion
- + Low swelling and shrinkage
- + Good dimensional stability
- + High strength and hardness
- + Timber from reservoirs means no destruction of primeval forest

### General details:

- **Origin:** As reservoir timber from the Brokopondo Reservoir in Suriname (South America), otherwise from northern South America; trade name encompasses various species.
- **Colour:** Red brown to dark brown
- **Durability class:** 1
- **Properties:** As reservoir timber: low swelling and shrinkage, good dimensional stability, high strength and hardness, very decorative.

### Application:

Deck construction, water engineering, fencing, piles, masts, structural timber.

### Installation instructions:

- Centre distance in substructure: max. 60 cm
- Joint width between the boards: 6 to 8 mm
- Spacing between the butt joints: 3 to 4 mm

### Fastening recommendation:

For direct fastening, use Terrasotec A4 5,5 mm or Profile drilling screw A4 5,5 mm for Eurotec aluminium profiles. It is always advisable to drill a pilot hole with a drill stop.





## Siberian Larch (*Larix sibirica*)

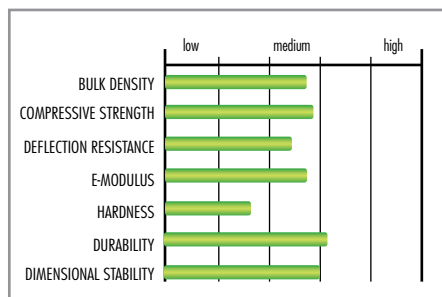

- + Low swelling and shrinkage
- + Predominantly knot-free
- + Approved structural timber
- Resin bleed possible
- Often originates from overexploitation, so questionable as a substitute for tropical timber (use only certified timber wherever possible)
- Moderate hardness

### General details:

- Origin: Western and Southern Siberia, Mongolia
- Colour: Yellowish (European Larch: yellowish to reddish-brown)
- Durability class: Varies from 1 to 4 depending on where it is grown
- Properties: Very narrow rings, giving it a high wood density for softwood, high elasticity, low swelling and shrinkage, good to satisfactory dimensional stability, predominantly knot-free, low resin content, straight-grained texture.

### Application:

Deck construction, façades, solid-wood floorboards, window frames, fencing, approved structural timber.

### Installation instructions:

- Centre distance in substructure: max. 60 cm
- Joint width between the boards: 6 to 8 mm
- Spacing between the butt joints: 3 to 4 mm

### Fastening recommendation:

For direct fastening: Terrasotec, hardened stainless steel, 5,0 and 5,5 mm; Hapotec, hardened stainless steel, 5,0 mm; or Profile drilling screw, hardened stainless steel, 5,5 mm for Eurotec aluminium profiles.  
Pilot-drilling with drill stop recommended.



## Thermo Ash (*Fraxinus spp.*)

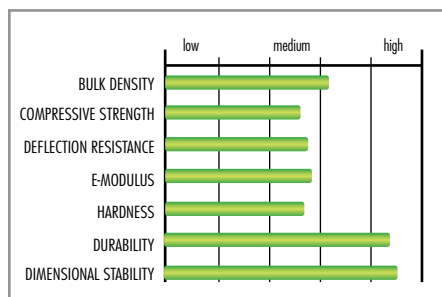

- + High durability
- + No erosion
- + Low swelling and shrinkage
- + Very good dimensional stability
- + Substitute for tropical timber
- + Largely sourced from sustainable forestry
- Surface made brittle by thermal treatment
- Not for structural applications
- Moderate hardness

### General details:

- Origin: Central and Eastern Europe, North America
- Colour: Dark brown; also greying as untreated timber
- Durability class: 1-2; untreated: 5
- Properties: Low swelling and shrinkage, excellent dimensional stability, thermal treatment leads to reduction in strength and elasticity and causes the surface to become brittle.

### Application:

Deck construction, parquet, floors, garden furniture, sometimes as a substitute for tropical timber, not to be used for structural applications.

### Installation instructions:

- Centre distance in substructure: max. 50 cm
- Joint width between the boards: 4 to 6 mm
- Spacing between the butt joints: 3 to 4 mm

### Fastening recommendation:

Use Thermofix screw with drill point for the deck glider (brittle surface!).  
For direct fastening, use Terrasotec A4 5,5 mm or Profile drilling screw A4 5,5 mm for Eurotec aluminium profiles.  
It is always advisable to drill a pilot hole with a drill stop.

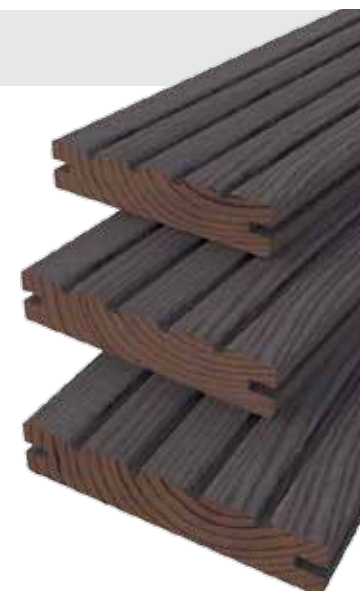

## Thermo-Beech (*Fagus sylvatica*)

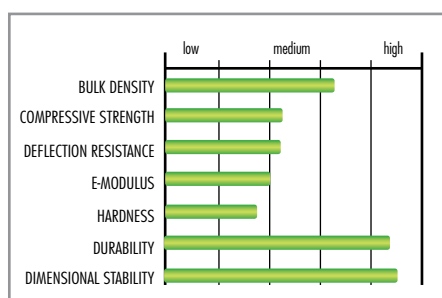

- + High durability
- + No erosion
- + Low swelling and shrinkage
- + Very good dimensional stability
- + Substitute for tropical timber
- + Largely sourced from sustainable forestry
- Surface made brittle by thermal treatment
- Not for structural applications
- Moderate hardness

### General details:

- Origin: Central and South-Eastern Europe
- Colour: Dark brown; also greying as untreated timber
- Durability class: 1-2; untreated: 5
- Properties: Low swelling and shrinkage, excellent dimensional stability, thermal treatment causes reduction in strength and elasticity and makes the surface brittle, plain texture.

### Application:

Deck construction, parquet, floors, worktops, sometimes as a substitute for tropical timber, not to be used for structural applications.

### Installation instructions:

- Centre distance in substructure: max. 40 cm
- Joint width between the boards: 6 to 8 mm
- Spacing between the butt joints: 3 to 4 mm

### Fastening recommendation:

Use Thermofix screw with drill point for the deck glider (brittle surface!).  
For direct fastening, use Terrasotec A4 5,5 mm or Profile drilling screw A4 5,5 mm for Eurotec aluminium profiles.  
It is always advisable to drill a pilot hole with a drill stop.



## Courbaril, Jatobá (*Hymenea spp.*)

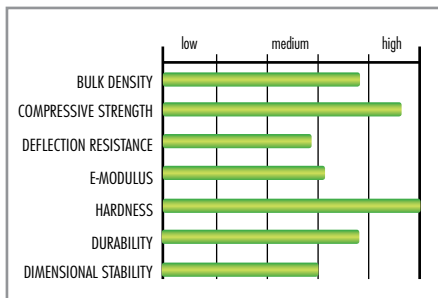

- + High durability
- + No washing out
- + Extremely high strength
- + Extremely high hardness

- Only moderate dimensional stability
- Often originates from overexploitation (use only certified timber wherever possible)

### General details:

- **Origin:** Central and South America
- **Colour:** Trade name encompasses various species, usually salmon-coloured to yellowish brown, often later darkening to orange-brown to copper-coloured.
- **Durability class:** 1-3
- **Properties:** High swelling and shrinkage, good to satisfactory dimensional stability, high strength, extremely high hardness, very decorative.

### Application:

Deck construction, solid wood floorboards, heavy-duty flooring, furniture, structural timber.

### Installation instructions:

- Centre distance in substructure: max. 60 cm
- Joint width between boards: 6 to 8 mm
- Spacing between butt joints: 3 to 4 mm

### Fastening recommendation:

For timbers with high wood density and/or moderate dimensional stability, direct fastening of the boards is preferable to indirect. This particularly applies to board thicknesses > 25 mm.  
For direct fastening, use Terrasotec A4 5,5 mm, Hapatec Heli A4 5,0 mm or Profile drilling screw A4 5,5 mm for Eurotec aluminium profiles. It is always advisable to drill a pilot hole with a drill stop.



## Acetylated wood (*Various types of timber*)

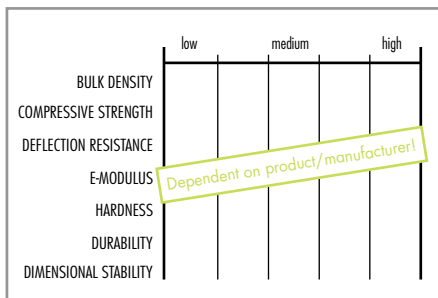

- + High durability
- + Very low swelling and shrinkage
- + Exceptionally good dimensional stability
- + Substitute for tropical timber
- + Mostly obtained from sustainable forestry

- Surface brittleness due to modification
- Not for structural applications
- Only moderate hardness

### General details:

- **Origin:** Various countries of origin
- **Colour:** Depending on type of timber used
- **Durability class:** 1 (3-4 untreated)
- **Properties:** Very low swelling and shrinkage, exceptionally good dimensional stability. Possible brittleness due to modification with resulting increase in hardness and reduction of the timber's equilibrium moisture content.

### Application:

Deck construction, façades, window frames, sometimes as a substitute for tropical timber, not to be used for structural applications.

### Installation instructions:

- Centre distance in substructure: max. 60 cm
- Joint width between boards: 4 to 6 mm
- Spacing between butt joints: 3 to 4 mm

### Fastening recommendation:

Use Thermofix screw with drill point for the deck glider (brittle surface).  
For direct fastening, use Terrasotec A4 5,5 mm, Hapatec Heli A4 5,0 mm or Profile drilling screw A4 5,5 mm for Eurotec aluminium profiles.  
It is always advisable to drill a pilot hole with a drill stop.



## WPC (*Wood-Plastic-Composite*)

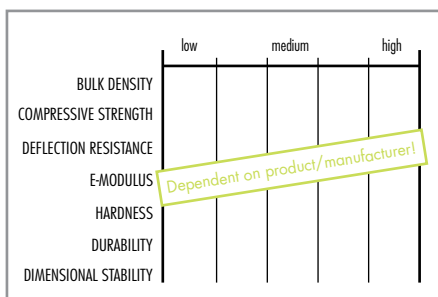

- + Good dimensional stability
- + Barefoot board
- + No erosion
- + Substitute for tropical timber
- + Largely sourced from sustainable forestry

### General details:

Depending on the product in question, wood-plastic composite materials consist of different proportions of wood, plastics and additives. The wood content varies from 50% to 70%.  
The natural fibres incorporated into the material originate predominantly from sustainable forestry. The properties of these polymer-bound products are equivalent to those of high-quality timber-based materials.

### Application:

Deck construction, fencing, garden furniture, façades, edge profiles, privacy screen elements, sometimes used as a substitute for tropical timber.

### Installation instructions:

Substructure spacing and joint width according to manufacturer's information.

### Fastening recommendation:

WPC boards are usually fastened hidden and invisibly with clips, e.g. T-Stick on aluminium substructure.

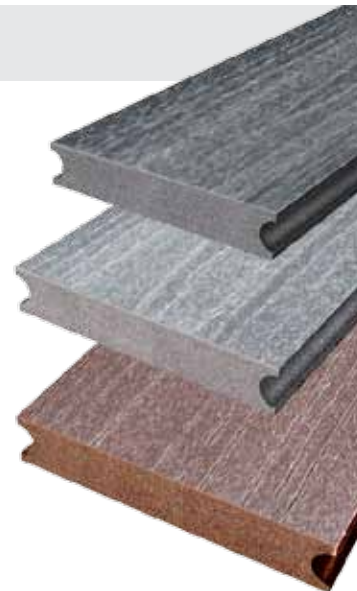

\*Solid wood decking is not part of our product range. This short overview represents a planning aid.







# We are happy to advise you on your construction projects

Contact our technical department or use the free calculation software in the service area on our homepage:

[www.eurotec.team](http://www.eurotec.team)



## Calculations/planning in the terrace area

- Quantity surveys and product recommendations for the construction of terraces
- Planning of special terraces, e.g. elevated terraces
- Installation diagram of terraces if necessary after placing an order
- Customised product developments for terrace construction

## Calculations/planning in the field of timber construction

- On-rafter insulation with Paneltwistec and Topduo
- Main/secondary Beam connections with KonstruX, Atlas, Magnus and IdeeFix
- Geometric/joist doubling panels with KonstruX, Paneltwistec and Topduo
- Support reinforcements with KonstruX
- Rafter/purlin joints with KonstruX, Paneltwistec and Topduo

## Calculations/planning in the area of concrete

- Fasteners in/on concrete components with rock concrete screw, bolt anchor and injection anchor

## Calculations/planning in the façade area

- Quantity determinations for fixing facades and façade elements with EiSYS façade screws, Klimax insulation dowels, ERD frame dowels, Topduo and Paneltwistec

All data are planning/design aids and if necessary should be checked by a specialist planner!

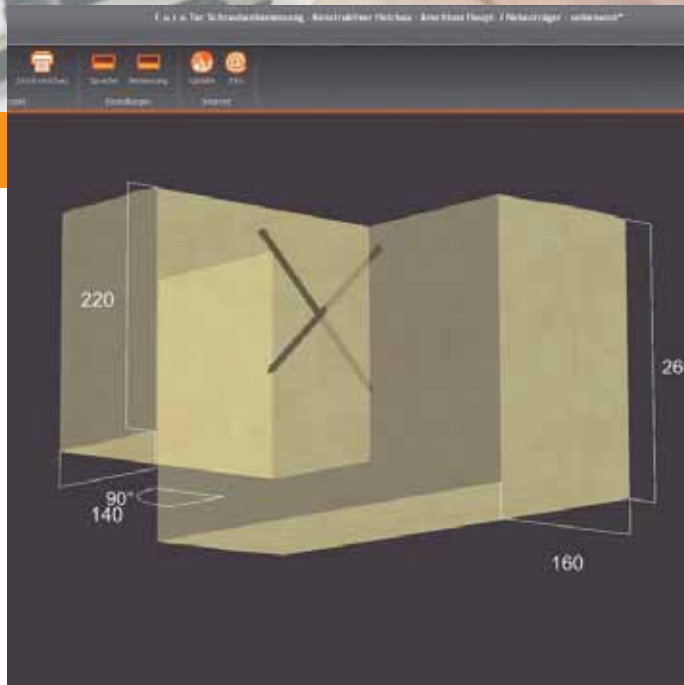

Your contact person can be reached by  
**E-Mail: [technik@eurotec.team](mailto:technik@eurotec.team)**  
**Tel: 02331 - 62 45-444**



by phone 02331 6245-444 · by fax 02331 6245-200 · by e-mail [technik@eurotec.team](mailto:technik@eurotec.team)

Please contact our technical department or use the free [calculation services](#) in the service section of our website.

Contact

Trader:	_____	Contractor:	_____
Contact person:	_____	Contact person:	_____
e-mail:	_____	Phone:	_____
Project:	_____	e-mail:	_____

Project details

Utilisation

(to determine the loading capacity)

- |   |   |                                 |
|---|---|---------------------------------|
| <input type="checkbox"/> private<br>(close to ground level) | <input type="checkbox"/> private<br>(Roof terraces, balconies, loggias) | <input type="checkbox"/> public |
| <input type="checkbox"/> Visible fastening                  | <input type="checkbox"/> Hidden fastening                               |                                 |

Length Side A: \_\_\_\_\_ m  
(running in direction of the substructure)

Length Side B: \_\_\_\_\_ m  
(running in direction of the boards)

Centre distance e: \_\_\_\_\_ m  
(substructure spacing)

Total assembly height from \_\_\_\_\_ to \_\_\_\_\_ mm  
(Top edge of ground/finished floor/roof ↔ Top edge of board)

Nivello 2.0 required:  Yes  No  
(to compensate a sloped subsurface)

Dimensions of decking boards: \_\_\_\_\_ mm  
(Strength x width)

Boards grooved:  Yes  No  
(if yes, please enclose a sketch showing groove)

Type of wood: \_\_\_\_\_

Timber substructure

Dimensions of joist: \_\_\_\_\_ mm  
(Length x width)

Timber type of joist: \_\_\_\_\_

Deck edging end profile:  Yes  No

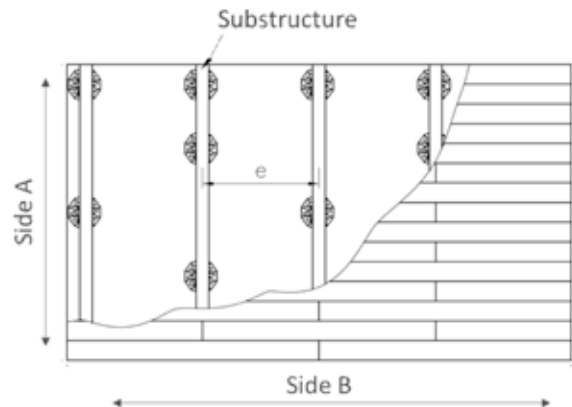

- |   |  |
|---|--|
| <input type="checkbox"/> System profile EVO Light<br>34 x 32 x 4000 mm<br>W x H x L | <input type="checkbox"/> Support profile HKP<br>60 x 100 x 4000 mm<br>W x H x L    |
| <input type="checkbox"/> System profile EVO<br>60 x 40 x 4000 mm<br>W x H x L       | <input type="checkbox"/> System profile EVO Slim<br>60 x 20 x 4000 mm<br>W x H x L |

\*e.g. in connection with Systemclip ECO

by phone 02331 6245-444 · by fax 02331 6245-200 · by e-mail technik@eurotec.team

Please contact our technical department or use the free calculation services in the service section of our website.

Contact

Trader: \_\_\_\_\_

Contractor: \_\_\_\_\_

Contact person: \_\_\_\_\_

Contact person: \_\_\_\_\_

e-mail: \_\_\_\_\_

Phone: \_\_\_\_\_

Project: \_\_\_\_\_

e-mail: \_\_\_\_\_

Project details

Utilisation

(to determine the loading capacity)

- private (close to ground level)
- private (Roof terraces, balconies, loggias)
- public
- Corner support system (mounted on adjustable pedestals)
- Stone-System (mounted on aluminium profiles)

Length Side A: \_\_\_\_\_ m  
(in stress direction of substructure = SS)

Length Side B: \_\_\_\_\_ m

Centre distance e: \_\_\_\_\_ m  
(SS spacing)

Total assembly height from \_\_\_\_\_ to \_\_\_\_\_ mm  
(Top edge of ground/finished floor/roof ↔ Top edge of board)

Nivello 2.0 required:  Yes  No  
(to compensate a sloped subsurface)

Flooring dimensions\*: \_\_\_\_\_ mm  
(dimension A x dimension B x slab thickness)

\* Refer to manufacturer's information on mounting stone slabs! Using our system does not exempt planners/installers from the need to inform themselves of the manufacturer's specifications for other products (installed in conjunction with our system).

Deck edging end profile:  Yes  No

Substructure with aluminium profile



System profile EVO  
60 x 40 x 4000 mm  
W x H x L

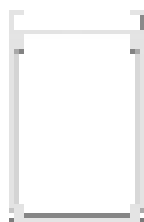

System profile EVO Slim  
60 x 20 x 4000 mm  
W x H x L

Support profile HKP  
60 x 100 x 4000 mm  
W x H x L

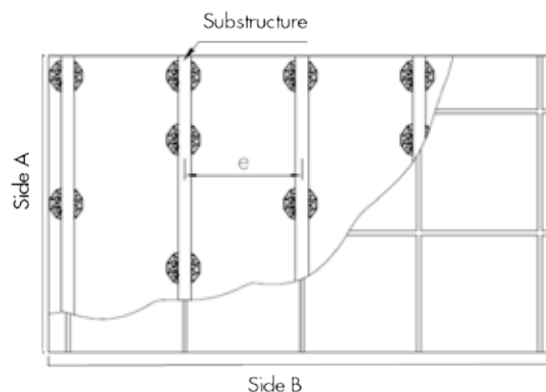

Cross bond

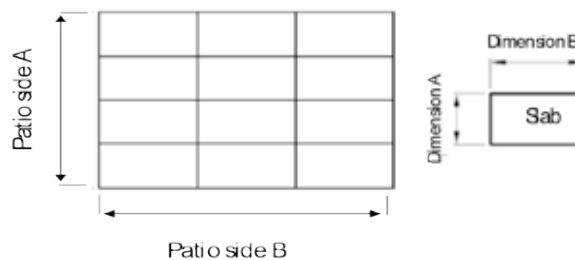

Stretcher bond

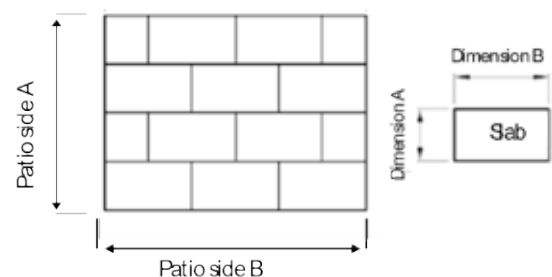







Available soon

# Our NEW terrace software

The cutting-edge software to facilitate material requirements planning for terrace construction now, in addition to a **general design update**, features not only a super **user-friendly interface**, but also a host of new features. These include, in addition to the industry-standard basics, **gradient and discharge planning**, **sketches** as well as **detailed product dependencies**, so that you always have the **best results for your material requirements planning**.\*



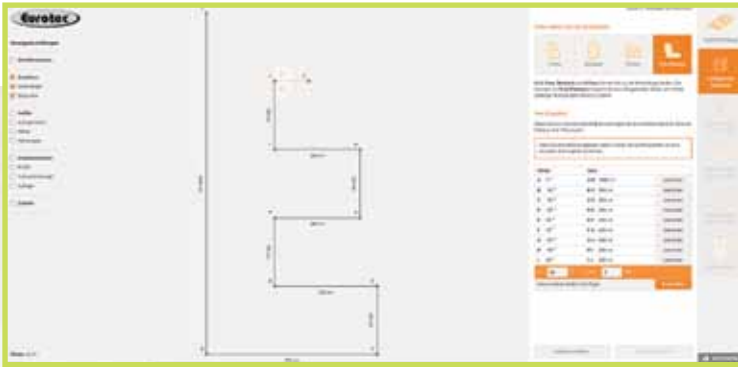

### Individual designs with free planning

When selecting your basic shape, you can not only pick from the terrace geometries that are already available. You also have the option to map more complex geometries with the help of free planning.



### Heights, gradients and drains

The terrace software makes it easy to plan the elevation level of your building project. The elevation data is displayed systematically for each adjustable foot. Even gradients do not pose a problem for terrace planning, thanks to the customisable height points.



### Planning result\*

Get the best planning result for material requirements planning for your project specifications, including a downloadable PDF and the option to send your project directly as an email.



### Save the code and continue later!

During the planning process, you can save your project as a link with the save function and continue working on it at a later stage.

\* For the calculation, assumptions were made on the basis of the information you provided. Check the assumptions made. The specified values, type and number of fasteners are planning aids as offered. Volumes may deviate during implementation planning.



# Deck substructure

Essential for a perfect deck

High-grade solutions for all types  
of substructure

Without a perfect substructure, your deck will soon become defective. We offer a number of aids that let your deck remain attractive for a long time.

We will show you what's important!



# Cork accessories for decking substructures

## Cork, what is it?

Cork is a natural product obtained from the bark of the cork oak. The cork oak is a deciduous tree that is native primarily to the western Mediterranean, e.g. Spain and Portugal. To harvest the cork, the bark is peeled directly off the tree by hand.

As cork is a renewable natural product, a tree can be reharvested approx. every 10 years without causing damage to the tree.

A cork oak has a life expectancy of up to 300 years and delivers approx. 100 to 200 kilograms of cork over its lifespan.

**Free of PAHs**  
(hazardous plasticisers in rubber).

### Properties and advantages

- Water-repellent (hydrophobic) and moisture-resistant
- Chemically neutral – free of PAHs (PAHs are toxic, carcinogenic plasticisers that are found primarily in rubber compounds)
- Does not decompose and is resistant to most acids and lye
- Dampens footfall sound, is non-slip and insulates against heat, noise and vibrations
- Resistant to rot, bacteria and germs
- Very pressure-stable and exhibits hardly any expansion
- Flame-resistant (fire class B2)

**Cork is a sustainable, environmentally friendly natural product.**



The cork pad spacers are laid between the deck substructure and the foundation/subsurface (self-adhesive on one side) and thus form a gap that aids constructive timber protection. The cork pad spacers are available in three sizes. These are 3 mm, 6 mm and 10 mm thickness/height (see Fig.). In addition to the advantages already mentioned, useful side effects of using the spacer include the option to adjust the height of the substructure and that the loads are distributed evenly.

## Cork pad spacer

Self-adhesive



Art. no.	Dimensions [mm] <sup>a)</sup>	Material	PU
100348	60 x 60 x 3	Cork	25
100349	60 x 60 x 6	Cork	25
100350	60 x 60 x 10	Cork	25

<sup>a)</sup> Length x width x height

## Roof-protection cork

The natural underlay for adjustable pedestals



Art. no.	Dimensions [mm] <sup>a)</sup>	Material	PU
100355	200 x 200 x 3	Cork	10

<sup>a)</sup> Length x width x height

Using adjustable deck pedestals on, for example, PVC sheet roofs can lead to problems because of the plasticisers contained in the roofing. The roof-protection cork provides natural protection against mechanical damage to the roof sheeting, at the same time as preventing contact between the two materials. Free of PAHs (hazardous plasticisers in rubber).

# Accessories for decking substructures

## Root control fleece underlay

Permeable polypropylene underlay.  
Very limited permeability to water.  
Inhibits plant growth under the fleece.



Art. no.	Dimensions [m]	Material	PU
944799	1,6 x 10,0	Polypropylene 50g/m <sup>2</sup>	1

## Rolfi, spacers

These spacers form a gap between the substructure and the foundation/support and thus help to protect the wood of the boarding beams.

### Advantages

- Height adjustment of the substructure possible
- Even load distribution, minor irregularities are balanced out
- Dampens footfall noise

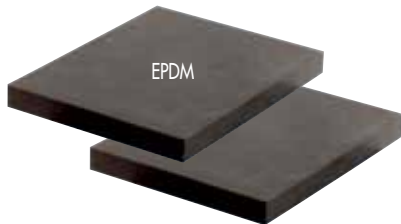

Art. no.	Dimensions [mm] <sup>a)</sup>	Material	PU
945966	3 x 60 x 60	EPDM, black	25
945967	6 x 60 x 60	EPDM, black	25
945379	10 x 60 x 60	EPDM, black	25

<sup>a)</sup> Height x length x width

## Protectus, timber-protection tape

The Protectus timber-protection tape provides lasting protection for your timber substructure from moisture, e.g. rain.

### Advantages

- Constructive timber protection
- Easy fastening thanks to adhesive film
- Optimum fit thanks to very thin material
- Tear-proof and durable
- Screws can be screwed through easily
- Can be individually cut to length



Art. no.	Dimensions [mm] <sup>a)</sup>	PU
946157	0,5 x 20000 x 75	1

<sup>a)</sup> Height x length x width



## Rolfi roll

The Rolfi roll forms a gap between the deck substructure and foundation/subsurface.

### Advantages

- Constructive timber protection
- Substructure height can be adjusted
- Uniform load distribution
- Small irregularities can be evened out
- Dampens footfall noise
- Can be individually cut to length



Art. no.	Dimensions [mm] <sup>01</sup>	Material	PU
945561	8 x 2015 x 70	Granulated rubber	10

<sup>01</sup> Height x length x width



# Eurotec Stone System

Building patios has never been so easy!

## Multifunctional installation system

Numerous possibilities! Suitable for all common deck coverings.

The multifunctional installation system Stone System from Eurotec minimises the effort involved in constructing a patio. One unique practical feature of this system is that it can be combined with various deck coverings. You simply need a load-bearing foundation, the Stone System from Eurotec, and the desired deck covering.

## Advantages

- Exceptionally economical
- Time-saving and straightforward installation
- Stone slabs can be combined with timber or WPC boards, for example
- Precise joint pattern
- Long-lasting
- Certified, high load-bearing capacity



For more information about the Stone system, please watch the application video on our YouTube channel

or download the Stone System brochure:  
[www.eurotec.team/en/catalogues](http://www.eurotec.team/en/catalogues)







## A perfectly constructed dream deck in just 8 steps

**1** Selection of materials/quantity determination

**2** Prepare foundation

**3** Install PRO adjustable pedestals

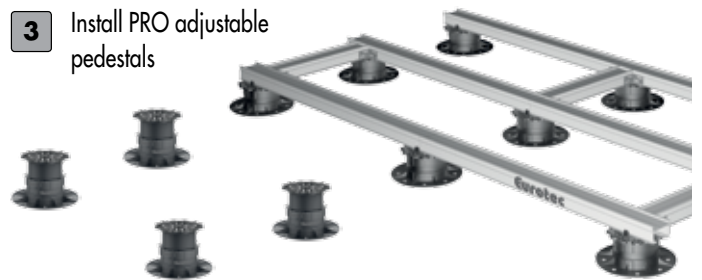

**4** Click EVO aluminium system profile onto adjustable pedestals and extend with EVO aluminium system profile connector so that the entire deck width is covered



**5** Using EVO corner connectors, attach cross braces to provide transverse stiffening in substructure



**6** Click the stone edge clips (at the edges) and the stone clips (within the paving) onto the EVO aluminium system profile



**7** Insert first stone slab and check spacings

**8** Align the substructure - uncomplicated and precise by means of variable adjustable pedestals - insert remaining stone slabs, done!



# Overview of Eurotec adjustable pedestals

## Properties/advantages

- High load-bearing capacity of up to 8 kN/pedestal
- Quick and easy assembly
- Stepless height adjustment
- Resistant to weather, UV exposure, insects and rot

## BASE adjustable pedestals

- Suitable for substructures made of aluminium and timber
- Four different sizes available
- Can be combined with the BASE adapter L, 32, 40 and 60
- Assembly heights of 25 - 210 mm
- Load-bearing capacity of 2,2 kN/pedestal

## Adjustable pedestal SL BASE

- Continuous self-adjusting of up to 7 %
- Suitable for substructures made of aluminium and timber
- Four different sizes available
- Can be combined with SL BASE-L-adapter, 40 and 60
- Assembly heights of 32 - 217 mm
- Load-bearing capacity of 2,2 kN/pedestal



**NEW**  
to our product range



## Profi-Line adjustable pedestals

- Versatile applications thanks to a modular system comprising four base pedestals of different heights, two rings for increasing the height, and four adapters:
  - **L adapter** for substructures made of aluminium and timber
  - **Click adapter 40** for Eveco aluminium system profile
  - **Click adapter 60** for EVO/EVO Slim aluminium system profile and HKP deck-support profile
  - **Stone adapter** for laying floor slabs
- Basic assembly heights of 10 - 168 mm
- Additional heights possible with the extension rings and extension plate
- High load-bearing capacity of up to 8,0 kN/pedestal

## SL PRO adjustable pedestals

- Self-levelling
- UV stability
- High fatigue strength
- Stepless height adjustment from 55 to 102 mm
- Can be combined with the L adapter
- Can be combined with the +4 and +10 extension rings
- Excellent chemical resistance
- Acoustic damping properties
- High load-bearing capacity of up to 8,0 kN/pedestal



# BASE-Line adjustable pedestals

## BASE 1



Art. no.	Name	Assembly height [mm]	Load-bearing capacity [kN]*	PU **
100000	BASE 1	25 - 40	2,2	50

## BASE 2



Art. no.	Name	Assembly height [mm]	Load-bearing capacity [kN]*	PU **
100001	BASE 2	35 - 60	2,2	50

## BASE 3



Art. no.	Name	Assembly height [mm]	Load-bearing capacity [kN]*	PU **
100002	BASE 3	60 - 110	2,2	30

## BASE 4



Art. no.	Name	Assembly height [mm]	Load-bearing capacity [kN]*	PU **
100003	BASE 4	110 - 210	2,2	20

**Note:** The BASE-Line is not compatible with the Nivello 2.0

\* The quoted load-bearing capacities represent recommended values. With these loads, the adjustable pedestals only deform by approx. 2 mm. The load-bearing capacity before actual fracture is multiple times higher.

\*\* The BASE adjustable pedestal is supplied with the BASE L adapter and one screw each per adjustable pedestal as standard. If the BASE adjustable pedestals are used for aluminium, suitable adapters must be purchased too.

The adjustable pedestals series is completed by four different types of adapter:

**BASE L adapter** - for classic timber substructures or modern aluminium substructures

**BASE adapter 32/40/60** - for clicking Eurotec aluminium profiles into place in a time-saving manner

### BASE L adapter

For aluminium or timber profiles

Suitable for the  
BASE 1,2,3 and 4



Art. no.	Name	PU*
	BASE L adapter	

\* The BASE L adapter is included in the scope of delivery as standard.

### BASE adapter 32

For aluminium profiles with Click system

Suitable for EVO Light  
aluminium system profile



Art. no.	Name	PU
100004	BASE adapter 32	10

### BASE adapter 40

For aluminium profiles with Click system

Suitable for Eveco aluminium  
system profile



Art. no.	Name	PU
100005	BASE adapter 40	10

### BASE adapter 60

For aluminium profiles with Click system

Suitable for EVO/EVO Slim  
aluminium system profile and  
HKP deck-support profile



Art. no.	Name	PU
100006	BASE adapter 60	10



# Adjustable pedestal SL BASE

**NEW**  
to our product range

## Adjustable pedestal SL BASE



Art. no.	Name	Assembly height [mm]	Load-bearing capacity [kN]*	PU
100000-SL	Adjustable pedestal SL BASE S with L adapter	32 - 47	2,2	40
100001-SL	Adjustable pedestal SL BASE M with L adapter	42 - 67	2,2	30
100002-SL	Adjustable pedestal SL BASE L with L adapter	67 - 117	2,2	30
100003-SL	Adjustable pedestal SL BASE XL with L adapter	117 - 217	2,2	20

The height-adjustable support pedestals are suitable for predominantly static, centric compressive stress in multiple-supported systems.

\*The quoted load-bearing capacities represent recommended values. With these loads, the adjustable pedestals only deform by approx. 2 mm. The load-bearing capacity before actual fracture is multiple times higher.

### Description

The Eurotec adjustable pedestal SL BASE is ideal for the laying of decking substructures for outdoor use. The head of the adjustable pedestal SL BASE is self-adjusting and compensates for slopes on surfaces and terrain unevenness of up to 7%.

The adjustable pedestal SL BASE also allows the simple creation of slopes of 1 – 2% of the terrace surface for draining purposes.

### Advantages

- Continuous self-adjusting of up to 7%
- Suitable for substructures of aluminium and wood
- Available in four different sizes
- Can be combined with SL BASE-L-adapter, 40 and 60
- Body heights of 32 - 217 mm
- Load capacity of up to 2,2 kN/pedestal

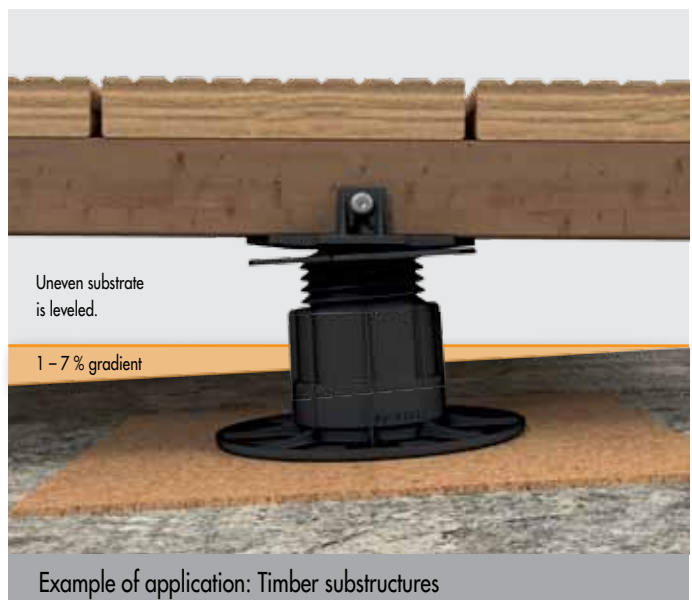
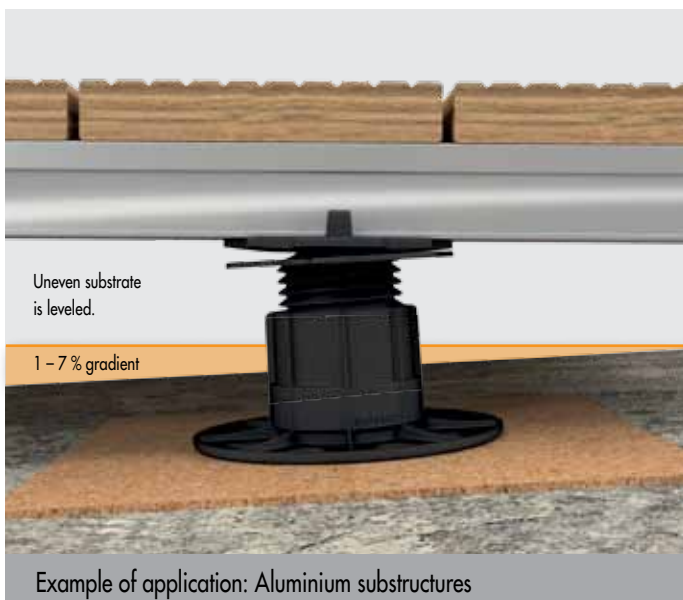



The adjustable pedestals SL BASE is completed by three different types of adapter:

- SL BASE-L-adapter** - for classic timber substructures or modern aluminium substructures
- SL BASE-adapter 40** - for clicking Eurotec aluminium profiles into place in a time-saving manner
- SL BASE-adapter 60** - for clicking Eurotec aluminium profiles into place in a time-saving manner

### SL BASE-L-adapter

For aluminium or timber profiles



Art. no.	Name	PU*
	SL BASE-L-adapter	

\* The SL BASE-L-adapter is included in the scope of delivery as standard.

### SL BASE-adapter 40

For aluminium profiles with Click system

Suitable for Eveco aluminium system profile



Art. no.	Name	PU
100005-SL	SL BASE-adapter 40	10

### SL BASE-adapter 60

For aluminium profiles with Click system

Suitable for EVO/EVO Slim aluminium system profile and HKP deck-support profile



Art. no.	Name	PU
100006-SL	SL BASE-adapter 60	10

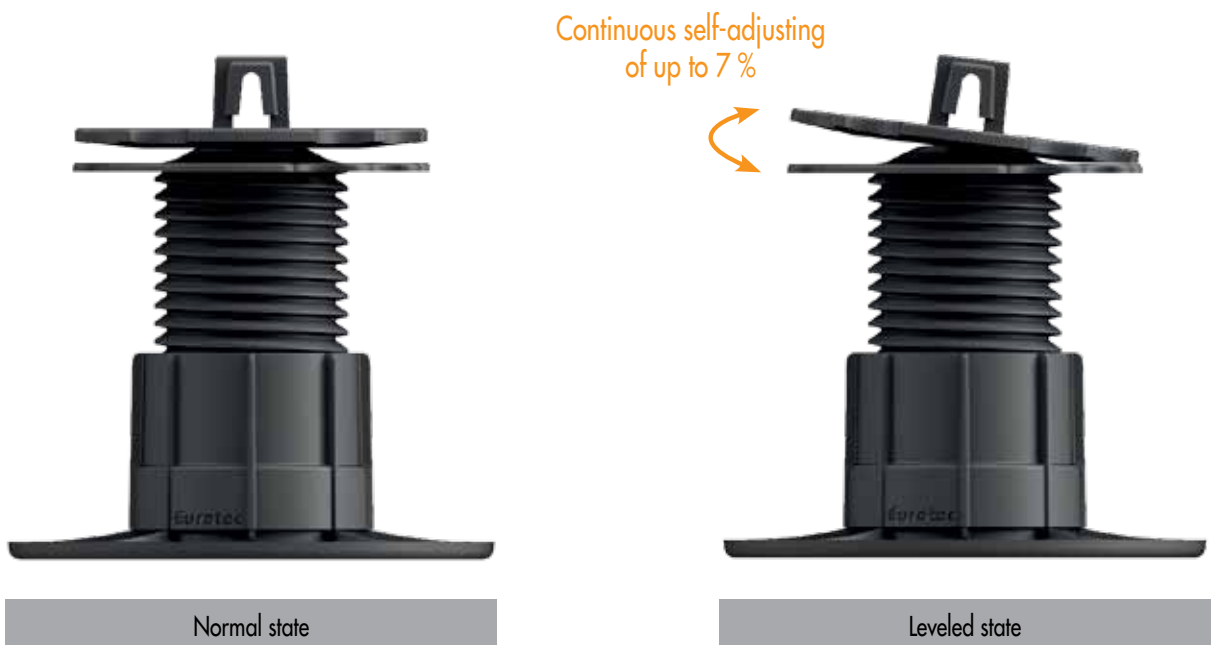

# Profi-Line adjustable pedestals with modular system

**Innovative, universal, versatile and user-friendly!**

The Profi-Line adjustable pedestal series comprises four adjustable pedestals of different heights whose assembly heights can be altered using extension rings.

## PRO XXS



Art. no.	Name	Assembly height [mm]	Load-bearing capacity [kN]*	PU
954020	PRO XXS	10 - 15	4,0	50

The PRO XXS comes with both an L-adapter and stone adapter.

The adjustable foot XXS can be combined with up to two extension plates for height expansion.

**Note:** The adapters for the XXS adjustable pedestal are only suitable for the XXS and cannot be combined with the rest of the PRO family. Not compatible with the Nivello 2.0.

## XXS extension plate

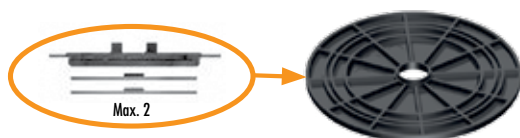

Art. no.	Name	Assembly height [mm]	Load-bearing capacity [kN]*	PU
954021	XXS extension plate	5	4,0	50

## PRO XS / PRO S



Art. no.	Name	Assembly height [mm]	Load-bearing capacity [kN]*	PU
954061	PRO XS	22 - 30	8,0	20
946070	PRO S	30 - 53	8,0	10

The PRO XS comes with both an L-adapter and stone adapter.

PRO S: Height adjustable in 3 stages of 5 mm each and an additional 8 mm can be combined with the thread.

**Note:** The adapters for the XS adjustable pedestal are only suitable for the XS and cannot be combined with the rest of the PRO family. The adjustable pedestal XS is not compatible with the Nivello 2.0.

## PRO M



Art. no.	Name	Assembly height [mm]	Load-bearing capacity [kN]*	PU
946071	PRO M	53 - 82	8,0	10

## PRO L

Fixing by means of Thermofix screw 4.2 x 22 mm (item no. 945969, see page 93) is possible on all PRO pedestals.



Art. no.	Name	Assembly height [mm]	Load-bearing capacity [kN]*	PU
946072	PRO L	70 - 117	8,0	10

\* The quoted load-bearing capacities represent recommended values. With these loads, the adjustable pedestals only deform by approx. 2 mm. The load-bearing capacity before actual fracture is multiple times higher.

## PRO XL



Art. no.	Name	Assembly height [mm]	Load-bearing capacity [kN]*	PU
946079	PRO XL	74 - 168	8,0	10

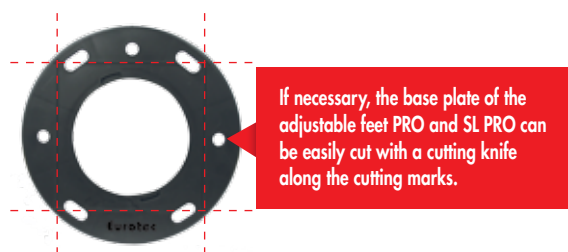

The adjustable pedestals series is completed by three different types of adapter:

**L adapters** - for classic timber substructures or modern aluminium substructures

**Click adapters** - for clicking Eurotec aluminium profiles into place in a time-saving manner

**Stone adapters** - for laying stone slabs

## Extension rings

For increasing the height of the PRO adjustable pedestals



Suitable for the PRO S, M, L and XL as well as SL PRO M and L adjustable pedestals

Art. no.	Name	Assembly height [mm]	Load-bearing capacity [kN]*	PU
946069	Extension ring + 2	20	8,0	10
946074	Extension ring + 4	40	8,0	10
946073	Extension ring +10	100	8,0	10

## L adapter

For aluminium or timber profiles

Suitable for the PRO S, M, L and XL as well as SL PRO M and L adjustable pedestals

**incl.**  
one screw  
per adapter!



Art. no.	Name	PU
946075	L adapter	10

## Click adapter

For aluminium profiles with Click system



### Click adapter 40

for Eveco aluminium system profile.  
Suitable for PRO S - PRO XL

### Click adapter 60

for EVO/EVO Slim aluminium system profile and HKP deck-support profile.  
Suitable for PRO S - PRO XL

Art. no.	Name	PU
946076	Click adapter 40	10
946077	Click adapter 60	10

## Stone adapter

For stone slabs

Suitable for the PRO S, M, L and XL adjustable pedestals



Art. no.	Name	Dimension joint spacer [mm] <sup>a)</sup>	PU
946078	Stone adapter	8 x 14 x 4	10

<sup>a)</sup> Height x length x width

### Possible combinations

Adjustable pedestals	L adapter	Click adapter 40	Click adapter 60	Stone adapter	L/stone adapter XXS	L/stone adapter XS
PRO XXS					X	
PRO XS						X
PRO S	X	X	X	X		
PRO M	X	X	X	X		
PRO L	X	X	X	X		
PRO XL	X	X	X	X		
SL PRO M	X					
SL PRO L	X					

\* The quoted load-bearing capacities represent recommended values. With these loads, the adjustable pedestals only deform by approx. 2 mm. The load-bearing capacity before actual fracture is multiple times higher.



# SL PRO adjustable pedestals

The Eurotec SL PRO adjustable pedestal is suitable for installing deck substructures in outdoor applications. The head of the SL PRO adjustable pedestal features stepless self-levelling and ensures that slopes of up to 8% on surfaces and uneven ground can be evened out.

The most important advantage is, that no additional slope compensation is required to establish the correct alignment of the covering surface. The SL PRO adjustable pedestal therefore allows the easy creation of an inclination of 1-2% on deck surfaces for drainage purposes.

**Advantages**

- Self-levelling for slopes of up to 8 %
- UV stability
- High fatigue strength
- Stepless height adjustment from 55 to 102 mm
- Excellent chemical resistance
- Acoustic damping properties



## SL PRO M



Art. no.	Name	Assembly height [mm]*	Load-bearing capacity [kN]	PU
946071-SL	SL PRO M	55 - 84	8,0	10

\* The adapter must be attached to produce an assembly height in the adjustment range!

## SL PRO L



Art. no.	Name	Assembly height [mm]*	Load-bearing capacity [kN]	PU
946072-SL	SL PRO L	73 - 102	8,0	10

\* The adapter must be attached to produce an assembly height in the adjustment range!

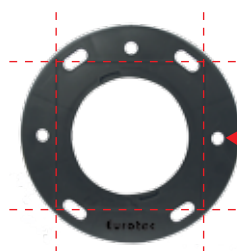

If necessary, the base plate of the adjustable feet PRO and SL PRO can be easily cut with a cutting knife along the cutting marks.

# Nivello 2.0

For PRO-Line adjustable pedestals

## Nivello 2.0



Art. no.	Slope (%)	PU
946035	0,5 - 10	10

- User-friendly operation
- Versatile slope adjustment
  - Minimum slope: 0,5 %
  - Maximum slope: 10 %
  - Slope can be adjusted in steps of 0,5 %
- Click-locking of adjustable pedestals
- Bearing surface composition protects subsurface (e.g. roofing)
- Large bearing surface

**Note** Not compatible with adjustable pedestals PRO XS, PRO XXS and BASE-Line.

# Aids for installing stone slabs

## Slab supports

- Support height: 10 mm
- Joint spacer: 4 mm
- Up to three units can be stacked on top of one another
- Dampens footfall noise



Art. no.	Dimensions [mm] <sup>a)</sup>	Material	PU
945432	Ø 120 x 18/10	EPDM, black	45

a) Outside diameter x total height/Support height of a plate bearing

### Also ideal for your roof terrace

Thanks to modern slab support and special adjustable pedestals for slabs, it is now possible to lay floor slabs easily and without mortar. The different support heights of the slab supports and adjustable pedestals allow you to easily correct height differences in the subfloor and to cover up unsightly outflows and drains. You can therefore achieve an even surface with little effort. Any surface water that arises can run off quickly and easily through the seams.

In order to achieve an even surface with the stone slabs, the height can be adjusted down to the last millimetre using gearwheels in the Quattro-Lager.

## Quattro Lager

With slab spacer

- Four different support heights are possible thanks to individually adjustable gearwheels
- Support height: 35 - 55 mm
- Joint spacer: 6 mm
- The height can be extended by placing the Quattro-Lager adapter underneath
- Can be split



Art. no.	Dimensions [mm]	Load capacity per corner [kN]*	Total load capacity [kN]*	PU
945340	Ø 150 x 35 - 55	2,0	8,0	15

## Adapter

For Quattro Lager

- Support height: 20 mm
- Can be split
- Stackable



Art. no.	Dimensions [mm]	Total load capacity [kN]*	PU
945342	Ø 150 x 20	8,0	20

\* The quoted load-bearing capacities represent recommended values. With these loads, the adjustable pedestals only deform by approx. 2 mm. The load-bearing capacity before actual fracture is multiple times higher.

# Stone slab spacers

The simple aids for installing stone slabs

## Stone slab spacer



15 x 53 x 3 mm    30 x 53 x 3 mm    15 x 53 x 5 mm    30 x 53 x 5 mm

Art. no.	Dimensions [mm] <sup>a)</sup>	Material	PU
945336	15 x 53 x 3	PP	100
945338	30 x 53 x 3	PP	100
945335	15 x 53 x 5	PP	100
945337	30 x 53 x 5	PP	100

<sup>a)</sup> Bridge height x length x joint dimension

## Stone slab spacer

With baseplate

Large baseplate prevents slab spacers from being pressed into gravel bed



Art. no.	Dimensions [mm] <sup>a)</sup>	Material	PU
945339	15 x 53 x 3	PP	100

<sup>a)</sup> Bridge height x length x joint dimension

### Advantages of stone slab spacers

- Uniform joint pattern
- Optimum drainage
- They prevent the floor slabs from rubbing against one another and therefore prevent damage to the slab edges.
- They have predetermined breaking points and are therefore suitable for T-joints and cross joints.
- Durable
- Resistant to temperature and weathering
- Resistant to acids, alkalis and other chemicals

### Quantity calculation for laying floor slabs

Floor slab	Pieces/m <sup>2</sup>
40 x 40 cm	ca. 7,8
50 x 50 cm	ca. 4,8
40 x 60 cm	ca. 5,6
60 x 60 cm	ca. 4,0

There are approximate figures based on an area of 25 m<sup>2</sup> (5 x 5 m).

# Accessories

## Compensation disk Ø90



Art. no.	Dimensions [mm]	PU
954089	Ø 90; height 2,5	50

- For balancing out unevenness in the slabs
- Can be mounted on the adjustable pedestals from the Profi-Line series, SL PRO series and BASE-Line series with stone adapter, as well as on the Stone-Edge-Clip, Flex-Stone-Clip and the plate bearing
- Can be split into up to four parts

## Stone slab lifter



Art. no.	Span [cm]	Nominal Load [kg]	PU
954045	30,0 - 50,0	25	1

- Simplifies and speeds up the lifting and laying of floor slabs
- Also suitable for subsequent lifting of already laid slabs



# Aids for laying slabs and tiles

The Eurotec Level Mate is a reusable levelling system for tiles. The system is also suitable for use by both experienced tradespeople and DIY enthusiasts. The Level Mate is particularly suitable when using slabs and tiles.

## Level Mate Spin

After inserting the Level Mate Spin into the joint, turn it by 90° and thus hook it on the underside of the tile. Hold the red handle first of all and turn the black nut tightly around the slabs to level them. To remove the Level Mate, loosen the black nut and turn the red handle by 90° again.



### Advantages

- Easy to assemble
- No embedded base
- No consumables
- Reusable
- No additional components needed

Art. no.	Name	PU
945346	Level Mate Spin	20

For joint widths of 1,5 mm to 5 mm.  
Slab thicknesses of 3 mm to 15 mm.

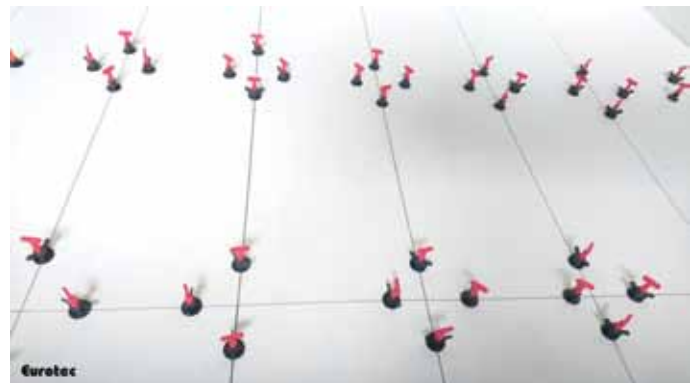

## Level Mate Flip

After inserting the Level Mate Flip, turn it by 90° and thus hook it on the underside of the tile. You can level your slabs by folding down the red lever. Thanks to the snap-in function, it can be used for all standard slab thicknesses. To remove the Level Mate Flip, loosen the lever and turn it by 90° again.



Art. no.	Name	PU
945347	Level Mate Flip	20

For joint widths of 2 mm to 5 mm.  
Slab thicknesses of 8 mm to 11 mm.

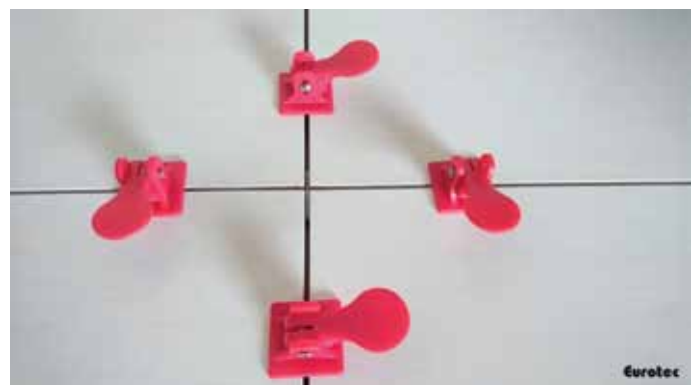

## 3 mm spacer



Art. no.	Name	PU
945348	3 mm spacer	200

# Robusto deck pedestal

Robusto deck pedestal HV 500+350



## What can it be used for?

- Deck construction
- For example, for the construction of barrier-free ramps and transitions
- Thanks to its U-shaped head plate, the Robusto HV 500+350 can support not only the Eurotec HKP deck-support profile but also the EVO aluminium system profile and timber substructure profiles.

## Properties

- Meets the requirements for structural wood protection

## Advantages

- An EPDM gasket between the head plate and substructure provides additional protection against footfall sound and penetrating moisture
- The height of the post foot can be adjusted to up to 850 mm after assembly
- Thanks to the height adjustment, manufacturing tolerances relating to the structure and subsequent settlement in the individual foundations can be balanced out
- High tensile and compressive load capacities

## Notes

- The durability of the pedestals is ensured thanks to hot-dip galvanisation in accordance with DIN EN ISO 12944-2 (C3).



Suitable for this:  
Rock concrete screw hexagonal  
BIM A2 10,5 x 95 mm  
Art. no.: 110355



The deck pedestal in combination with the HKP deck-support profile



With the deck pedestal, it is possible to build accessible ramps and transitions



#### Brief technical description

- Simple assembly with U-shaped head plate
- Can be combined with the HKP deck-support profile and the EVO aluminium system profile
- Min. timber cross section of 60 x 100 mm
- Additional timber protection thanks to EPDM for timber
- Hot-dip galvanised structural steel S235JR (ST37-2)
- Can be used in the usage classes 1, 2 and 3 in accordance with DIN EN 1995-1 -1
- The Robusto HV 500+350 allows constructive timber protection in accordance with the new DIN 68800-2
- In addition to the vertical loads, the Robusto HV 500+350 can also transfer horizontal forces into the subsurface

Name	Art. no.	Height adjustment in assembled state	Min. post cross section	Dimensions of baseplate	Compressive load-bearing capacity	Tensile load-bearing capacity	Lateral force resistance <sup>1)</sup>	PU
Post feet on concrete		[mm]	[mm]	L x W x H [mm]	N <sub>c,d</sub> [kN]	N <sub>t,d</sub> [kN]	VR <sub>d</sub> [kN]	pcs.
Robusto HV 500+350	904661	500 - 850	60 x 100	160 x 100 x 8	21,2	9,2	-	2

#### Please note

The stated values are intended as planning aids. They are subject to typographical and printing errors. Projects must only be calculated by authorised persons.

1) The lateral force resistance must be overlaid with the compressive and tensile load in accordance with ETA 13-/0550 and can therefore lead to lower load-bearing capacities.



# Overview of Eurotec aluminium profiles

## Properties / advantages

- Form-stable, always straight, load-bearing, torsion-free
- Resistant to weather, UV exposure, insects and rot
- The special shape of the profiles reduces the risk of fastening screws shearing off as a result of swelling and shrinking movements of the deck boards
- Supporting constructive timber protection

## EVO aluminium system profile

- Suitable for Profi-Line and BASE-Line adjustable pedestals
- For visible and hidden fastening of deck boards, e.g. Twin System Clip
- Can be extended using EVO/EVO Slim aluminium system-profile connectors

## EVO Slim aluminium system profile

- Suitable for Profi-Line and BASE-Line adjustable pedestals
- For visible and hidden fastening of deck boards, e.g. Twin System Clip
- Can be extended using EVO Slim aluminium system-profile connectors
- Especially designed to suit low assembly heights

## EVO Light aluminium system profile

- Developed specially for BASE adjustable pedestals
- For visible and hidden fastening of deck boards, for example with the EVO Light system clip
- Can be extended using EVO Light system connector





### Eveco aluminium system profile

- Developed specially for PRO adjustable pedestals with Click adapter
- In case of low structure height, the profile can be used without pedestals
- The aluminium profiles are simply clicked into place – with no need for screwing
- Hidden fastening of deck boards with ECO system clip
- Can be extended using ECO system connector

### HKP deck support system

- Suitable for Profi-Line and BASE-Line adjustable pedestals
- For bridging large spans
- Consists of two system parts
- For visible and hidden fastening of deck boards

### Aluminium function strips

- Used without adjustable pedestals
- For low assembly heights
- With footfall sound insulation thanks to glued-in cork insert
- For visible fastening of deck boards

### DiLo aluminium function strip

- Used without adjustable pedestals
- For low assembly heights
- For hidden fastening of deck boards

# EVO aluminium system profile

The EVO aluminium system profile is one of the alternatives to a deck substructure made of timber.

- In contrast to timber substructures, the profile is dimensionally stable and straight
- It doesn't suffer from climate-related effects such as warping, cracks, etc. that naturally occur with timber.
- The special shape prevents the screws from shearing off
- Allows both hidden and visible fastening



Example:  
Adjustable pedestal  
PRO with L adapter



Hidden fastening using a deck glider on a Black Edition EVO aluminium system profile



Visible fastening using a profile drilling screw on an EVO aluminium system profile

## EVO/EVO Black Edition aluminium system profile



Art. no.	Dimensions [mm] <sup>a)</sup>	Material	PU
975621	40 x 60 x 2400	Aluminium	1
975610	40 x 60 x 4000	Aluminium	1
S975621	40 x 60 x 2400	Aluminium, black	1
S975610	40 x 60 x 4000	Aluminium, black	1

<sup>a)</sup> Height x Width x Profile length



Use the aluminium concrete bracket (Art.-no.: 975661) for fixing to concrete. Find more information on page 68

Cross-section values <sup>b)</sup>		
E-Modul [N/mm <sup>2</sup> ]	Wy [mm <sup>3</sup> ]	Iy [mm <sup>4</sup> ]
70000	3438	70480

Wy = section modulus; Iy = geometrical moment of inertia



Max. support spacing L [mm] for EVO aluminium system profile with adjustable pedestals<sup>a)</sup>

Payload [kN/m <sup>2</sup> ]	BASE-Line adjustable pedestals, perm. F = 2,2 kN							
	Centre distance e [mm] between the profiles <sup>b)</sup>							
	300	350	400	450	500	550	600	800
2,0	1000	1000	900	800	750	600	600	450
4,0 <sup>c)</sup>	750	650	550	500	450	400	350	250
5,0 <sup>d)</sup>	650	550	450	400	350	350	300	-

Payload [kN/m <sup>2</sup> ]	Profi-Line adjustable pedestals, perm. F = 8,0 kN							
	Centre distance e [mm] between the profiles							
	300	350	400	450	500	550	600	800
2,0	1000	1000	1000	950	900	850	850	750
3,0 <sup>c)</sup>	1000	950	900	850	850	800	800	700
4,0 <sup>c)</sup>	900	850	850	800	750	750	700	650
5,0 <sup>d)</sup>	850	800	800	750	700	700	650	600

<sup>a)</sup> Indication of max. span at which the profile's deflection does not exceed L/300. Average board thickness of 25 mm with a specific weight of 7 kN/m<sup>2</sup> (larch, pine, Douglas fir).

<sup>b)</sup> e.g.: spacing between profiles = 550 mm; payload = 2,0 kN/m<sup>2</sup> → max. span of the profile = 600 mm.

<sup>c)</sup> Payloads according to DIN EN 1991-1; roof terraces = 4 kN/m<sup>2</sup>, patios for public use = 5 kN/m<sup>2</sup>.

<sup>d)</sup> Load capacity according to SIA 261 for balconies and roof terraces private use = 3 kN/m<sup>2</sup>

## Cross bracing EVO

**NEW**  
to our product range



### Product description

Our cross bracing is the perfect complement to our aluminium profiles. The pre-mounted brackets make installation even easier.

### Advantages

- Simple, time-saving assembly
- Faster completion of the terraces
- The prefabricated cross bracing prevents the costly process of cutting the profiles on the construction site.
- Clean prefabrication ensures professional assembly

### Instructions for use

The cross bracings can only be used with a centre distance of 40 mm.

Art. no.	Name	Material	Dimensions [mm] <sup>a)</sup>	PU
975666	Cross bracing EVO	Aluminium	60 x 40 x 340	1

<sup>a)</sup> Height x Width x Profile length

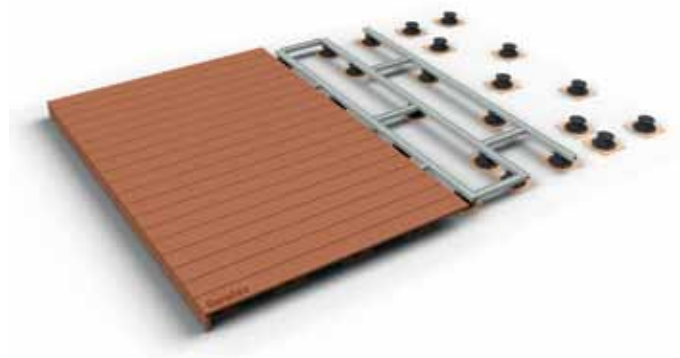

## EVO aluminium system profile connector



**Note**

The profile butt joint is only to be positioned directly above a post or support.

Art. no.	Dimensions [mm] <sup>1)</sup>	Material	PU*
975611	24 x 200 x 50	Aluminium	10

<sup>1)</sup> Height x length x width

\*Incl. 4 drilling screws per connector

Example of fixing an EVO aluminium profile connector



## EVO corner connector



Art. no.	Dimensions [mm] <sup>1)</sup>	Material	PU
975612-10	40 x 40 x 25	Aluminium	10*
975612-200	40 x 40 x 25	Aluminium	200**

<sup>1)</sup> Height x length x width

\* incl. 40 screws

\*\* incl. 800 screws







# EVO wall-connection bracket / EVO position anchor

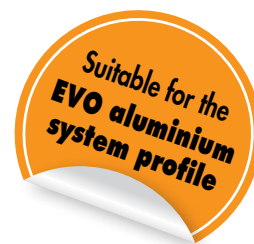

## EVO wall-connection bracket

### Properties

- Slot diameter: 6 mm or 7 mm
- Slot length: 15 mm
- Material thickness: 3 mm



Art. no.	Dimensions [mm]	Material	PU*
975627	100 x 30	Aluminium	10

\* Supplied with 1 drilling screw per wall-connection bracket for attachment to the EVO aluminium system profile.

The **EVO wall-connection bracket** is ideal for use as a position anchor for deck substructures made of aluminium. The bracket is used to fasten the EVO aluminium system profile directly to the wall. Two EVO wall-connection brackets are needed per aluminium profile. The slots in the wall-connection bracket allow the substructure to expand without problems and therefore prevent it from shifting out of position.



## EVO position anchor

### Advantages

- Versatile applications
- Corrosion-resistant
- Easy to use



Art. no.	Dimensions [mm] <sup>1)</sup>	Thickness [mm]	Material	PU*
975622	27,5 x 49 x 23,5	2,5	Zinc die-cast	10

<sup>1)</sup> Height x length x width

\* Comes supplied with screws

The EVO position anchor provides a simple and straightforward solution for joining Eurotec EVO aluminium system profiles. Thanks to the EVO position anchor, the aluminium profiles can be joined at an angle of between 30° and 90°.



View of substructure from below

## 90° / 180° EVO joint

EVO pivots are used to join the EVO aluminium system profiles. The pivots can rotate freely on both sides and can be used for angles of up to 90° or 180° in deck substructures.

### 90° EVO joint

#### Advantages

- Freely rotating joint
- For angles of up to 90°
- Individual positioning in the EVO system profile
- Rivet is made of stainless steel A2 according to DIN6791

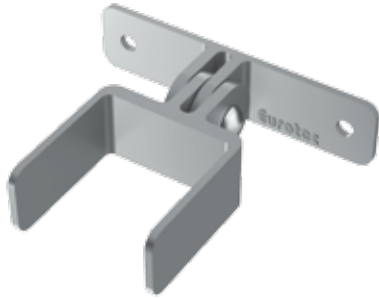

Art. no.	Dimensions [mm] <sup>ⓐ</sup>	Material	PU*
975623	23,5 x 84,0 x 100	Zinc die-cast	4

<sup>ⓐ</sup> Height x length x width

\* For fastening, we recommend using BiGHTY PH drilling screws (954068). These are not included in the product.



### 180° EVO joint

#### Advantages

- Freely rotating joint
- For angles of up to 180°
- Individual positioning in the EVO system profile
- Rivet is made of stainless steel A2 according to DIN6791

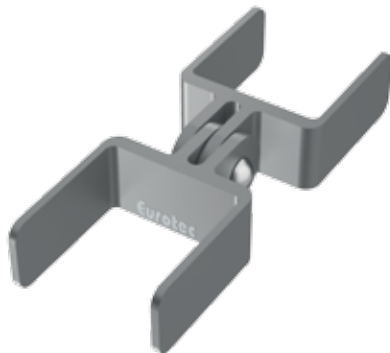

Art. no.	Dimensions [mm] <sup>ⓐ</sup>	Material	PU*
975624	23,5 x 131,5 x 49,25	Zinc die-cast	4

<sup>ⓐ</sup> Height x length x width

\* For fastening, we recommend using BiGHTY PH drilling screws (954068). These are not included in the product.



# EVO Slim aluminium system profile

The EVO Slim aluminium system profile is especially developed to suit low assembly heights. It can be combined with our BASE-Line and Profi-Line adjustable pedestals and is therefore also ideal for the multifunctional Stone System.

## EVO Slim aluminium system profile

Art. no.	Dimensions [mm] <sup>a)</sup>	Material	PU
975633	20 x 60 x 2400	Aluminium	1
975628	20 x 60 x 4000	Aluminium	1

<sup>a)</sup> Height x Width x Profile length



**Important!** If the Aluminium-System Profile EVO-Slim is installed in combination with the Twin system clip, the note on page 89 needs to be considered.

## EVO Slim aluminium system profile connector

Art. no.	Dimensions [mm] <sup>a)</sup>	Material	PU*
975629	4 x 48 x 200	Aluminium	10

<sup>a)</sup> Height x width x length

\*Incl. 4 drilling screws per connector



**Note**

The profile butt joint is only to be positioned directly above a post or support.

### Max. support spacing L [mm] for EVO Slim aluminium system profile with adjustable pedestals<sup>a)</sup>

Payload [kN/m <sup>2</sup> ]	BASE-Line adjustable pedestals, perm. F = 2,2 kN							
	Centre distance e [mm] between the profiles <sup>b)</sup>							
	250	300	350	400	450	500	550	600
2,0	650	600	600	550	550	500	500	500
3,0 <sup>d)</sup>	550	550	500	500	500	450	450	400
4,0 <sup>d)</sup>	500	500	450	450	400	400	400	400
5,0 <sup>d)</sup>	500	450	450	400	400	400	350	350

Payload [kN/m <sup>2</sup> ]	Profi-Line adjustable pedestals, perm. F = 8,0 kN							
	Centre distance e [mm] between the profiles <sup>b)</sup>							
	250	300	350	400	450	500	550	600
2,0	650	600	600	550	550	500	500	500
3,0 <sup>d)</sup>	550	550	500	500	500	450	450	400
4,0 <sup>d)</sup>	500	500	450	450	400	400	400	400
5,0 <sup>d)</sup>	500	450	450	400	400	400	350	350

<sup>a)</sup> Indication of max. span at which the profile's deflection does not exceed L/300. Average board thickness of 25 mm with a specific weight of 7 kN/m<sup>3</sup> (larch, pine, Douglas fir).

<sup>b)</sup> e.g.: spacing between profiles = 550 mm; payload = 2,0 kN/m<sup>2</sup> → max. span of the profile = 500 mm.

<sup>c)</sup> Payloads according to DIN EN 1991-1-1; roof terraces = 4 kN/m<sup>2</sup>, patios for public use = 5 kN/m<sup>2</sup>.

<sup>d)</sup> Load capacity according to SIA 261 for balconies and roof terraces private use = 3 kN/m<sup>2</sup>.

**Note**

Please refer to the assembly instructions in our product data sheet.





## Accessories for the multifunctional Stone System

### Flex-Stone-Clip

For clicking onto the EVO aluminium system profile within the paving



Art. no.	Joint spacer dimensions [mm] <sup>1)</sup>	PU*
975602	8 x 14 x 4	200

<sup>1)</sup> Height x length x width

\* For fastening, we recommend using Aluminium profile drilling screw (645026).  
These are not included.

#### Note

The flexibility of the Flex-Stone-Clip allows it to compensate for manufacturing tolerances of up to 2 mm in stone slabs.

### Stone-Edge-Clip

For clicking onto the EVO aluminium system profile at the edges



Art. no.	Joint spacer dimensions [mm] <sup>1)</sup>	PU*
975603	8 x 14 x 4	50

<sup>1)</sup> Height x length x width

\* Comes supplied with one screw per clip.

To prevent individual stone slabs from slipping, the stone edge clips are to be screwed to the aluminium substructure in the edge area. The clips have a screw channel in the middle for this purpose.

### Aluminium profile drilling screw



Art. no.	Dimensions [mm]	Drive	PU
645026	4,2 x 35	TX15 •	100

# EVO Light aluminium system profiles + accessories

## EVO Light aluminium system profile



Art. no.	Dimensions [mm] <sup>1)</sup>	Material	PU
975643	32 x 34 x 4000	Aluminium	1

<sup>1)</sup> Height x Width x Profile length



Use the aluminium concrete bracket (Art.-no.: 975661) for fixing to concrete. Find more information on page 68

### Properties

- Hidden fastening with the EVO Light system clip
- Visible fastening with Eurotec profile drilling screws and wing-tipped profile drilling screws
- Developed specially for BASE adjustable pedestals
- Can also be used with PRO adjustable pedestals and L adapter
- Can be extended using ECO Light system connector
- Position retention due to screw of L adapter
- Load-bearing, torsion-free, form-stable and straight
- Special shape prevents screws from shearing off

## EVO Light system connector



Art. no.	Dimensions [mm] <sup>1)</sup>	Material	PU
975618	27,7 x 27,4 x 62,5	Plastic	10

<sup>1)</sup> Height x width x length



For connecting the aluminium EVO Light system profiles together. The EVO Light system connector has the advantage that it connects the profiles without screws, simply by plugging them together.

## Corner connectors

Suitable for EVO Light aluminium system profiles

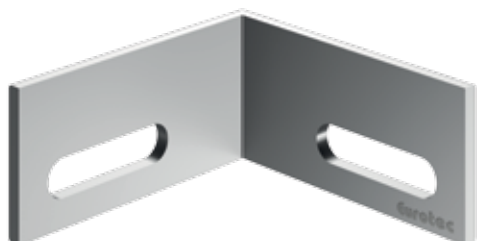

Art. no.	Dimensions [mm] <sup>1)</sup>	Material	PU*
975631	40 x 19 x 40	Aluminium	10

<sup>1)</sup> Height x width x length

\* incl. 20 screws

Max. support spacing (L) for EVO Light aluminium system profile without adjustable pedestals, e.g. on concrete foundations<sup>d)</sup>

Payload [kN/m <sup>2</sup> ]	Centre distance e [mm] between profiles <sup>b)</sup>							
	250	300	350	400	450	500	550	600
2,0	950	900	850	850	800	750	750	700
4,0 <sup>a)</sup>	800	750	700	650	600	600	600	550
5,0 <sup>a)</sup>	700	700	650	600	550	550	550	500

<sup>a)</sup> Max. support spacing (L) for load capacities of 2, 4 and 5 kN/m<sup>2</sup>, with an average board thickness of 25 mm and a specific board weight of 7 kN/m<sup>3</sup> (larch, pine, Douglas fir).

<sup>b)</sup> If WPC boards are used, the centre distance e between the profiles must not exceed 400 mm!

<sup>d)</sup> Load capacities according to DIN EN 1991-1; roof terraces = 4 kN/m<sup>2</sup>, decks for public use = 5 kN/m<sup>2</sup>.

Max. support spacing (L) for EVO Light aluminium system profile with adjustable pedestals<sup>d)</sup>

Payload [kN/m <sup>2</sup> ]	BASE adjustable pedestals, perm. F = 2,2 kN							
	Centre distance e [mm] between profiles <sup>b)</sup>							
	250	300	350	400	450	500	550	600
2,0	950	900	850	850	800	750	750	700
3,0 <sup>a)</sup>	850	800	750	750	700	650	650	600
4,0 <sup>a)</sup>	800	750	700	650	600	550	500	450
5,0 <sup>a)</sup>	700	700	650	550	500	450	400	350

Payload [kN/m <sup>2</sup> ]	PRO adjustable pedestals, perm. F = 8,0 kN							
	Centre distance e [mm] between profiles <sup>b)</sup>							
	250	300	350	400	450	500	550	600
2,0	950	900	850	850	800	750	750	700
3,0 <sup>a)</sup>	850	800	750	750	700	650	650	600
4,0 <sup>a)</sup>	800	750	700	650	600	600	600	550
5,0 <sup>a)</sup>	700	700	650	600	550	550	550	500

<sup>a)</sup> Max. support spacing (L) for load capacities of 2, 3, 4 and 5 kN/m<sup>2</sup>, with an average board thickness of 25 mm and a specific board weight of 7 kN/m<sup>3</sup> (larch, pine, Douglas fir).

<sup>b)</sup> If WPC boards are used, the centre distance e between the profiles must not exceed 400 mm!

<sup>d)</sup> Load capacities according to DIN EN 1991-1; roof terraces = 4 kN/m<sup>2</sup>, decks for public use = 5 kN/m<sup>2</sup>.

<sup>e)</sup> Load capacity according to SIA 261 for balconies and roof terraces private use = 3 kN/m<sup>2</sup>.

## MaTre band

For material separation

Suitable for  
EVO, EVO  
Light and  
HKP



The MaTre band is used for material separation and thus prevents creaking noises between the aluminium profiles and planks.

### Advantages

- Easy attachment thanks to an adhesive film
- Optimal fit through a very thin material
- Tear resistant and durable
- Screws can be easily screwed
- Can be cut to length individually

Art. no.	Dimensions [mm] <sup>a)</sup>	PU
945319	0,5 x 10 x 20000	5

<sup>a)</sup> Height x width x length





# Eveco aluminium system profiles + accessories

## Eveco aluminium system profile



Art. no.	Dimensions [mm] <sup>a)</sup>	Material	PU
975632	24 x 39 x 2400	Aluminium	1
975630	24 x 39 x 4000	Aluminium	1

<sup>a)</sup> Height x Width x Profile length



Use the aluminium concrete bracket (Art.-no.: 975661) for fixing to concrete. Find more information on page 68

### Properties

- Can be combined with ECO system clip for hidden fastening
- Universal: can also be used with many other fastening clips (screw diameter: 4,2 mm)
- Developed specially for PRO adjustable pedestals with Click adapter 40
- In case of low structure height, the profile can be used without pedestals
- Position retention thanks to Click system without screws
- Load-bearing, torsion-free, form-stable and straight
- Screw channel avoid's lengthy drilling times

## ECO system connector



Art. no.	Dimensions [mm] <sup>a)</sup>	Material	PU
975614	20 x 30 x 120	Plastic, black	10

<sup>a)</sup> Height x width x length

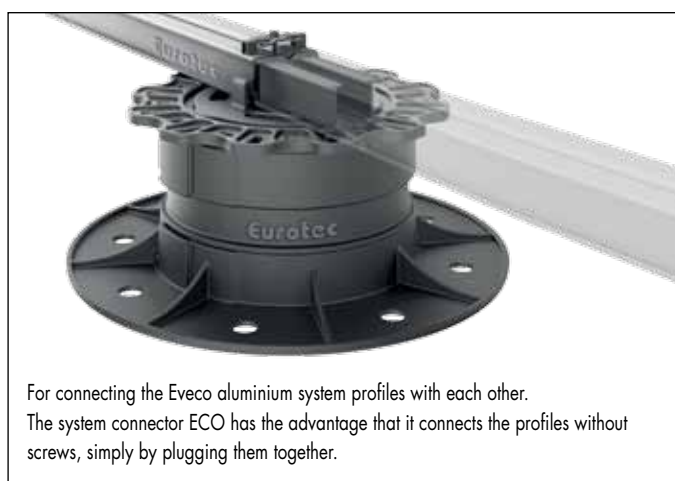

For connecting the Eveco aluminium system profiles with each other. The system connector ECO has the advantage that it connects the profiles without screws, simply by plugging them together.

## Eveco corner connector

For Eveco aluminium system profiles

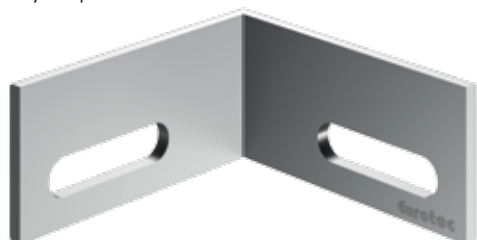

Art. no.	Dimensions [mm] <sup>a)</sup>	Material	PU*
975631	19 x 40 x 40	Aluminium	10

<sup>a)</sup> Height x width x length

\* Incl. 20 screws

Max. support spacing (L) for Eveco aluminium system profile without adjustable pedestals, e.g. on concrete foundations<sup>a)</sup>

Payload [kN/m <sup>2</sup> ]	Centre distance e [mm] between profiles <sup>b)</sup>							
	300	350	400	450	500	550	600	800
2,0	800	750	750	700	700	650	650	600
4,0 <sup>c)</sup>	650	600	600	550	550	500	500	450
5,0 <sup>d)</sup>	600	550	550	500	500	500	450	450

<sup>a)</sup> Indication of max. span at which the profile's deflection does not exceed L/300. Average board thickness of 25 mm with a specific weight of 7 kN/m<sup>3</sup> (larch, pine, Douglas fir).

<sup>b)</sup> e.g.: spacing between profiles = 550 mm; payload = 2,0 kN/m<sup>2</sup> → max. span of the profile = 650 mm.

<sup>c)</sup> Payloads according to DIN EN 1991-1; roof terraces = 4 kN/m<sup>2</sup>, patios for public use = 5 kN/m<sup>2</sup>.

Max. support spacing L [mm] for Eveco aluminium system profile with adjustable pedestals<sup>a)</sup>

Payload [kN/m <sup>2</sup> ]	BASE adjustable pedestals, perm. F = 2,2 kN							
	Centre distance e [mm] between profiles <sup>b)</sup>							
	250	300	350	400	450	500	550	600
2,0	800	750	700	650	650	600	600	600
3,0 <sup>d)</sup>	700	650	600	600	550	550	500	450
4,0 <sup>c)</sup>	650	600	550	550	500	450	400	350
5,0 <sup>d)</sup>	600	550	500	450	400	350	300	300

Payload [kN/m <sup>2</sup> ]	PRO adjustable pedestals, perm. F = 8,0 kN							
	Centre distance e [mm] between profiles <sup>b)</sup>							
	250	300	350	400	450	500	550	600
2,0	800	750	700	650	650	600	600	600
3,0 <sup>d)</sup>	700	650	600	600	550	550	550	500
4,0 <sup>c)</sup>	650	600	550	550	500	500	500	450
5,0 <sup>d)</sup>	600	550	500	500	500	450	450	450

<sup>a)</sup> Indication of max. span at which the profile's deflection does not exceed L/300. Average board thickness of 25 mm with a specific weight of 7 kN/m<sup>3</sup> (larch, pine, Douglas fir).

<sup>b)</sup> e.g.: spacing between profiles = 550 mm; payload = 2,0 kN/m<sup>2</sup> → max. span of the profile = 600 mm.

<sup>c)</sup> Load capacities according to DIN EN 1991-1; roof terraces = 4 kN/m<sup>2</sup>, decks for public use = 5 kN/m<sup>2</sup>.

<sup>d)</sup> Load capacity according to SIA 261 for balconies and roof terraces private use = 3 kN/m<sup>2</sup>.

## Cross bracing Eveco

**NEW**  
to our product range



Art. no.	Name	Material	Dimensions [mm] <sup>a)</sup>	PU
975667	Cross bracing Eveco	Aluminium	24 x 40 x 361	1

<sup>a)</sup> Height x Width x Profile length

## Product description

Our cross bracing is the perfect complement to our aluminium profiles. The pre-mounted brackets make installation even easier.

## Advantages

- Simple, time-saving assembly
- Faster completion of the terraces
- The prefabricated cross bracing prevents the costly process of cutting the profiles on the construction site.
- Clean prefabrication ensures professional assembly

## Instructions for use

The cross bracings can only be used with a centre distance of 40 mm.



# Aluminium concrete bracket

For fixing to concrete

## Aluminium concrete bracket

Aluminium



Suitable for this:  
**EVO aluminium system profile,**  
**EVO Light aluminium system profile,**  
**Evenco aluminium system profile**

Art. no.	Dimensions [mm] <sup>a)</sup>	Ø Round hole [mm]	Slotted hole [mm] <sup>b)</sup>	PU*
975661	19,75 x 22,75 x 30	8	20 x 4,5	10

<sup>a)</sup> Height x length x width

<sup>b)</sup> Length x width

\*Delivery includes one 4,2 x 17 mm Thermofix screw.

The rock concrete screw for fixing to concrete is not included in the scope of delivery and must be ordered separately.

### Instructions for use

The aluminium concrete bracket is fixed to the aluminium through the slotted hole using the 4,2 x 17 mm Thermofix screw supplied. The slotted hole can be used to compensate for material expansion of the aluminium.

The round hole is used for fixing to concrete with the 7,5 mm rock concrete screw hexagonal/hexagonal with flange.



Aluminium concrete bracket in conjunction with the EVO aluminium system profile



Aluminium concrete bracket in conjunction with the EVO Light aluminium system profile



Aluminium concrete bracket in conjunction with the Evenco aluminium system profile





# Aluminium Deck Support System HKP

For bridging wider spans

## One system, many advantages

- High load bearing capability
- Large support widths
- High dimensional stability and evenness
- Low dead load
- High flexibility
- High durability
- Attractive, clean enclosed frame
- Material savings

The deck support system comprises an aluminium substructure that allows spans of up to 3 m, depending on the desired loading capacity. The support system can therefore be tailored flexibly to meet a wide range of requirements. It is used especially on decks installed near to the ground in which only a few auxiliary supports are laid. Its versatile range of applications also includes elevated decks, load-bearing balconies and overhanging decks near to the ground.

The deck support system consists of two components that are joined together to form a closed, load-bearing system.







The two parts of the system form a complete deck substructure

### Support-profile HKP



Art. no.	Dimensions [mm] <sup>a)</sup>	Material	PU
954669	100 x 60 x 4000	Aluminium	1

<sup>a)</sup> Height x Width x Profile length

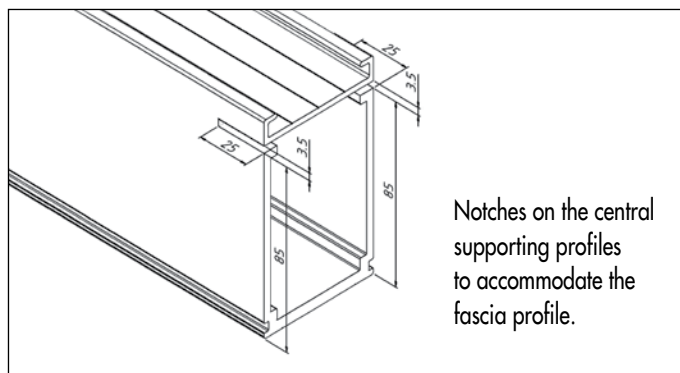

### Fascia profile HKP



Art. no.	Dimensions [mm] <sup>a)</sup>	Material	PU
954668	104 x 50 x 4000	Aluminium	1

<sup>a)</sup> Height x Width x Profile length

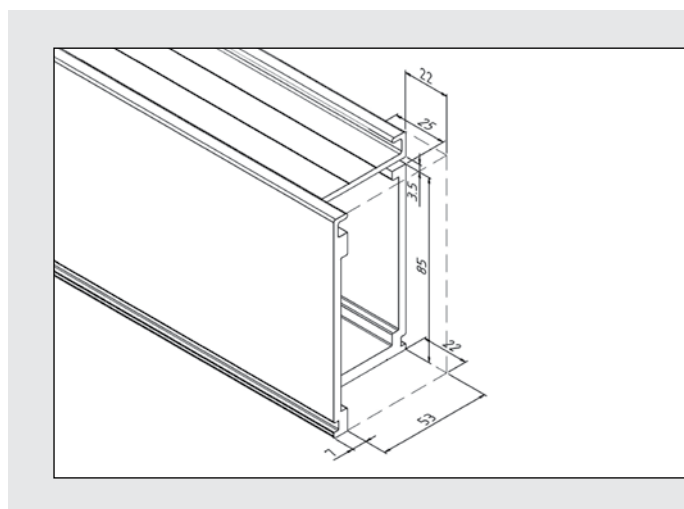
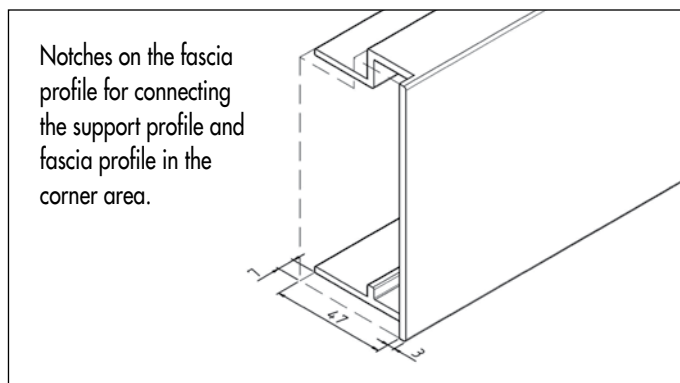

Notches on the fascia profile for connecting the support profile and fascia profile in the corner area.

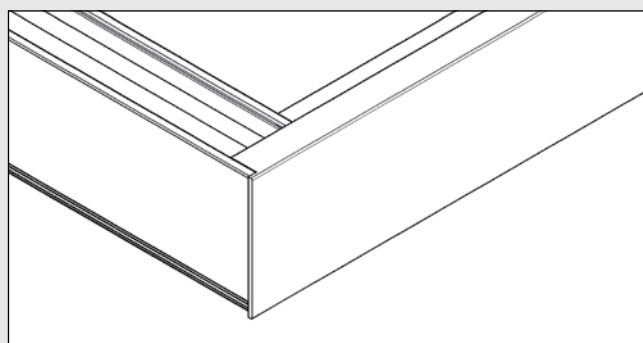



## Aluminium support-profile connector

For support-profile HKP



**Note**

The profile butt joint is only to be positioned directly above a post or support.

Art. no.	Dimensions [mm] <sup>1)</sup>	Material	PU*
954670	74 x 250 x 50	Aluminium	1

<sup>1)</sup> Height x length x width

\*Incl. 8 drilling screw per connector



**Note**

Can be combined with the Twin system bracket for hidden fastening of deck boards.

## BiGHTY drilling screw

Stainless steel, hardened

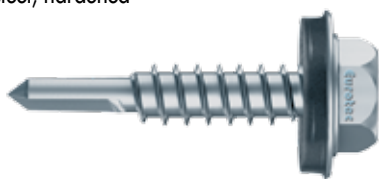

**Suitable for this**



**Stainless Steel**

Art. no.	Dimensions [mm]	Spanner gap	Ø Washer	PU
945666	5,5 x 25	SW 8	Ø 16 mm	500

**Properties**

- For fastening wood to steel or steel to steel
- Special coating
- Stainless steel in accordance with DIN 10088 Washer A2 and EPDM
- Drilling capacity 5 mm

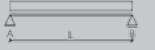
Maximum support distances L [mm] <sup>a)</sup> for supports made of concrete or steel

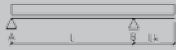
Bearing type	Payload kN/m <sup>2</sup>	Axis clearance e [mm] of support profile HKP to one another <sup>b)</sup>						
		300	350	400	450	500	550	600
Single-span beam L 	2,0	3000	2750	2750	2500	2500	2500	2250
	3,0 <sup>d)</sup>	2750	2500	2500	2250	2250	2250	2000
	4,0 <sup>d)</sup>	2500	2250	2250	2000	2000	2000	2000
	5,0 <sup>d)</sup>	2250	2000	2000	2000	1750	1750	1750
Twin-span beam L [mm] 	2,0	3000	3000	3000	3000	3000	2750	2750
	3,0 <sup>d)</sup>	3000	2750	2500	2500	2500	2500	2250
	4,0 <sup>d)</sup>	2750	2500	2500	2500	2250	2250	2250
	5,0 <sup>d)</sup>	2500	2500	2250	2250	2000	2000	2000
Single-span cantilever beam L [mm] / Lk [mm] 	2,0	3000 / 1000	2750 / 1000	2750 / 1000	2500 / 1000	2500 / 1000	2000 / 1000	1750 / 1000
	3,0 <sup>d)</sup>	2500 / 1000	2500 / 1000	2500 / 750	2500 / 750	2500 / 750	2000 / 750	1750 / 750
	4,0 <sup>d)</sup>	1750 / 1000	1500 / 750	1500 / 750	1500 / 750	1500 / 750	1500 / 750	1500 / 750
	5,0 <sup>d)</sup>	1500 / 750	1500 / 750	1500 / 750	1500 / 750	1500 / 750	1250 / 750	1250 / 750



<sup>a)</sup> Max. bearing clearances (L) for bearings with „direct support“ with payloads of 2, 3, 4 and 5 kN/m<sup>2</sup>, with a mean board thickness of 25 mm and a board weight of 7 kN/m<sup>2</sup>.

<sup>b)</sup> If WPC boards are used, the axis clearance e between the profiles must not exceed 400 mm!

<sup>c)</sup> Payloads in accordance with DIN 1055-3:2006, roof terraces = 4 kN/m<sup>2</sup>, terraces in public = 5 kN/m<sup>2</sup>.

<sup>d)</sup> Load capacity according to SIA 261 for private balconies and roof terraces = 3 kN/m<sup>2</sup>.

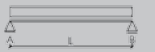
## Maximum support distances (L) for adjustable feet of the PRO-Line (permitted F = 8,0 kN)

Bearing type	Payload kN/m <sup>2</sup>	Maximum support distances L [mm] with the adjustable pedestals of the PRO-Line series with a HKP support profile <sup>a)</sup>						
		300	350	400	450	500	550	600
Single-span beam L 	2,0	3000	2750	2750	2500	2500	2500	2500
	3,0 <sup>a)</sup>	2750	2500	2500	2250	2250	2250	2000
	4,0 <sup>d)</sup>	2500	2250	2250	2000	2000	2000	2000
	5,0 <sup>d)</sup>	2250	2000	2000	2000	1750	1750	1750
Twin-span beam L [mm] 	2,0	3000	3000	3000	3000	3000	2750	2500
	3,0 <sup>a)</sup>	3000	2750	2500	2250	2000	1750	1750
	4,0 <sup>d)</sup>	2500	2250	2000	1750	1500	1250	1250
	5,0 <sup>d)</sup>	2000	1750	1500	1250	1250	1000	1000
Single-span cantilever beam L [mm] / Lk [mm] <sup>d)</sup> 	2,0	3000 / 1000	2750 / 1000	2750 / 1000	2500 / 1000	2500 / 1000	2000 / 1000	1750 / 1000
	3,0 <sup>a)</sup>	2500 / 1000	2500 / 1000	2500 / 750	2500 / 750	2500 / 750	2000 / 750	1750 / 750
	4,0 <sup>d)</sup>	1750 / 1000	1500 / 750	1500 / 750	1500 / 750	1500 / 750	1500 / 750	1500 / 750
	5,0 <sup>d)</sup>	1500 / 750	1500 / 750	1500 / 750	1500 / 750	1250 / 750	1250 / 500	1250 / 500

<sup>a)</sup> Max. bearing clearances (L) for bearings with adjustable pedestals of the PRO-Line series with payloads of 2, 3, 4 and 5 kN/m<sup>2</sup>, with a mean board thickness of 25 mm and a board weight of 7 kN/m<sup>2</sup> (larch, pine, Douglas fir).

<sup>b)</sup> If WPC boards are used, the axis clearance e between the profiles must not exceed 400 mm!

<sup>c)</sup> Load capacities according to DIN EN 1991-1; roof terraces = 4 kN/m<sup>2</sup>, decks for public use = 5 kN/m<sup>2</sup>.

<sup>d)</sup> Lifting forces of up to 1 kN can be sustained on support A.

<sup>e)</sup> Load capacity according to SIA 261 for balconies and roof terraces private use = 3 kN/m<sup>2</sup>.

**Note**

This table provides an overview only of the load bearing capability.

The information on load bearing capability in the technical information must be noted!

# Aluminium function strips / Aluminium function strips DiLo

The aluminium function strips from Eurotec offer special solutions for substructures of timber decks with a low assembly height.

## Properties

- The profile impresses with its low assembly height; for example:  
profile height 29 mm + board 24 mm = Total height 53 mm.
- This low height means the profile is excellently suited to the construction of timber decks that are to be built on existing stone patios, balconies or roof terraces.
- The aluminium is dimensionally stable, does not rust and is extremely weather-resistant. These are key advantages over timber substructures.
- The small supporting surface is ideal for allowing water to run off and prevents the screw from shearing off.
- The self-adhesive cork insert is free of PAHs and ensures good footfall sound damping on the underside of the profile.
- The aluminium function strip is available in two versions so that – here, too – one can choose between visible and hidden screw connections on a case-by-case basis.



Hidden fastening



Visible fastening

## Aluminium function strip



**Free of PAHs**  
(hazardous plasticisers in rubber).

Art. no.	Dimensions [mm] <sup>a)</sup>	Material	PU
945510	29 x 34 x 1750	Aluminium	1

<sup>a)</sup> Height x Width x Profile length

For the direct attachment of decking boards of 21 - 25 mm thickness, see Profile drilling screw and Wing-tipped profile drilling screw (p. 106).



## DiLo aluminium function strip



Holes: 5,1 mm  
Distance from hole to hole: 20 mm  
Distance from edge to first hole: 10 mm

Art. no.	Dimensions [mm] <sup>a)</sup>	Material	PU*
945535	29 x 34 x 2240	Aluminium	1

<sup>a)</sup> Height x Width x Profile length

\*Cork pads are not included with this product.

See DiLo drilling screws (p. 75) for hidden fastening of deck boards with a thickness of 20 - 30 mm.



# Accessories for aluminium function strip / aluminium function strip DiLo

## Procedure for hidden fastening of deck boards to DiLo aluminium function strips:

- 1 Cut the DiLo aluminium function strips and deck boards to the lengths you require.
- 2 Lay the cut boards down so that the rear side is facing upwards.
- 3 Align the boards with a uniform joint spacing on a leveled subsurface. Use the Eurotec spacer for this.
- 4 Lay the DiLo aluminium function strips backwards onto the boards (at least two DiLo aluminium function strips per element).
- 5 Fasten each strip in place by screwing two DiLo drilling screws (Ø5x28,5; Ø5x33,5 or Ø5x38,5 mm) into the board for each intersection point (of board and substructure) through the prefabricated drill holes in the strip.
- 6 Stick the cork pads into the DiLo aluminium function strip so that almost the entire surface is used for support.
- 7 Finally, just turn the finished element over and position it. Done.



## Cork pad with adhesive tape

For DiLo aluminium function strip

**Suitable for this**



Art. no.	Dimensions [mm] <sup>0)</sup>	PU
945331	17 x 90 x 28	100

<sup>0)</sup> Height x length x width



**Pull off the protective film**

## DiLo drilling screw

Hardened stainless steel

**Suitable for this**

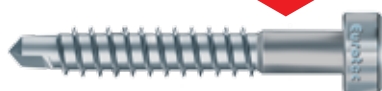

- Limited resistance to acid
- 10 years experience without corrosion problems with suitable woods
- Not suitable for woods containing high amounts of tanning agents, such as cumarú, oak, merbau, robinia, etc.
- Not suitable for use in chlorous atmospheres
- Stainless steel in accordance with DIN 10088

**Stainless Steel**

Art. no.	Dimensions [mm]	Drive	Board thickness	PU*
111860	5,0 x 28,5	TX25 •	at least 20 mm	200
111861	5,0 x 33,5	TX25 •	at least 25 mm	200
111862	5,0 x 38,5	TX25 •	at least 30 mm	200

\* Incl. 1 Bit

## Overview of End Profiles

### End profiles for single point support

- For terraces with flagstone flooring
- Visually attractive border
- Easy assembly
- Water drains through holes in profile

### Terrace edge profile for aluminium substructures

- Aesthetic finish of terraces with flagstone flooring
- Versatile applications
- For slab thicknesses  $\leq 40$  mm

### Aluminium screen

- High quality terrace edge
- Provides the ability to match the entire edge structure
- Easy assembly
- Freely combinable with all standard gutter systems

### End profiles - Eaves

- Screen with integrated water drain
- Available in 2 heights
- Easy assembly
- Freely combinable with all standard gutter systems





## Deck fascia board mount

- Provides a visually pleasing Fascia
- Can be used with the PRO M and L adjustable pedestals



## Fascia profile

- For a head end or the butt joint of the decking
- Ensures non-slip surface even in wet conditions
- Flat geometry prevents tripping hazards
- Resistant to weather, UV exposure, insects and rot



## DrainTec – drainage grate

- For draining façade and terrace surfaces
- Can be combined with the Eurotec product range to create elevated deck areas
- For creating barrier-free, wheelchair-friendly transitions
- Also suitable for direct mounting on load-bearing foundations



# Deck end profiles for single point support

Our deck end profile for single point support can be used to achieve a visually attractive border on decks with stone slab flooring. Our product is used in the field of single point support in conjunction with our PRO M - XL adjustable pedestals.

The border consists of two parts: the upper part, which is placed on the head of the PRO adjustable pedestal, and the lower part, on which the adjustable pedestal is positioned.

## End profiles for single point support



Art. no.	Name	Dimensions [mm] <sup>a)</sup>	Material thickness [mm]	Material	PU
975637	top	37,5 x 215,5 x 2000	3	Aluminium	1
975638	bottom	23 x 240,5 x 2000	3	Aluminium	1

<sup>a)</sup> Height x Width x Profile length

**Note:** for slab thicknesses ≤ 40 mm

During the installation of an outdoor deck in combination with adjustable pedestals as direct supports, we recommend to build a frame around the outer perimeter by using our end profiles for stand alone support, to prevent the covering surface from moving under live-load.



- Advantages**
- Visually attractive border
  - Easy assembly
  - Water drains through holes in profile

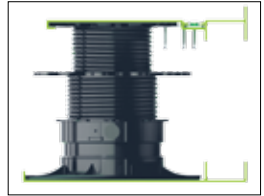

## External corner deck edging set

For external corners in combination with top and bottom end profiles

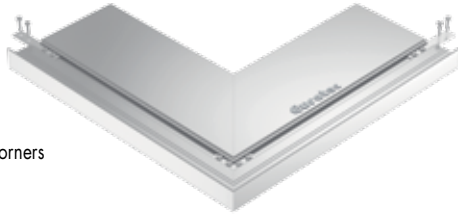

### Set consists of

- Left and right external corners
- 2 profile connectors
- 1 corner connector
- 12 drilling screws 4,8 x 25 mm

Art. no.	Dimensions [mm]	Material	PU
975646	500 x 500	Aluminium	1

## Inside corner deck edging set

For inside corners in combination with end profiles

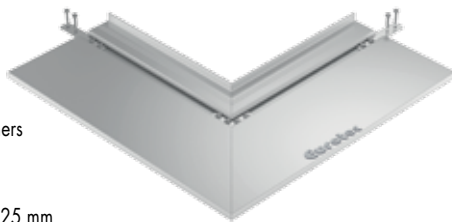

### Set consists of

- Left and right inside corners
- 2 profile connectors
- 1 corner connector
- 12 drilling screws 4,8 x 25 mm

Art. no.	Dimensions [mm]	Material	PU
975645	500 x 500	Aluminium	1

## Corner connector deck edging set

For 90° corner connections in the end profiles



### Set consists of

- 2 corner connectors
- 8 drilling screws 4,8 x 25 mm

Art. no.	Dimensions [mm] <sup>*)</sup>	Material thickness [mm]	Material	PU
975641	50 x 50 x 20	2	Aluminium	2

\*) Height x length x width

## Profile connector deck edging set

For extending the end profiles

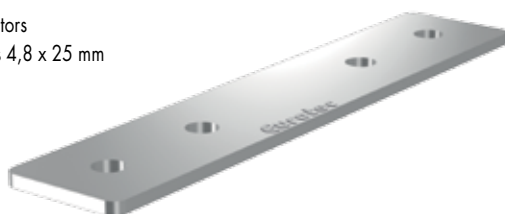

### Set consists of

- 2 profile connectors
- 8 drilling screws 4,8 x 25 mm

Art. no.	Dimensions [mm]	Material thickness [mm]	Material	PU
975642	100 x 20	2	Aluminium	2

# Deck end profile for aluminium substructures

The Eurotec deck end profiles for aluminium substructures deliver a visually attractive border on decks with stone slab flooring in combination with the Profi-Line adjustable pedestals and the EVO aluminium system profile.

The system consists of two end profiles, which enclose the deck's upper and lower edges respectively.

## End profiles for aluminium substructure

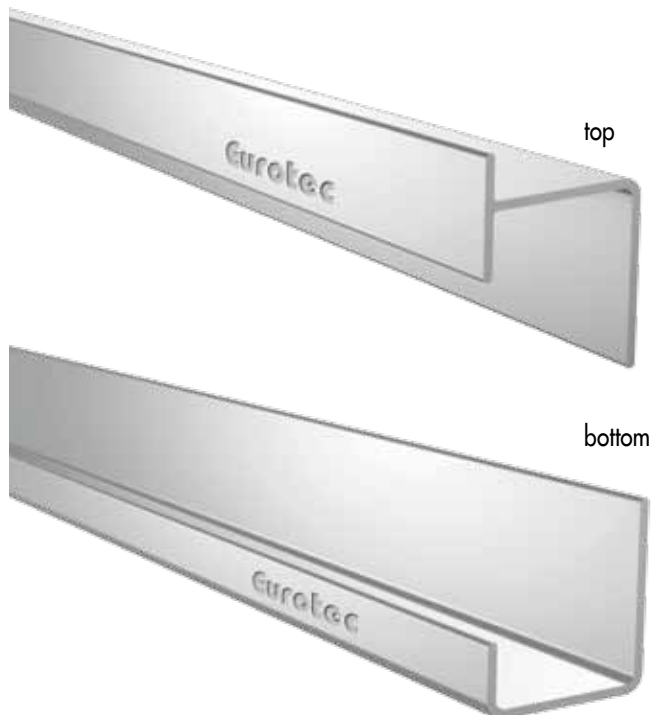

Art. no.	Name	Dimensions [mm] <sup>a)</sup>	Material thickness [mm]	Material	PU
975639	top	61,5 x 45 x 2000	2,5	Aluminium	1
975640	bottom	50 x 45 x 2000	2,5	Aluminium	1

<sup>a)</sup> Height x Width x Profile length

**Note:** for slab thicknesses ≤ 40 mm

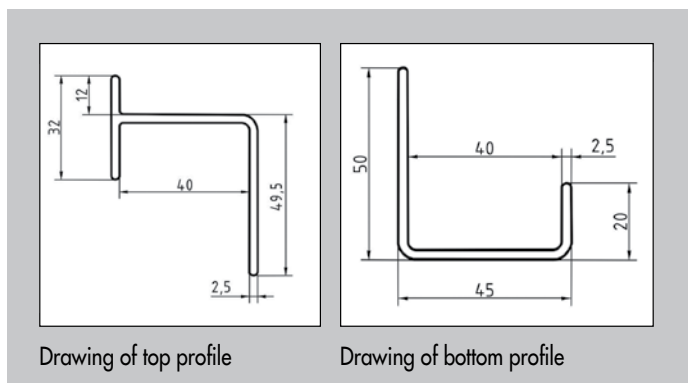

### Advantages

- Visually attractive border
- Versatile applications

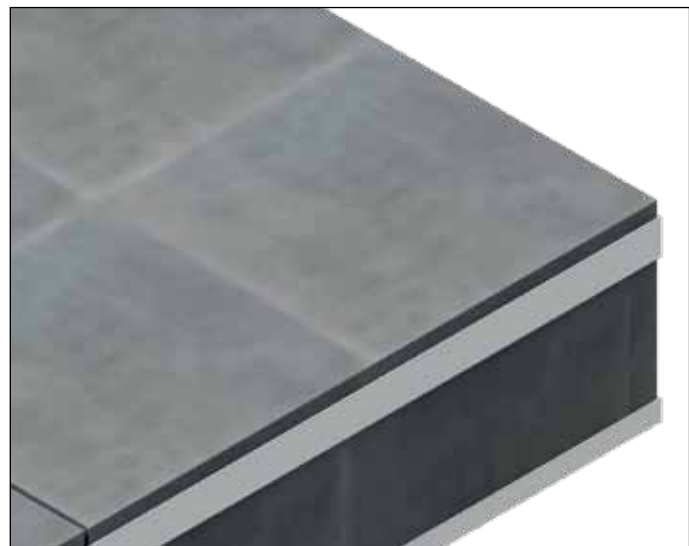



**Notes**

The product only includes the particular aluminium end profiles.  
 All other components must be ordered separately. Per fastening, these include:  
 EVO aluminium system profiles, 90° EVO joint, EVO corner connector and  
 6x BiGHTY 4,8 x 25 mm drilling screws (art. no. 954090-50, PU: 50).

(4x for the 90° EVO joint and 1x each for the connections to the top and bottom deck edging end profiles).

For slab thicknesses of less than 40 mm, the resulting free space must be filled with compression seal tape.



# Aluminium cover

The aluminium cover can be combined with the tops of the terrace edge profiles for an aluminium substructure and single bearing or with the stone-edge clip to a high-quality terrace edge.

## Aluminium cover

Art. no.	Dimensions [mm] <sup>1)</sup>	Material thickness [mm]	Material	PU
975655	116 x 7 x 2000	2	Aluminium	1

<sup>1)</sup> Height x width x length



### Advantages

- Easy assembly
- Flexible border design
- It is possible to match the complete edge structures together
- Can be combined with all standard gutter systems/eaves fascia



# Aluminium eaves

The aluminium eaves offers an additional opportunity to form the terrace edge. It is available in 3 cm and 5 cm in height. The aluminium eaves forms the lower part or the entire panel for smaller

heights. Combined with the aluminium cover, the side openings can be closed.

## Aluminium eaves



### Advantages

- Easy assembly
- Elegant view
- Flexible border design
- It is possible to coordinate the complete edge structure
- Freely combinable with all standard gutter systems
- The lower sheets are enclosed within the sealing
- Integrated water drainage

Art. no.	Name	Dimensions [mm] <sup>1)</sup>	Material thickness [mm]	Material	PU
975653	Aluminium eaves 3 cm	72 x 104 x 2000	1,8	Aluminium	1
975654	Aluminium eaves 5 cm	92,8 x 104 x 2000	1,8	Aluminium	1

<sup>1)</sup> Height x width x length





# Deck fascia board mount / Cover profile

## Deck fascia board mount

Set incl. base plate, side bracket and screws

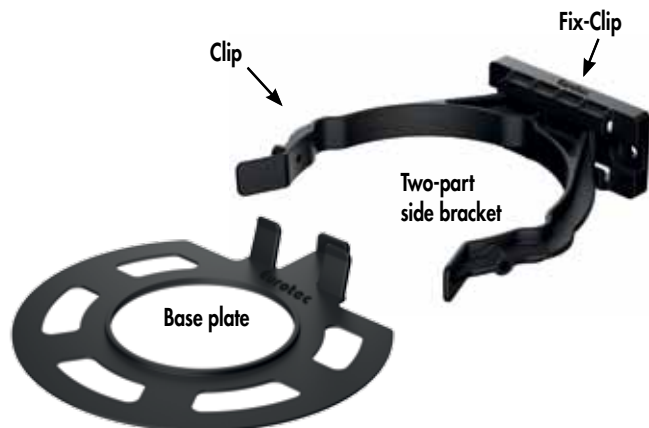

The Eurotec deck fascia board mount can be used with the PRO M and L adjustable pedestals. It was developed to allow users to create a visually attractive border on decking. The deck fascia board mount consists of a base plate and a side bracket. For assembly purposes, the side bracket can be separated into two individual parts: the Clip and the Fix-Clip.

Art. no.	Set consists of	PU*
946068	Base plate and Two-part side bracket	16

\* Delivery includes screws



Example application for mounting of a timber deck fascia using the PRO L adjustable pedestal.

## Cover profile

For edge and end cover of the decking



The area of application of the new cover profile is the head end or the butt joint of the decking. Due to the specific surface, the screen profile is able to guarantee no risk of slipping even in wet conditions. Thanks to the flat geometry, the cover profile does not represent a tripping hazard. Our cover profile can be freely combined with all commercially available decking boards.

Art. no.	Length [mm] <sup>1)</sup>	Material thickness [mm]	PU
975651	27,5 x 37,5 x 2400	2,5	1

<sup>1)</sup> Height x width x length

### Advantages

- Quick and easy assembly
- Freely combinable with all available decking boards
- Ensures a non-slip surface even in wet conditions
- Flat geometry prevents tripping hazards
- Resistant to weather, UV exposure, insects and rot

### Application information

Fixing is done with countersunk screws ( $\varnothing \leq 4$  mm) through the prefabricated holes, which are arranged at an axis-centre distance of 20 cm. Due to the small edge distance of the screw, it is recommended that you pre-drill!



# DrainTec – aluminium drainage grate

The construction of an open-air space is accompanied by an extensive set of requirements.

In developing the DrainTec drainage grate, we turned our attention to the topic of: **drainage for façade and deck surfaces**. The DrainTec drainage grate focuses on the detailed aspects of how these surfaces connect to building openings, e.g. areas that connect to doors, or transitions from vertical façade surfaces to horizontal deck surfaces.

Its special geometry allows it to “trap” the rain so that the water falls directly onto the weatherproof layer, or into the gutter, without covering the door element or the façade cladding with reflected water (backsplash). Heavy rain is drained off in a controlled manner. The flat geometry (21 x 140 mm) allows the grate to be combined with standard deck boards or fine stoneware slabs.

## DrainTec – drainage grate



Art. no.	Name	Dimensions [mm] <sup>a)</sup>	Material	PU
975634	DrainTec – drainage grate	21 x 140 x 4000	Aluminium	1

<sup>a)</sup> Height x width x length

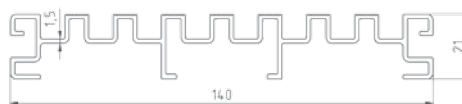

## DrainTec Clip



Art. no.	Name	Dimensions [mm] <sup>a)</sup>	Material	PU*
975635	DrainTec Clip	16,5 x 20 x 144	Stainless steel A2	2

<sup>a)</sup> Height x width x length

\*Comes supplied with screws

Used to attach drainage grate by simply clicking into place and allows subsequent removal of drainage grate.



### Without DrainTec

the reflected rainwater splashes onto the door element or façade cladding



### With DrainTec

the rain is drained off in a controlled manner and the rainwater flows directly into the foundation

The aim is to ensure permanent drainage without dammed-up water.

- Can be combined with the Eurotec product range to create elevated deck areas
- As an inspection and cleaning fitting

- Even for low door-joint heights
- For creating barrier-free, wheelchair-friendly transitions
- Also suitable for direct mounting on load-bearing foundations

# DrainTec Base

The DrainTec Base is the ideal addition to our DrainTec Drainage Grate.

Thanks to the DrainTec Base, our DrainTec Drainage Grate can now also be used at ground level on gravel, sand and other substrates.

Through the angular perforations in the middle of the base, the base can be combined with our adjustable pedestals from the PRO-Line series.

The Click Adapter 60 is required for this. By using an additional screw, the base can be fixed onto the adjustable pedestal. The base can be used as part of standalone support and with aluminium substructures.



Art. no.	Name	Dimensions [mm] <sup>a)</sup>	Material	PU
975658	DrainTec Base	20 x 144 x 2400	Aluminium	1

<sup>a)</sup> Height x width x length

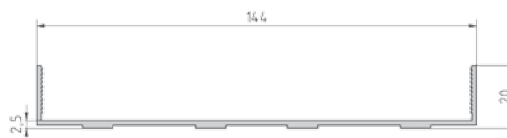

## Advantages

- Supports drainage of decking
- Easy to clean base
- Does not require any additional substructure when laying on bulk material
- Compatible with classic substructures made of wood as well as with our modern aluminium system profile and the deck support system HKP
- Easy to lay
- Weather-resistant
- Compatible with adjustable pedestals PRO S – PRO XL



## Instructions for use

When using on an aluminium substructure we strongly recommend the use of our MaTre band (product no. 945319). This serves to prevent noise when treading on the structure.



**NEW**  
to our product range

# DrainTec Adapter

## DrainTec Adapter



### Product description

The DrainTec Adapter is a special accessory for the DrainTec Base. This permits another stone slab to be laid on the base instead of our DrainTec drainage grid. The adapter is inserted on top of the DrainTec Base and then sits firmly on the profile. The adapter can receive one stone slab or alternatively two stone slabs butted together, with the centre spacers of the adapter providing an even pattern of joints. The width of the stone slab needs to be  $114 \pm 0.5$  mm in order to create a joint on the sides through which water can run off and be drained away in a controlled manner using the DrainTec Base.

### Advantages/Specifications

- Two attachment points enable the adapter to be fixed to the DrainTec Base.
- If DrainTec Base is attached to one of our PRO S - XL adjustable pedestals, the inserted stone slab can be adjusted to the level of the stone slabs of the terrace

Art. no.	Material	Dimensions [mm] <sup>01</sup>	PU
975626	Polypropylene copolymer (PP-C)	17,5 x 40,4 x 140,7	10

<sup>01</sup> Height x width x length

\* For fastening, we recommend using BiGHTY PH drilling screws (954068)  
These are not included in the product.



# Aids

For laying deck boards

## HIDDEN FASTENING

### Fixing the deck without visible screw heads

Deck boards can be fastened in different ways, depending on the type of wood. We provide innovative solutions that enable your individual requirements and wishes for fastening your deck boards.

### Advantages

- Indirect/hidden fastening solution
- Compatible with different Eurotec aluminium system profiles
- Uniform joint spacing is guaranteed
- Supports constructive timber protection
- Weather-resistant



© NATURinFORM

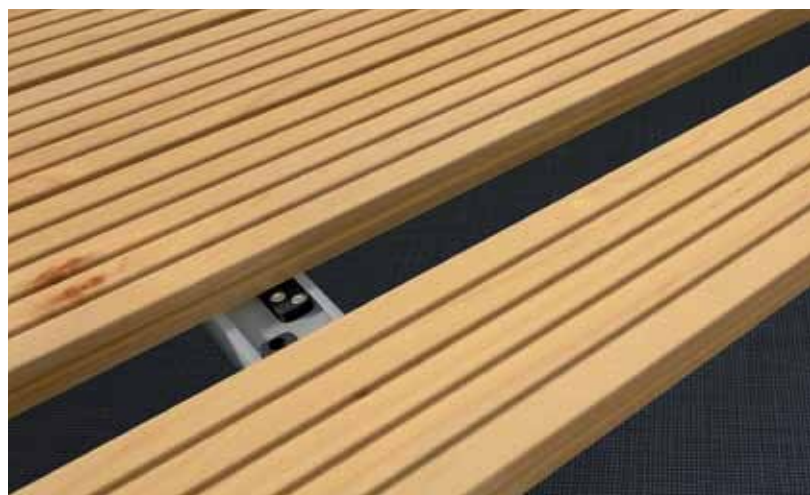

Hidden fastening

# Twin system clip

Hidden fastening to aluminium substructure

## Twin system clip

For hidden fastening of decking with grooved sides and made of dimensionally stable timber types (e.g. larch, thermally modified timber) or WPC to:

- EVO aluminium system profile
- EVO Slim aluminium system profile (please consider the note)
- HKP deck-support system

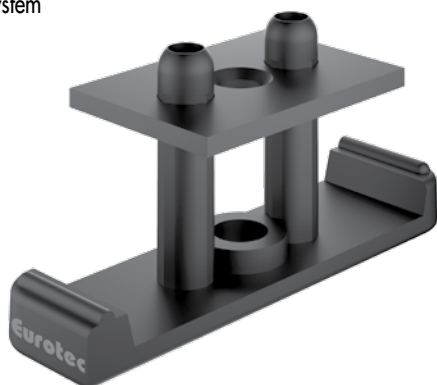

### Product description

The Twin aluminium system clip is inserted between two wooden boards before being secured within the board groove using a stainless steel clamping plate. The clamping plate is attached to the aluminium substructure using a drilling screw between the joints. The spacer domes ensure uniform joint spacing from board to board.

### Advantages

- Indirect/hidden fastening solution
- Individual boards can be adjusted and replaced at any time
- Compatible with Eurotec's EVO/EVO Slim aluminium system profiles and the HKP deck-support system
- Uniform joint spacing of approx. 6 mm
- Supports constructive timber protection
- Weather-resistant

Art. no.	Dimensions [mm] <sup>a)</sup>	Material	PU*
945959	26 x 55 x 15	Plastic, black	200

clamping plate	2 x 30 x 20,5	A2 stainless steel, black
----------------	---------------	---------------------------

<sup>a)</sup> Height x length x width

\* Comes supplied with screw Ø 5 x 50 mm and bit



The Twin system clip is suitable for boards with the following groove geometry:

Groove depth, D:	Groove width, W:	Groove wall thickness, T:
≥ 7,5 mm	≥ 2,0 mm	≥ 2,0 – 12,0 mm

Where applicable, the manufacturer/timber supplier must establish whether the timber type is suitable.

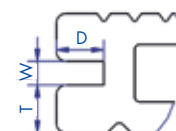

### Alternative screw for the use of the EVO Slim profile:

Art. no.	Dimensions [mm] <sup>a)</sup>	Material	PU
111882	5 x 30	Stainless steel, hardened	100
111878	5 x 35	Stainless steel, hardened	100

<sup>a)</sup> Height x width

### Note:

If the Twin system clip is intended to be used in combination with the **Aluminium System Profile EVO Slim**, a shorter screw needs to be ordered separately. When the supplied screw Ø 5 x 50 mm is used there is the risk, that components below the EVO Slim, such as waterproofings, may get damaged.

It is necessary to take a look at our product data sheet available on [www.eurotec.team](http://www.eurotec.team) or to get in contact with our technical support.

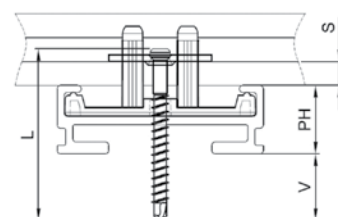



# EVO Light system clip

Hidden fastening to aluminium substructure

## Properties

- For invisible attachment of grooved boards on: EVO Light aluminium system profile
- Suitable for specific groove geometry: See previous page
- For questions regarding groove geometry, always contact your local specialist timber dealer
- Time-saving and easy installation
- Automatically predefined joint spacing of 6 mm
- Individual boards can be adjusted or replaced at any time
- Supports constructive timber protection
- Weather-resistant



Hidden fastening with the EVO Light system clip

## EVO Light system clip

Straight

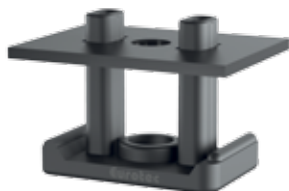

EVO Light system clip, straight is suitable for boards with the following groove geometry:

Groove depth, D:	Groove width, W:	Groove wall thickness, T:
≥ 7,5 mm	≥ 2,0 mm	≥ 2,0 - 9,0 mm

Where applicable, the manufacturer/timber supplier must establish whether the timber type is suitable.

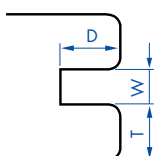

## EVO Light system clip

Bent



EVO Light system clip, bent is suitable for boards with the following groove geometry:

Groove depth, D:	Groove width, W:	Groove wall thickness, T:
≥ 7,5 mm	≥ 4,0 mm	≥ 2,0 - 9,0 mm

Where applicable, the manufacturer/timber supplier must establish whether the timber type is suitable.

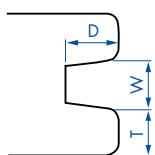

Art. no.	Dimensions [mm] <sup>a)</sup>	Material	PU*
946029	21 x 24 x 15	Plastic, black	200
clamping plate	1,5 x 30 x 22	A2 stainless steel	

<sup>a)</sup> Height x length x width

\* Comes supplied with screw



## Note

In case of deviations of the groove thickness, the screw length may change! Please contact our technical department.

Art. no.	Dimensions [mm] <sup>a)</sup>	Material	PU*
946034	21 x 24 x 15	Plastic, black	200
clamping plate	1,5 x 30 x 21,1	A2 stainless steel	

<sup>a)</sup> Height x length x width

\* Comes supplied with screw



## Note

In case of deviations of the groove thickness, the screw length may change! Please contact our technical department.

# ECO system clip

Hidden fastening to aluminium substructure



© NATURinFORM

## ECO system clip

For Evenco aluminium system profiles

### Properties

- For hidden fastening of boards with grooved sides
- Only limited suitability for selected narrow tropical timbers (always consult your local specialist timber dealer)
- Simple, time-saving assembly
- Joint spacing automatically predefined
- Individual boards can be adjusted or replaced at any time

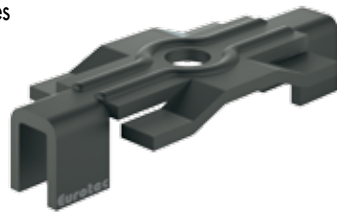

Art. no.	Dimensions [mm] <sup>1)</sup>	Material	PU*
975600-250	7,2 x 37 x 16	Stainless steel, black	250

<sup>1)</sup> Height x length x width

\* Comes supplied with screw



The ECO system clip is suitable for boards with the following groove geometry:

Groove depth, D:	Groove width, W:	Groove wall thickness, T:
≥ 5,5 mm	≥ 2,8 mm	≥ 5,0 - 7 mm

Where applicable, the manufacturer/timber supplier must establish whether the timber type is suitable.

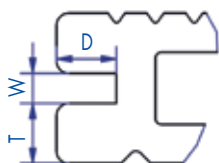



# Deck gliders

## Hidden fastening of deck boards

The deck glider also creates a 10 mm gap between the substructure and the deck boards to prevent shearing of the stainless steel screws, for use with low-swelling and low-shrinkage timbers (see p. 105).

However, in contrast to Distance strips 2.0, the boards are fastened indirectly, i.e. screw heads cannot be seen on the surface of the deck. The gliders fulfill all criteria for fastening both wood and composite boards.



The deck glider comes supplied with Thermofix screws made of hardened stainless steel. If required, you can additionally buy the glider screws in A2 or A4 stainless steel.

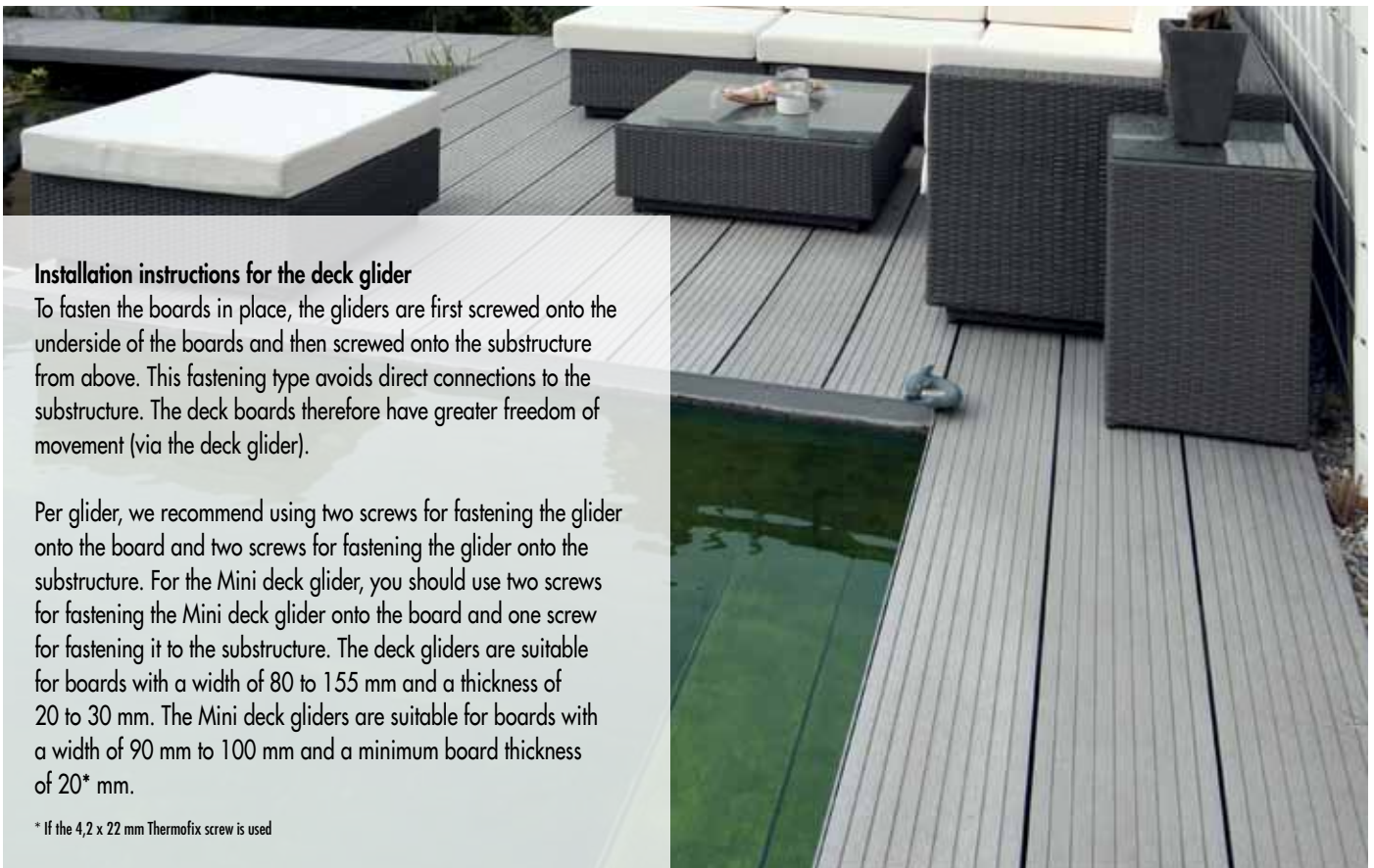

### Installation instructions for the deck glider

To fasten the boards in place, the gliders are first screwed onto the underside of the boards and then screwed onto the substructure from above. This fastening type avoids direct connections to the substructure. The deck boards therefore have greater freedom of movement (via the deck glider).

Per glider, we recommend using two screws for fastening the glider onto the board and two screws for fastening the glider onto the substructure. For the Mini deck glider, you should use two screws for fastening the Mini deck glider onto the board and one screw for fastening it to the substructure. The deck gliders are suitable for boards with a width of 80 to 155 mm and a thickness of 20 to 30 mm. The Mini deck gliders are suitable for boards with a width of 90 mm to 100 mm and a minimum board thickness of 20\* mm.

\* If the 4,2 x 22 mm Thermofix screw is used



## Deck gliders

Suitable for hidden deck-board fastening



Art. no.	Dimensions [mm] <sup>a)</sup>	Quantity* [piece / 10 m <sup>2</sup> ]	Material	PU
944830	10 x 190 x 20	123	Hard plastic	200

<sup>a)</sup> Height x length x width

\* Clearance of bearing beams = 600 mm, board width = 145 mm, Joint dimension = 5 mm (depending on type of timber). Please use decking multi angles or the StarterClip for the first and last bearing beams, and for the board butts.

Each deck glider includes 4 Thermofix screws made of hardened stainless steel. If required, you can additionally buy the glider screws in A2 or A4 stainless steel.

## Mini deck glider

Suitable for hidden deck-board fastening

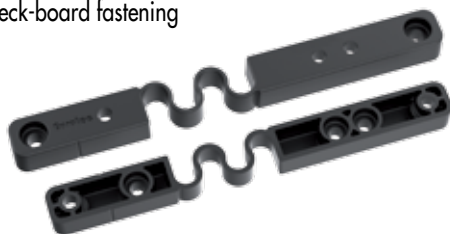

The Mini deck glider is used for narrow deck boards with a width of 90 to 100 mm.

Art. no.	Dimensions [mm] <sup>a)</sup>	Quantity* [piece / 10 m <sup>2</sup> ]	Material	PU
944767	10 x 140 x 14	200	Hard plastic	200

<sup>a)</sup> Height x length x width

\* Clearance of bearing beams = 500 mm, board width = 90-100 mm, Joint dimension = 5 mm (depending on type of timber). Please use decking multi angles or the StarterClip for the first and last bearing beams, and for the board butts.

Each Mini deck glider includes 3 Thermofix screws made of hardened stainless steel. If required, you can additionally buy the glider screws in A2 or A4 stainless steel.

## Glider screw

A4



- Limited resistance to acid
- Suitable for use with woods containing tanning agents such as cumarú, oak, merbau, robinia, etc.
- Suitable for saline atmospheres
- Not suitable for use in chlorous atmospheres

Stainless Steel

Art. no.	Dimensions [mm]	Drive	PU
944927	4,2 x 24	TX20 ●	100

## Thermofix screw

With drill point, stainless steel, hardened

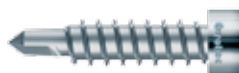

Stainless Steel

Art. no.	Dimensions [mm]	Drive	PU
945969	4,2 x 22	TX20 ●	100

# Decking multi angles

Hidden screwing of start/end deck boards

## Decking multi angles

For hidden fastening of start/end deck boards



Art. no.	Material	PU*
975584	Hard plastic	10

\*40 system screws are included in the scope of delivery

If you would like to fix the start/end decking without a visible screw, use the decking multi angle or the StarterClip.

Decking multi angles enable a clean and hidden conclusion when deck boards are laid.



# StarterClip

Hidden screwing of start / end deck boards

## StarterClip

For hidden fastening of start/end deck boards

Art. no.	Material	PU*
975591	Hard plastic	10

\*40 system screws are included in the scope of delivery



If decking multi angles cannot be used, e.g. because they cannot be screwed in from one side (house wall or brickwork), Eurotec has developed the StarterClip, which is the ideal solution in situations like this.

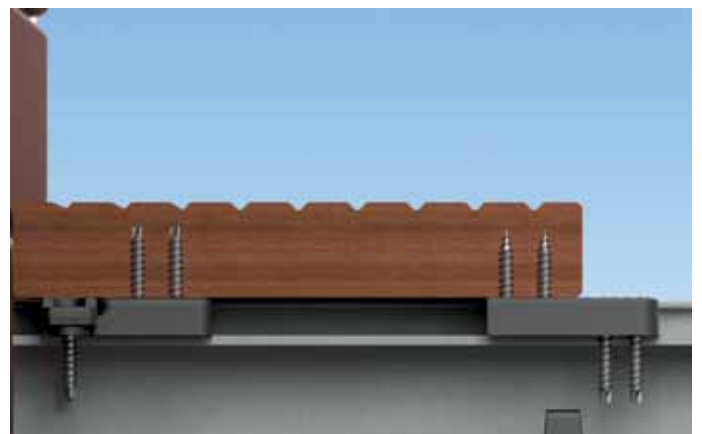
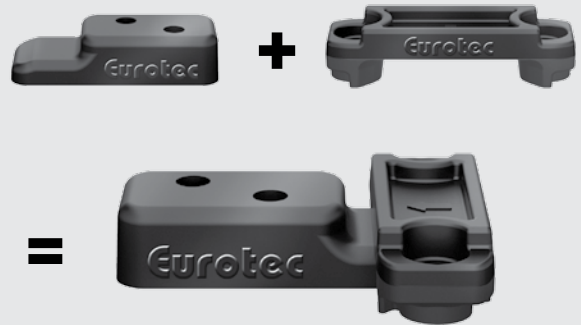



# T-Stick

## Hidden fastening of deck boards

The T-Stick is inserted between two wood boards and fastened in the board groove with a steel plate. The result is an attractive wood surface without visible screw heads. The board clearance is maintained automatically by the T-Stick. The clearance of 9 mm to the substructure enables good ventilation, and this prevents waterlogging. The service life is therefore affected positively. If Eurotec's installation specifications are complied with, the T-Stick enables the boards to be adjusted easily before they are screwed down firmly. After fastening, the boards are absolutely firm. If a board has to be replaced, the system makes this possible even after the deck has been completed.

### Fast installation

The T-Stick fastening system can be used immediately. Using the StarterClip allows hidden screw connections even for the start and end boards. No pilot drilling is needed.

Once the start board has been laid, the next board is put into position, aligned and fixed. Insert the T-Stick with the plate into the wood board groove, screw the screw in slightly to fix. After fixing the board, you can screw it in place.

Make sure that your cordless screwdriver's torque is set correctly so that you never over-tighten the screws.

## T-Stick

### Advantages

- Boards can be replaced easily even after the deck has been completed!
- Realigning individual boards is possible at any time.
- When they are fixed, the boards have a safe and firm seat.

### Note

Only suitable for dimensionally stable timbers and WPC.

### Material description

The T-Stick comprises a glass fibre reinforced, weather-resistant plastic cross with a stainless steel plate and a stainless steel screw.

### There are two design variants:

- 1) **Stainless steel A2 plate** for normal external use.
- 2) **Stainless steel A4 plate** for chlorous and saline atmospheres (e.g. seawater) and in woods with increased tanning acid content (e.g. Robinia, oak).

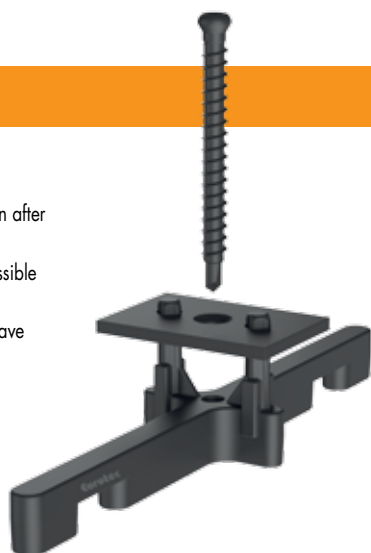

Art. no.	Stainless steel plate*	Material	PU**
111857	A2	Plastic, black	125

\* Stainless steel A4 plate available on request.

\*\* Supplied with a drilling screw, which is suitable for wooden and aluminium substructures with a thickness of up to 3 mm.

### The T-stick is suitable for planks with the following groove geometry:

Groove depth, D:	Groove width, W:	Groove wall thickness, T:
≥ 7,5 mm	≥ 2,5 mm	≥ 5,5 – 12,5 mm

Where applicable, the manufacturer/timber supplier must establish whether the timber type is suitable.

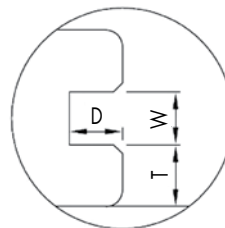

## Using the T-Stick

### A wood deck without visible screw heads!



Start with the decking multi angle or StarterClip.



Align and fix the next board, screw down with the T-Stick until all boards are fastened.

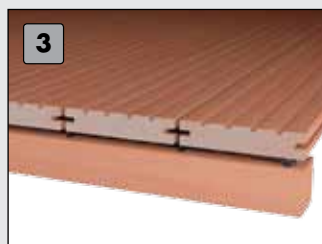

The last board can then be fastened with the StarterClip.



**This fastening system is suitable exclusively for deck boards with a side groove.**

# Drill Tool 50X

The optimal screw-in aid

The drill tool 50X is a drilling jig for the invisible attachment of decking. Decking boards can only be fastened non-visibly with this tool. Thus, no screw heads are visible on the terrace surface.

The screws are evenly screwed in at a 50 ° angle thanks to the specified fixing points and thus optimally placed.

The distance done on the drill tool 50X automatically ensures a uniform gap distance of 6 mm between the individual planks.



## Drill Tool 50X



### Advantages

- Quick and easy decking installation
- Ensures a uniform joint pattern
- Fixing points are predefined

### Instructions for use

With the help of the drill tool 50X decking can be non-visibly fixed.

For optimal installation without damaging the decking we recommend our 50X deck screw in A2 4,2 mm x 60 mm, 50X long-bit 82 mm TX15 and the 50X step drill 3,3 mm to 4,5 mm.

For decking thicknesses  $\geq 21$  mm and decking widths of 110 mm - 150 mm.

Important: You need to ask the manufacturer or supplier whether the board is suitable for this type of attachment.

Art. no.	Dimensions [mm] <sup>1)</sup>	PU
499985	87 x 215 x 30	1

<sup>1)</sup> Height x length x width

## 50X deck screw

Stainless Steel



Art. no.	Dimensions [mm]	Material	PU
905514	4,2 x 60	Stainless steel A2	250
100250	4,2 x 60	Stainless steel A4	250

## 50X long-bit

82 mm



Art. no.	Size	PU
499985-Bit	TX15 •	1

## 50X step drill



Art. no.	Material	PU
499985-Bohrer	Carbide	1



# Eurotec Basic Shop

Everything at a glance



The Basic Shop is the cost-effective and space-saving alternative for selling the Eurotec 50X drill tool products.

## Equipped with

- 50X deck screw
- 50X step drill
- 50X long bits
- 50X drill tool

## The shelf has the following dimensions:

Height 1750 mm, width 338 mm, depth 500 mm

# V-Clip

Hidden fastening of deck boards

## V-Clip



Art. no.	Dimensions [mm] <sup>a)</sup>	Material	PU*
111885	32,3 x 22,7 x 9,4	Stainless steel A2	250

a) Length x width x height

\* Comes supplied with screw Ø 4,2 x 25 mm and 1 Bit/PU

The V-Clip is suitable for planks with the following groove geometry:

Groove depth:	Groove width:	Groove wall thickness:
≥ 8,2 mm	≥ 2,5 mm	≥ 8,0 - 10,0 mm

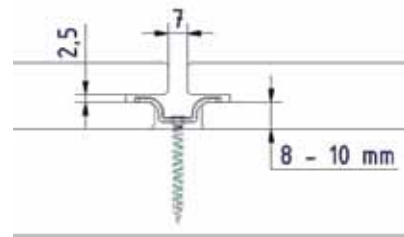

### Advantages

- Indirect/hidden fastening solution
- Compatible with classic substructures made of wood as well as aluminium
- Uniform joint spacing of 7 mm

### Note

Only suitable for the fastening of asymmetric grooved decking made of dimensionally stable timber types or WPC.

The stainless steel Eurotec V-Clip is suitable for the fastening of asymmetric grooved decking made of dimensionally stable timber types or WPC on timber substructures.

Make sure that your cordless screwdriver's torque is set correctly so that you never over-tighten the screws.

## Using the V-Clip

A wooden terrace without visible screw heads!

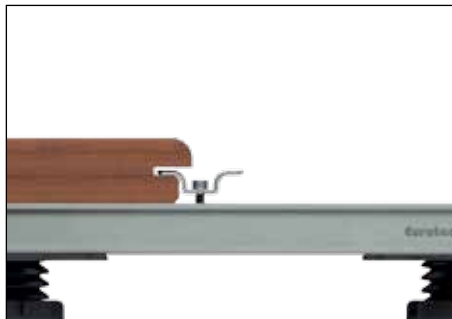

**NEW**  
to our product range

# Decking Clip

Hidden fastening of deck boards

The Eurotec Decking Clip is ideal for concealed fastening of grooved decking boards made of wood or WPC onto a wooden substructure. The clip is fastened in the groove between two individual boards. The boards are fastened with screws at an angle of 45°.

The inclined screw connection avoids tearing or shearing off of the screws during swelling and shrinkage movements. Delivery includes, in addition to the decking clip, screws, a matching TX15 bit and a 3 mm drill for pre-drilling the boards.

## Decking Clip

### Advantages / Properties

- Concealed fastening of the decking boards
- Can be used in combination with a classic wooden substructure
- Uniform board spacing is guaranteed
- Weather-resistant
- 45° fastening prevents breakage or shearing of screws

Art. no.	Dimensions [mm] <sup>a)</sup>	Material	Included in the scope of delivery	PU
975636-175	46 x 25,4 x 9,8	Stainless steel	1 x drill Ø 3 mm, DIN338, Art. no. 4903-001 1 x bit 50 mm, TX15, Art. no. 500049 1 x Trim Head Wood, TX15, 4,0 x 57 mm, Art. no. 905830	175
975636-525	46 x 25,4 x 9,8	Stainless steel	2 x drill Ø 3 mm, DIN338, Art. no. 4903-001 2 x bit 50 mm, TX15, Art. no. 500049 2 x Trim Head Wood, TX15, 4,0 x 57 mm, Art. no. 905830	525

<sup>a)</sup> Length x width x height

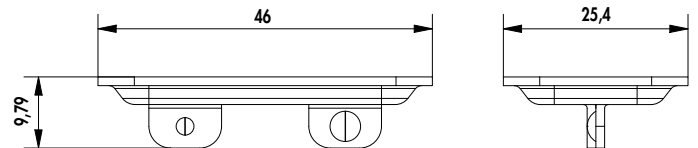

Included in the scope of delivery

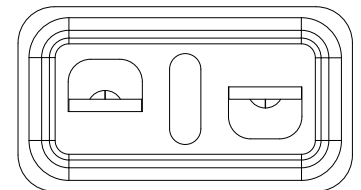

## Using the Decking Clip

A wooden terrace without visible screw heads!



1 Place the first decking board at the correct distance to the house and drill on the outer edge. The decking boards can be attached to the wooden substructure.



2 Place the Eurotec Decking Clip on the substructure and pre-drill the lower leg of the pre-grooved decking board at a 45° angle. Use the 3 mm drill supplied.



3 Attach the decking clip to the pre-drilled position by feeding the screw through the decking clip. Repeat the same process for each board at each position of the bar.



4 There are lots of installation options for the final decking board. Note that the final decking board must be fastened to the outer edge with a head screw.

### Recommendation:

Mount the screws ideally at the joints of two boards to reduce wood movement to a minimum.

The Eurotec Decking Clip prevents individual boards from shifting or becoming loose.

The screws act as additional fastening to guarantee the longevity of the whole terrace.

In order to conceal screw heads, it is possible to purchase matching crossbar plates on request (not included in the scope of delivery).







## Accessories

For decking installation

# VISIBLE FASTENING

### Fixing the decking with visible screw heads

Deck boards can be fastened in different ways, depending on the type of wood. We provide innovative solutions that enable your individual requirements and wishes for fastening your deck boards.

### Advantages

- Direct/visible fastening solution
- Easy, fast laying of the decking
- Compatible with different Eurotec aluminium system profiles
- Easy replacement of individual decking boards
- Supports constructive timber protection
- Weather-resistant

© NATURinFORM

# Distance strip 2.0

Visible fastening of deck boards

## Substructure: Timber

The wooden decking board substructure is individually suitable for visible or invisible attachments of the decking boards. Distance strip 2.0 is very well suited for visible attachments of decking boards. It works as a spacer and allows freedom of movement between panel and substructure.

At the same time, it benefits the air circulation. Standard wood screws,

such as Terrasotec screws, are used for the screw connection of a wood substructure.

Distance strip 2.0 reduces the risk of sheared off screws.

**Important:** Hardwoods/tropical woods should always be pilot-drilled!

## Distance strip 2.0

For the secure attachment of decking boards.



Distance strip 2.0 is attached and fixed with Terrasotec screws Ø 4 mm in the holes provided (5 Terrasotec screws are required for one Distance strip 2.0). Distance strip 2.0 is 70 cm long.

Art. no.	Dimensions [mm] <sup>1)</sup>	Material	PU*
944803	30 x 700 x 7	Hard plastic	50

<sup>1)</sup> Width x length x height

\* Screws are not included.  
Fastening with Terrasotec screws Ø 4 mm.





### Distance strip 2.0 reduces the risk of sheared off screws

Distance strip 2.0 is made of hard plastic and is intended to prevent the stainless steel screws from shearing off. The shearing is caused by the swelling and shrinking of the wood, the so-called working of the wood. This working of the wood is especially pronounced in the transverse direction of the boards. The wood „wants“ to take the screw with it, while the lower part of the screw is still firmly seated in the substructure. Since hard and tropical wood is very hard due to its very high density, the screw does not have a chance of pressing into the wood if the wood is working. If the screw breaks off due to this stress, this is called shearing off. Distance strip 2.0 was developed in order to prevent stainless steel screws from shearing off. It creates a freedom of movement of 7 mm between substructure and decking boards, which gives the stainless steel screws the opportunity to move together with the wood.

#### What does „shearing off“ mean?

A screw can shear off (tear off) when it does not have enough freedom of movement while the wood is swelling and shrinking. With the help of Distance strip 2.0, a distance of 7 mm is achieved between the board and substructure, which allows the screws to adjust to the movements of the wood. In this way, shearing off is prevented.

### Schematic representation »shearing«

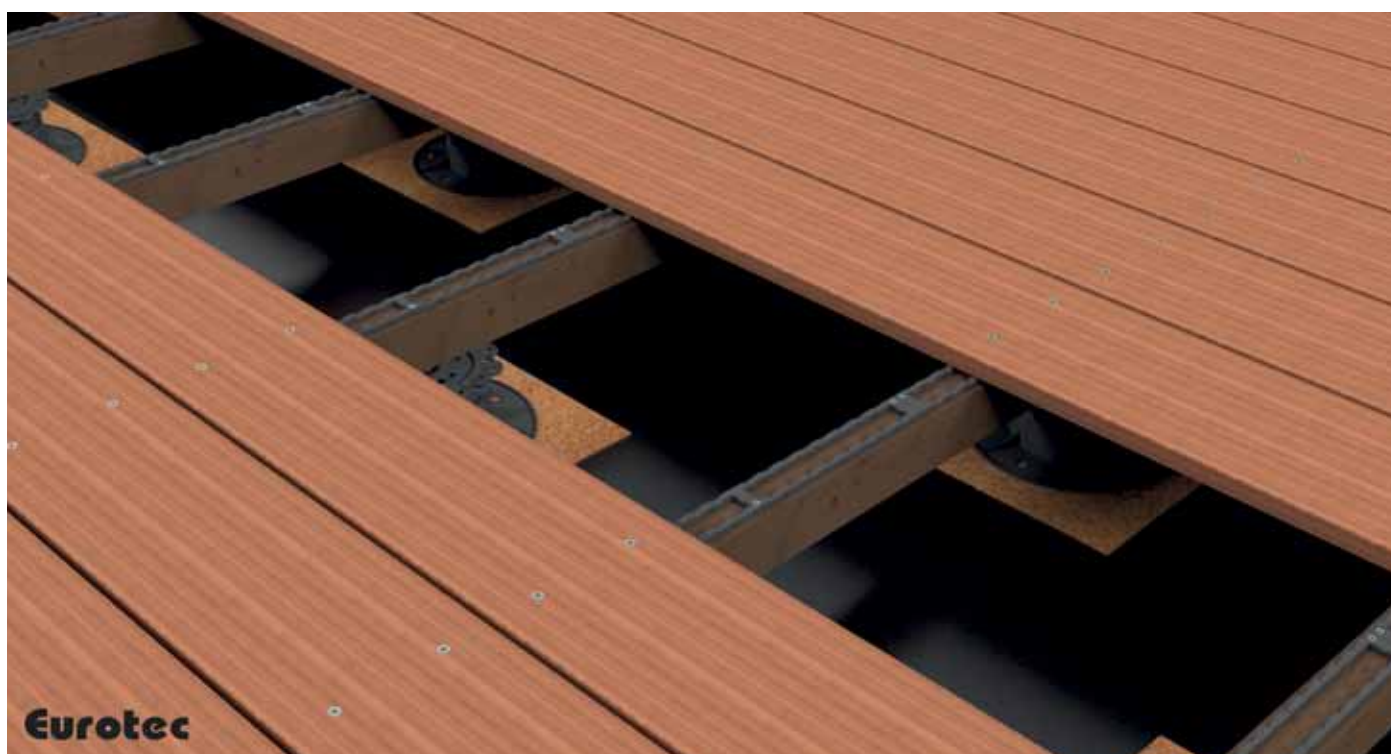
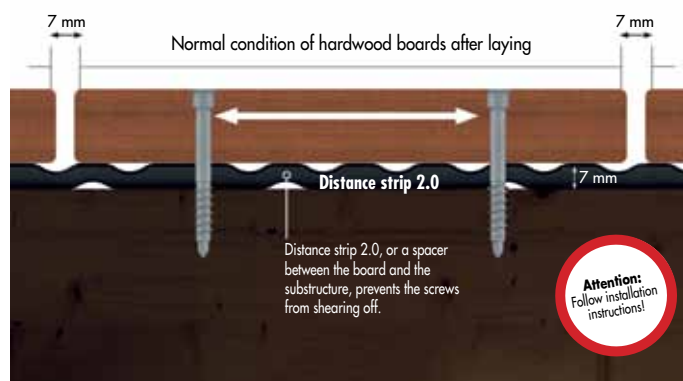

# Profile drilling screw / Wing-tipped profile drilling screw



The profile drilling screws are suitable for the visible fixing of decking on the **Eurotec aluminium profiles, aluminium system profile EVO, EVO Light, HKP support profile and aluminium function strip.**



Visible fastening by means of a profile drill screw on an aluminium EVO system profile

## Profile drilling screw

Hardened stainless steel

**Stainless Steel**



- Limited resistance to acid
- 10 years experience without corrosion problems with suitable woods
- Not suitable for woods containing high amounts of tanning agents, such as cumarú, oak, merbau, robinia, etc.
- Not suitable for use in chlorous atmospheres
- Stainless steel in accordance with DIN 10088

Art. no.	Dimensions [mm]	Drive	Board thickness [mm]	PU
905553	5,5 x 41	TX25 •	16 - 20	200
905559	5,5 x 46	TX25 •	21 - 25	200
905562	5,5 x 51	TX25 •	26 - 30	200
975797	5,5 x 56	TX25 •	30 - 36	200
905560	5,5 x 61	TX25 •	36 - 40	200



Suitable for this:  
Drill-Stop for Profile  
drilling screw  
Art. no.: 945606

## Profile drilling screw

Stainless steel A4

**Stainless Steel**



- Limited resistance to acid
- Suitable for use with woods containing tanning agents such as cumarú, oak, merbau, robinia, etc.
- Suitable for saline atmospheres
- Not suitable for use in chlorous atmospheres

Art. no.	Dimensions [mm]	Drive	Board thickness [mm]	PU
905571	5,5 x 41	TX25 •	16 - 20	200
905563	5,5 x 46	TX25 •	21 - 25	200
905564	5,5 x 51	TX25 •	26 - 30	200
975798	5,5 x 56	TX25 •	30 - 36	200
905565	5,5 x 61	TX25 •	36 - 40	200



Suitable for this:  
Drill-Stop for Profile  
drilling screw  
Art. no.: 945606

**Note** The board should always be pilot-drilled to a diameter of 5,5 mm.

## Wing-tipped profile drilling screw

Hardened stainless steel

**Stainless Steel**



- Limited resistance to acid
- 10 years experience without corrosion problems with suitable woods
- Not suitable for woods containing high amounts of tanning agents, such as cumarú, oak, merbau, robinia, etc.
- Not suitable for use in chlorous atmospheres
- Stainless steel in accordance with DIN 10088

Art. no.	Dimensions [mm]	Drive	Board thickness [mm]	PU
905568	5,0 x 55	TX20 •	20 - 25	200
905569	5,0 x 60	TX20 •	26 - 30	200
905570	5,0 x 70	TX20 •	35 - 40	200

### Special feature

- Screws in quickly without pilot drilling

Please refer to the information we provide on "Selecting screw steels" (p. 18), as not all timber types should be installed with hardened stainless-steel screws.



## Terrassotec Trilobular / Terrassotec / Tri-Deck-Tec



Which  
screw steel for  
which timber?  
Please refer to p. 18

### Advantages of Terrassotec Trilobular

#### Special screw geometry

- Drive thread ensures quick screwing
- Reinforced shank reduces risk of breaking or shearing off
- Under-head thread provides additional hold for deck boards

#### Trilobular base geometry

- Reduced installation torque
- Reduced risk of screw breaking during screwing



#### Two-step head with under-head tothing

- Reduced splintering
- Reduced risk of timber splitting



#### Reinforced shank

- Suitable for many tropical woods
- Reduced risk of screw shearing off

### Advantages of Terrassotec

- Reduced splintering through special head
- With self-milling ribs for sinking easily in all wood types
- The screw geometry reduces the danger of splitting, but pilot drilling is recommended in particular for hardwoods and in deck and façade construction!

Check the information from the board manufacturer.



On request, screw heads can be painted in RAL Colours



# Terrassotec Trilobular



## Terrassotec Trilobular

Hardened stainless steel



Stainless Steel



- Limited resistance to acid
- 10 years experience without corrosion problems with suitable woods
- Not suitable for woods containing high amounts of tanning agents, such as cumaru, oak, merbau, robinia, etc.
- Not suitable for use in chlorous atmospheres
- Stainless steel in accordance with DIN 10088

Art. no.	Dimensions [mm]	Drive	PU
905530	5,5 x 50	TX25 ●	200
905529	5,5 x 60	TX25 ●	200
905531	5,5 x 70	TX25 ●	200
905538	5,5 x 80	TX25 ●	200
905545	5,5 x 90	TX25 ●	200
905546	5,5 x 100	TX25 ●	200
905530-EIMER	5,5 x 50	TX25 ●	500
905529-EIMER	5,5 x 60	TX25 ●	500
905531-EIMER	5,5 x 70	TX25 ●	500
905538-EIMER	5,5 x 80	TX25 ●	500
905545-EIMER	5,5 x 90	TX25 ●	500
905546-EIMER	5,5 x 100	TX25 ●	500

## Terrassotec Trilobular

Stainless steel A2



Stainless Steel



- Limited resistance to acid, relatively soft
- Not suitable for use in chlorous atmospheres

Art. no.	Dimensions [mm]	Drive	PU
905539	5,5 x 50	TX25 ●	200
905540	5,5 x 60	TX25 ●	200
905541	5,5 x 70	TX25 ●	200
905542	5,5 x 80	TX25 ●	200
905539-EIMER	5,5 x 50	TX25 ●	500
905540-EIMER	5,5 x 60	TX25 ●	500
905541-EIMER	5,5 x 70	TX25 ●	500
905542-EIMER	5,5 x 80	TX25 ●	500

## Terrassotec Trilobular

Stainless steel A4



Stainless Steel



- Limited resistance to acid
- Suitable for use with woods containing tanning agents such as cumarú, oak, merbau, robinia, etc.
- Suitable for saline atmospheres
- Not suitable for use in chlorous atmospheres

Art. no.	Dimensions [mm]	Drive	PU
905555	5,5 x 50	TX25 ●	100
905556	5,5 x 60	TX25 ●	100
905557	5,5 x 70	TX25 ●	100
905558	5,5 x 80	TX25 ●	100
905547*	5,5 x 90	TX25 ●	100
905548	5,5 x 100	TX25 ●	100
905555-EIMER	5,5 x 50	TX25 ●	500
905556-EIMER	5,5 x 60	TX25 ●	500
905557-EIMER	5,5 x 70	TX25 ●	500
905558-EIMER	5,5 x 80	TX25 ●	500

\* The previous version will continue to be supplied until the switchover is complete.

## Terrassotec Trilobular

Hardened stainless steel, antique



Stainless Steel



- Limited resistance to acid
- 10 years experience without corrosion problems with suitable woods
- Not suitable for woods containing high amounts of tanning agents, such as cumarú, oak, merbau, robinia, etc.
- Not suitable for use in chlorous atmospheres
- Stainless steel in accordance with DIN 10088

Art. no.	Dimensions [mm]	Drive	PU
B905530	5,5 x 50	TX25 ●	200
B905529	5,5 x 60	TX25 ●	200
B905531	5,5 x 70	TX25 ●	200



On request, screw heads can be painted in RAL Colours



Terrassotec

**Terrassotec**

Hardened stainless steel

Can be combined with EPDM façade tape

Stainless Steel



- Limited resistance to acid
- 10 years experience without corrosion problems with suitable woods
- Not suitable for woods containing high amounts of tanning agents, such as cumarú, oak, merbau, robinia, etc.
- Not suitable for use in chlorous atmospheres
- Stainless steel in accordance with DIN 10088
- 50% greater breaking torque than A2 and A4
- Magnetizable

Art. no.	Dimensions [mm]	Drive	PU
905535	4,0 x 40	TX15 ●	500
905536	4,0 x 50	TX15 ●	500
905537	4,0 x 60	TX15 ●	500
945811	4,5 x 40	TX20 ●	200
905528	4,5 x 45	TX20 ●	200
905520	4,5 x 50	TX20 ●	200
905521	4,5 x 60	TX20 ●	200
905522	4,5 x 70	TX20 ●	200
905527	5,0 x 45	TX25 ●	200
905523	5,0 x 50	TX25 ●	200
905524	5,0 x 60	TX25 ●	200
905525	5,0 x 70	TX25 ●	200
905526	5,0 x 80	TX25 ●	200
905544	5,0 x 90	TX25 ●	200
905543	5,0 x 100	TX25 ●	200
905520-EIMER	4,5 x 50	TX20 ●	500
905523-EIMER	5,0 x 50	TX25 ●	500
905524-EIMER	5,0 x 60	TX25 ●	500
905525-EIMER	5,0 x 70	TX25 ●	500
905526-EIMER	5,0 x 80	TX25 ●	500



On request, screw heads can be painted in RAL Colours

**PRACTICAL: Here's everything you need!**

**Terrassotec screws**

Sales unit in bucket with 500 pieces

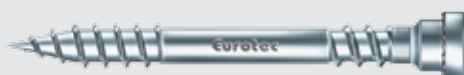

Stainless Steel

incl. Drill-Stop



incl. TX 25 Bit



# Tri-Deck-Tec



With coloured screw heads for WPC decking  
**On request**

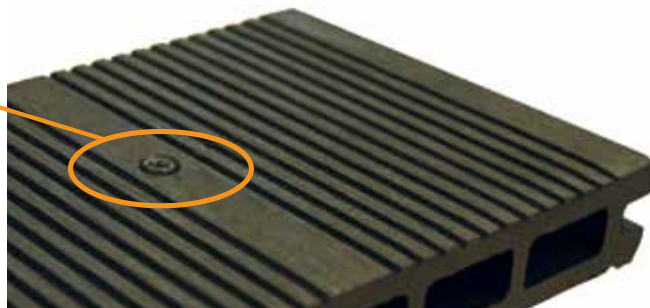

## Tri-Deck-Tec

Hardened stainless steel

**Stainless Steel**



Art. no.	Dimensions [mm]	Colour	Drive	PU
905809	5,0 x 65	Blank	TX20	200
BR905809-EIMER	5,0 x 65	Brown / NCS S 7010-Y50R	TX20	250*
C905809-EIMER	5,0 x 65	Charcoal / NCS 8000-N matt	TX20	250*
CR905809-EIMER	5,0 x 65	Cream / NCS 3010-Y30R matt	TX20	250*
GR905809-EIMER	5,0 x 65	Grey / NCS S5500-N matt	TX20	250*
OAK905809-EIMER	5,0 x 65	Oak / NCS S2050-Y30R matt	TX20	250*
RW905809-EIMER	5,0 x 65	Redwood / NCS 5030-Y50R matt	TX20	250*

\* Supplied in a bucket incl. ECO drill stop and bit TX20.

### Advantages

- Reduced risk of timber splitting
- Drive thread ensures quick screwing
- Under-head thread provides additional hold for deck boards
- Reduced splintering through special head
- Reduction of screw torque due to trilobular basic geometry
- Reduction of the risk of tearing off the screw when screwing through trilobular basic geometry



On request, screw heads can be painted in RAL Colours

## EXPERT HINTS for the construction of wooden terraces

### Wood deck = pilot-drilling

When building a wood deck using premium woods pilot-drilling and pre-counterboring is recommended in all circumstances.

This applies to soft coniferous wood as well as to hardwood.

#### Drill-Stop for:

- Terrassotec Ø 5 und 5,5 mm
- Tri-Deck-Tec Ø 5 mm
- Hapatec Ø 5 mm
- Hapatec Heli Ø 5 mm



The screws can be prevented from shearing through the use of the Distance strip 2.0.



Splintering



Pilot-drilling + Terrassotec screw

### No splintering, no shearing!

By pre-drilling with the Drill-Stop and the especially developed head-shape of the Terrassotec and Tri-Deck-Tec screws, the risk of splintering is greatly reduced.



# Eurotec Basic Shop

Everything at a glance



The Basic Shop is the cost-effective and space-saving alternative for selling the Eurotec Terrasotec trilobular with painted screw heads.

## The shelf has the following dimensions:

Height 1750 mm, width 338 mm, depth 500 mm

# Hapatec screws



## Hapatec

Panel fastener hardwood, stainless steel, hardened



Stainless Steel



- Limited resistance to acid
- 10 years experience without corrosion problems with suitable woods
- Not suitable for woods containing high amounts of tanning agents, such as cumarú, oak, merbau, robinia, etc.
- Not suitable for use in chlorous atmospheres
- Stainless steel in accordance with DIN 10088
- 50% greater breaking torque than A2 and A4
- Magnetizable

Art. no.	Dimensions [mm]	Drive	PU
111803	4,0 x 30	TX15 ●	500
111810	4,0 x 40	TX15 ●	500
111821	4,0 x 45	TX15 ●	500
111811	4,0 x 50	TX15 ●	500
111812	4,0 x 60	TX15 ●	500
904569	4,5 x 45	TX20 ●	200
111813	4,5 x 50	TX20 ●	200
111814	4,5 x 60	TX20 ●	200
111815	4,5 x 70	TX20 ●	200
111816	4,5 x 80	TX20 ●	200
100048	5,0 x 40	TX25 ●	200
100049	5,0 x 45	TX25 ●	200
111817	5,0 x 50	TX25 ●	200
111818	5,0 x 60	TX25 ●	200
111819	5,0 x 70	TX25 ●	200
111820	5,0 x 80	TX25 ●	200
111888	5,0 x 90	TX25 ●	200
111889	5,0 x 100	TX25 ●	200
904569-EIMER	4,5 x 45	TX20 ●	500
111813-EIMER	4,5 x 50	TX20 ●	500
111814-EIMER	4,5 x 60	TX20 ●	500
111815-EIMER	4,5 x 70	TX20 ●	500
111816-EIMER	4,5 x 80	TX20 ●	500
100048-EIMER	5,0 x 40	TX25 ●	500
111817-EIMER	5,0 x 50	TX25 ●	500
111818-EIMER	5,0 x 60	TX25 ●	500
111819-EIMER	5,0 x 70	TX25 ●	500
111820-EIMER	5,0 x 80	TX25 ●	500

## Hapatec »antique«

Panel fastener hardwood, stainless steel, hardened



Stainless Steel



- Limited resistance to acid
- 10 years experience without corrosion problems with suitable woods
- Not suitable for woods containing high amounts of tanning agents, such as cumarú, oak, merbau, robinia, etc.
- Not suitable for use in chlorous atmospheres
- Stainless steel in accordance with DIN 10088
- 50% greater breaking torque than A2 and A4
- Magnetizable

Art. no.	Dimensions [mm]	Drive	PU
B111817	5,0 x 50	TX25 ●	200
B111818	5,0 x 60	TX25 ●	200



On request, screw heads can be painted in RAL Colours

## Hapatec black

Panel fastener hardwood, stainless steel, hardened, black

Stainless Steel



- For fixing black façade boards



Art. no.	Dimensions [mm]	Drive	PU
111802/BLACK	4,0 x 35	TX15 ●	500
111810/BLACK	4,0 x 40	TX15 ●	500
111811/BLACK	4,0 x 50	TX15 ●	500
111812/BLACK	4,0 x 60	TX15 ●	500
111822/BLACK	4,5 x 40	TX20 ●	200
111813/BLACK	4,5 x 50	TX20 ●	200
111814/BLACK	4,5 x 60	TX20 ●	200
111815/BLACK	4,5 x 70	TX20 ●	200
111817/BLACK	5,0 x 50	TX25 ●	200
111818/BLACK	5,0 x 60	TX25 ●	200

## Hapatec Heli

Stainless steel A4

Stainless Steel

Can be combined with EPDM façade tape



- Limited resistance to acid
- Suitable for use with woods containing tanning agents such as cumarú, oak, merbau, robinia, etc.
- Suitable for saline atmospheres
- Not suitable for use in chlorous atmospheres

The special screw geometry reduces the screwing torque. This reduces the danger of the shearing of the relatively soft A4 stainless steel screw.

Art. no.	Dimensions [mm]	Drive	PU
100059	4,5 x 50	TX20 ●	200
100055	4,5 x 60	TX20 ●	200
100056	4,5 x 70	TX20 ●	200
100057	4,5 x 80	TX20 ●	200
100051	5,0 x 50	TX25 ●	200
100052	5,0 x 60	TX25 ●	200
100053	5,0 x 70	TX25 ●	200
100054	5,0 x 80	TX25 ●	200
100058	5,0 x 100	TX25 ●	200
100051-EIMER	5,0 x 50	TX25 ●	500
100052-EIMER	5,0 x 60	TX25 ●	500
100053-EIMER	5,0 x 70	TX25 ●	500
100054-EIMER	5,0 x 80	TX25 ●	500

## Hapatec Heli

Stainless steel A2

Stainless Steel

Can be combined with EPDM façade tape



A2 stainless steel

- Limited resistance to acid
- Not suitable for atmospheres containing chlorine

Art. no.	Dimensions [mm]	Drive	PU
100060	5,0 x 50	TX25 ●	200
100062	5,0 x 60	TX25 ●	200
100060-EIMER	5,0 x 50	TX25 ●	500
100062-EIMER	5,0 x 60	TX25 ●	500



# Hobotec screws



Hobotec screws enable simple, fast and clean connections of wood to wood. These screws are used in particular in applications where there is an increased danger of cracking and splitting. The type of thread and the innovative drill point enable a clean fit and high extraction resistance values.

**Specially suitable for** applications in model construction, stairs construction, façade construction for carpentry work, joinery and roofing.



© fotolia.de

### Application range for screws made of hardened stainless steel:

- This steel combines the best properties of carbon and stainless steels. Conditionally rust-resistant like an A2 with the high mechanical values of a galvanised steel. Hardened stainless steel is not acid-resistant, which is why it is also not suitable for fastening wood containing tanning agents (e.g. oak).
- Hardened stainless steel can be magnetised.
- Stainless steel in accordance with DIN 10088.

For further information on possibilities for using hardened stainless steel see p. 18

## Hobotec screw

Hardened stainless steel

Can be combined with  
**EPDM**  
façade tape

Stainless Steel



### Advantages

- No pilot drilling required
- No cracking or splitting in narrow edge areas
- No hammering of the screws through TX drive

Art. no.	Dimensions [mm]	Drive	PU
903323	4,0 x 30	TX15 ●	500
110299	4,0 x 40	TX15 ●	500
110300	4,0 x 45	TX15 ●	500
110301	4,0 x 50	TX15 ●	500
110302	4,0 x 60	TX15 ●	500
110319	4,5 x 40	TX20 ●	200
944839	4,5 x 45	TX20 ●	200
110303	4,5 x 50	TX20 ●	200
110304	4,5 x 60	TX20 ●	200
110305	4,5 x 70	TX20 ●	200
110306	4,5 x 80	TX20 ●	200
110307	5,0 x 50	TX25 ●	200
110308	5,0 x 60	TX25 ●	200
110309	5,0 x 70	TX25 ●	200
110310	5,0 x 80	TX25 ●	200
110311	5,0 x 90	TX25 ●	200
110312	5,0 x 100	TX25 ●	200
110313	6,0 x 80	TX25 ●	100
110314	6,0 x 90	TX25 ●	100
110315	6,0 x 100	TX25 ●	100
110316	6,0 x 120	TX25 ●	100
110317	6,0 x 140	TX25 ●	100
110318	6,0 x 160	TX25 ●	100



© fotolia.de

## Hobotec ornamental head

Hardened stainless steel

Can be  
combined with  
**EPDM**  
façade tape

Stainless Steel



### Application

- Façades
- Fences
- Decks



Art. no.	Dimensions [mm]	Drive	PU
945040	4,0 x 40	TX15 ●	500
945653	4,0 x 45	TX15 ●	500
945041	4,0 x 50	TX15 ●	500
945042	4,0 x 60	TX15 ●	500
945043	4,0 x 70	TX15 ●	500
945045	4,5 x 40	TX20 ●	200
945046	4,5 x 45	TX20 ●	200
945047	4,5 x 50	TX20 ●	200
945048	4,5 x 60	TX20 ●	200
945049	4,5 x 70	TX20 ●	200
945050	4,5 x 80	TX20 ●	200
945051	5,0 x 50/30	TX25 ●	200
945052	5,0 x 60/36	TX25 ●	200
945053	5,0 x 70/42	TX25 ●	200
945054	5,0 x 80/48	TX25 ●	200
945055	5,0 x 90/54	TX25 ●	200
945056	5,0 x 100/60	TX25 ●	200

The type of thread and the innovative drill point enable a clean fit and high extraction resistance values. **Particularly suitable** for brittle woods. **Not suitable** for tannin-rich woods such as cumarú, oak, merbau, robinia, etc.



On request, screw heads can be painted in RAL Colours

These screws are used in particular in applications where there is a high risk of splitting.

E.g. when laying wood floors, wood mouldings, etc.



 On request, screw heads can be painted in RAL Colours

### Hobotec ornamental head

Steel blue galvanised



Art. no.	Dimensions [mm]	Drive	PU
110287	3,2 x 20	TX10 ◯	500
110288	3,2 x 25	TX10 ◯	500
110289	3,2 x 30	TX10 ◯	500
110290	3,2 x 35	TX10 ◯	500
110291	3,2 x 40	TX10 ◯	500
110292	3,2 x 50	TX10 ◯	500
110293	3,2 x 60	TX10 ◯	500

Also available with head painted white

w110288	3,2 x 25	TX10 ◯	500
w110289	3,2 x 30	TX10 ◯	500
w110290	3,2 x 35	TX10 ◯	500
w110291	3,2 x 40	TX10 ◯	500
w110292	3,2 x 50	TX10 ◯	500
w110293	3,2 x 60	TX10 ◯	500

### Hobotec ornamental head

Hardened stainless steel



**Stainless Steel**



Art. no.	Dimensions [mm]	Drive	PU
900782	3,2 x 25	TX10 ◯	500
110294	3,2 x 30	TX10 ◯	500
110295	3,2 x 35	TX10 ◯	500
110296	3,2 x 40	TX10 ◯	500
110297	3,2 x 50	TX10 ◯	500
110298	3,2 x 60	TX10 ◯	500

### Hobotec ornamental head

Brass-plated



Art. no.	Dimensions [mm]	Drive	PU
903436	3,2 x 25	TX10 ◯	500
903437	3,2 x 30	TX10 ◯	500
903438	3,2 x 35	TX10 ◯	500
903439	3,2 x 40	TX10 ◯	500
903440	3,2 x 50	TX10 ◯	500
903441	3,2 x 60	TX10 ◯	500

### Hobotec ornamental head

Steel yellow galvanised



Art. no.	Dimensions [mm]	Drive	PU
110280	3,2 x 20	TX10 ◯	500
110281	3,2 x 25	TX10 ◯	500
110282	3,2 x 30	TX10 ◯	500
110283	3,2 x 35	TX10 ◯	500
110284	3,2 x 40	TX10 ◯	500
110285	3,2 x 50	TX10 ◯	500
110286	3,2 x 60	TX10 ◯	500
944778	4,2 x 70	TX15 ●	200
944779	4,2 x 80	TX15 ●	200



# Mammutec screw

Suitable for stronger wood surfaces

## Mammutec screw

The Mammutec is specially designed for the attachment of stronger wooden flooring with a thickness of up to a maximum of 60 mm. The Mammutec screw can also be used in jetties and piers due to its high corrosion resistance.



## Mammutec

Stainless steel A4

Stainless Steel

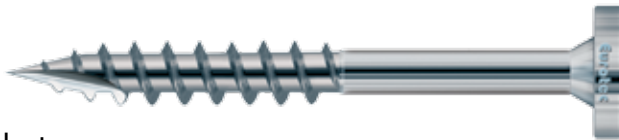

### Advantages

- Corrosion resistance
- Fixing of wood coverings with a thickness of up to 60 mm

### Application information

Pre-drilling and countersinking of 6 mm is absolutely necessary! This gives you space for the shaft. Due to the material thickness, there is always the risk of screw shearing due to shrinkage and swelling of the timber.

This must be observed during assembly.

Art. no.	Dimensions [mm]	Drive	PU
905575	8,0 x 100	TX40 •	50
905576	8,0 x 120	TX40 •	50

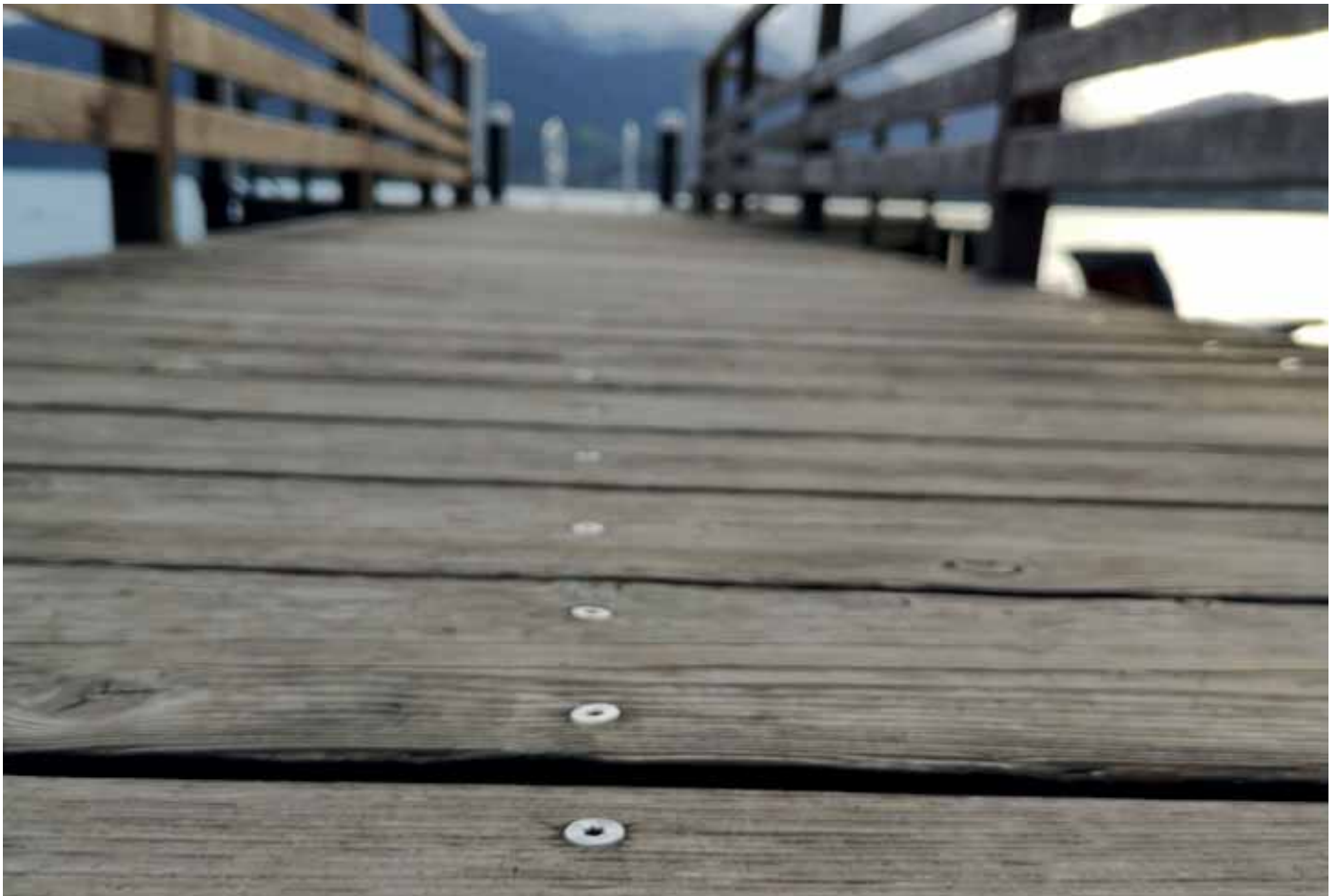

## Aids for laying decking boards



### Bit dispenser box

A practical dispenser box with **100 x TX Long Bits** or **50 x Magnet TX Long Bits** in the sizes: TX20, TX25, TX30 or TX40.

The **magnet bits** provide an extremely strong hold and therefore prevent screws from falling. Even long screws remain securely held in place, even in a horizontal position.

The **TX Long Bit** is ideal for use in hard-to-reach places, e.g. deck boards, cladding, etc.

### Bit dispenser box with TX Long Bits

Black

Art. no.	Size	Bit	Content	PU
954102	TX20		100	1
954103	TX25		100	1
954104	TX30		100	1
954105	TX40		100	1

### Bit dispenser box with Magnet TX Long Bits

Black

Art. no.	Size	Bit	Content	PU
954106	TX20		50	1
954107	TX25		50	1
954108	TX30		50	1
954109	TX40		50	1

### Bit holder



Art. no.	Length [mm]	Art. no.	PU
500011	66		1
500012	150		1
500013	500		1

## Bit-Box

Specially made for wood construction



### Description

31 TX bits and 1 quick-change bit holder in a practical box with a belt clip.



Available to order individually or as a 10-pack incl. Sales display.

Art. no.	Content	PU
945857	5 x TX10 ○	1
	5 x TX15 ●	
	5 x TX20 ●	
	5 x TX25 ●	
	5 x TX30 ●	
	6 x TX40 ●	
	1 x quick-change bit holder	

## Universal Bit-Box

For universal applications



### Description

48 bits and 1 quick-change bit holder in a practical box.

Art. no.	Description	PU
945858	⊕ PH 1-1-2-2-3-3	1
	⊕ PZ 1-1-2-2-3-3	
	○ Hex 4-4-5-5-6-6	
	□ Square 1-1-2-2-3-3	
	⊗ TX 10-10-15-15-20-20-25-25-27-27-30-30	
	⊗ SI-TX 10-10-15-15-20-20-25-25-27-27-30-30	
	1 x quick-change bit holder	

## Angled screwing attachment

For hard-to-reach locations



Art. no.	Description	PU*
499999	Angled screwing attachment	1

\* Comes supplied with 1 bit each for TX20, TX25 and TX30

- Head angled at 90°
- Compatible with all standard bits and machines
  - Magnetic 1/4" hexagonal bit holder
  - 1/4" hexagonal machine inputs
- Handle can be rotated and locked in 30° steps
- Suitable for clockwise and anti-clockwise rotation
- Maximum torque: 62 Nm
- Maximum speed of rotation: 2000 U/min



## Stainless steel Long Bit

1/4" x 50 mm



Art. no.	Size	Bit	PU
500055	TX10 ◯		20
500056	TX15 ●		20
500057	TX20 ●		20
500058	TX25 ●		20
500059	TX30 ●		20

### Advantages

- Protection against the risk of flash rust
- Avoidance of follow-up costs due to flash rust

## Magnet TX Long Bit

1/4" x 50 mm



Art. no.	Size	Bit	PU
499993	TX10 ◯		5
499994	TX15 ●		5
499995	TX20 ●		5
499996	TX25 ●		5
499997	TX30 ●		5
499998	TX40 ●		5

### Content

- 5 Magnet TX Long Bits in a practical blister pack with standard European perforation

### Advantages

- Extremely strong hold in every position
- No falling screws

### Description

The magnet bits from Eurotec provide an extremely strong hold and therefore prevent screws from falling. Even long screws remain securely in place, and even in a horizontal position.

## Magnet Bit Set



6 sizes in a blister pack.

Art. no.	Size	Art. no.	PU
499992	TX10 / TX15 / TX20 / TX25 / TX30 / TX40		6



## 12in1 ratchet screwdriver



Art. no.	Dimensions [mm] <sup>a)</sup>	Weight [g]	PU
800490	250 x 35	265	1

<sup>a)</sup> Length x Width



### Advantages

- Ratchet function - saves having to regripping
- 12 bits in the extendible clip
- Ergonomic and non-slip handle

## TX Bit

1/4" x 25 mm



Art. no.	Size	Bit	PU
Length: 25 mm			
945851	TX10 ○		10
945852	TX15 ●		10
945853	TX20 ●		10
945854	TX25 ●		10
945855	TX30 ●		10
945856	TX40 ●		10

## TX Long Bit

1/4" x 50 mm



Art. no.	Size	Bit	PU
Length: 50 mm			
954666	TX10 ○		20
945975	TX15 ●		20
945976	TX20 ●		20
945977	TX25 ●		20
945978	TX30 ●		20
945979	TX40 ●		20
954658	TX50 ●		10

### Advantage

A firm hold in any position!

### Description

The long bit is suitable for use in hard-to-reach places, such as terrace boards, cladding and so on. It is suitable for use with common electric / battery-powered screwdrivers and can thus be used directly or with an adapter.

- The long bit can be used for relatively inaccessible connections such as two wooden boards. Fixing is an absolute doddle, and no damage is caused to the boards by a drill chuck.



**Tip**  
Simply connect 6 long bit packages (each containing 20 bits of one size) ... and you'll have a handy storage box.

## Quick-change bit holder

Can be used for all 1/4" bits of any length



Art. no.	Description	PU*
945850	Quick-change bit holder 1/4" x 25 mm Bit	1

\* Bit supplied separately

### Description

Eurotec's bit holder is an ideal auxiliary tool for any craftsman. Once the bit is inserted into the bit holder, it no longer falls out by itself.

## Spacers

With this spacer, 4 different joint dimensions can be set when laying the boards (4, 5, 6 and 8 mm).

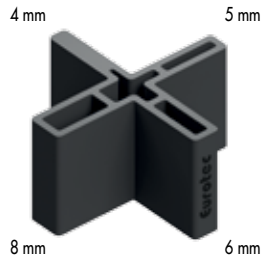

Art. no.	Dimensions [mm]	Material	PU
945381	42 x 22	Plastic, black	25

## Tenax spacer

If deck boards are to be screwed directly, ie visibly, the Tenax serves as a spacer to the underlay to prevent waterlogging in the joint. By placing the boards on top, the joint gap of 6 mm and the clearance to the substructure are set.

- Optimum back ventilation
- Optimum clearance



Art. no.	Dimensions [mm]	Material	PU
945968	11 x 30 x 86	Plastic, black	300



## Tension clamp

Incl. detachable plastic jaws



The tension clamp is an essential aid for laying deck boards. Use at least 4 tension clamps to bring the boards into shape along their whole length. Along with the spacers, for example, this achieves an even joint pattern with straight deck boards.

Art. no.	Dimensions [mm]	Material	PU
945380	270 x 830 x 55	Hard plastic/steel	1





## Drill-Stop

Countersinking for deck screws



For Terrasotec Ø 5 and  
Hapatec Ø 5 mm and  
Hapatec Heli Ø 5 mm

Pilot drilling is strongly recommended for fastening tropical woods/hardwoods. This is advisable even with the relatively easily splittable Douglas fir, and when screwing close to wood cut against the grain.

- Boring and countersinking in a single pass
- Screwing torque for inserting Terrasotec and Hapatec screws is greatly reduced, i.e. no more shearing of the screws, above all with the combination of hardwood/stainless steel A2 or A4.
- Perfect seat of the screw head

Art. no.	Dimensions [mm] <sup>a)</sup>	Material	Stopper collar	PU
945986	Ø 4,7 x 25	Hard plastic/steel	orange	1

a) Drilling diameter x drilling depth

## Drill-Stop for Profile drilling screw

Countersinking for Profile drilling screw



Pilot drilling is strongly recommended for fastening tropical woods/hardwoods. This is advisable both for Douglas fir, which is relatively easy to split, and when screwing close to wood cut against the end grain.

- Boring and countersinking in a single pass
- The screwing-in torque for inserting profile drilling screws is greatly reduced, i.e. no more screw shearing, particularly when combining hardwood and A2 or A4 stainless steel
- Perfect seat of the screw head
- Optimised for the Eurotec 5,5 mm profile drilling screw

Art. no.	Dimensions [mm] <sup>a)</sup>	Material	Stopper collar	PU
945606	Ø 5,6 x 26	Hard plastic/steel	blue	1

a) Drilling diameter x drilling depth

## Screw Stop

Screw coupling with depth stopper



The Screw Stop is the ideal solution for driving screws to an even depth into the wood. In this way, your deck will be given an attractive, even surface pattern. You adjust the required screwing depth with the infinitely adjustable depth stopper. When this is reached, the drive uncouples and the screw stops. You do not have to start again to adjust the seat of the screw head.

Art. no.	Dimensions [mm]	Material	PU*
500000	61,5 - 70 ; Ø 24	Hard plastic/steel	1

\* Incl. TX25 Bit. The bit is locked in place by a lock washer and can be changed by using a pincer.



# Façadeclip

For hidden fastening of façade wood

## Façadeclip

Black, electrogalvanised

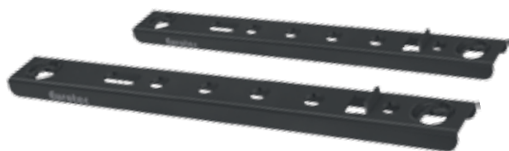

### Advantages

- For façade timbers with a profile height of 57–95 mm
- Hidden fastening
- Perfect constructive timber protection
- Ventilated façade system with spaced installation
- The façade timber's surface that is exposed to the weather remains undamaged
- Efficient and easy installation



Art. no.	Dimensions [mm] <sup>a)</sup>	Type	PU*
946010	5,5 x 115 x 15	F115 x 17	300
946012	5,5 x 115 x 15	F115 x 22	300
946013	5,5 x 115 x 15	F115 x 28	300
946014	5,5 x 130 x 15	F130 x 17	300
946015	5,5 x 130 x 15	F130 x 22	300
946016	5,5 x 130 x 15	F130 x 28	300
946017	5,5 x 145 x 15	F145 x 17	300
946018	5,5 x 145 x 15	F145 x 22	300
946019	5,5 x 145 x 15	F145 x 28	300

a) Height x length x width  
\* Screws are included with this product

## Technical data

Eurotec Façadeclip			Dimensions façade profile			Joint clearance between façade profiles		Quantity required Façade clips per m <sup>2</sup> Example			
Art. no.	Type	Dimensions [mm]			min.-max. height	min. strength	Assembly screw Length (L)	Fixing screw in hole A	Fixing screw in hole B	min. profile height	max. profile height
		H	W	L	[mm]	[mm]	[mm]	[mm]	[mm]	Stück	Stück
946010	F115 x 17	5,5	115	15	57 - 68	19	17	10	variable	28	24
946012	F115 x 22	5,5	115	15	57 - 68	24	22	10	variable	28	24
946013	F115 x 28	5,5	115	15	57 - 68	30	28	10	variable	28	24
946014	F130 x 17	5,5	130	15	68 - 80	19	17	10	variable	24	20
946015	F130 x 22	5,5	130	15	68 - 80	24	22	10	variable	24	20
946016	F130 x 28	5,5	130	15	68 - 80	30	28	10	variable	24	20
946017	F145 x 17	5,5	145	15	80 - 95	19	17	10	variable	20	18
946018	F145 x 22	5,5	145	15	80 - 95	24	22	10	variable	20	18
946019	F145 x 28	5,5	145	15	80 - 95	30	28	10	variable	20	18

Fastened to substructure with 4,5 x 29 mm fixing screw with drill point

Formula for determining quantity  
(1000 mm/substructure distance) x (1000 mm/bottom edge clearance) = pieces/m<sup>2</sup>

600 mm substructure clearance  
10 mm joint clearance

Please note: Before any work is carried out, all calculations must be checked and released by the responsible planner! For more information on this visit our homepage: [www.eurotec.team/en](http://www.eurotec.team/en)

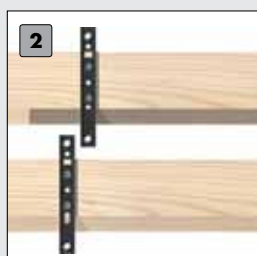

## Efficient and easy installation

- 1 Place Façadeclip on the back with stopper and insert assembly screws
- 2 Repeat on all façade boards displaced
- 3 FScrew the façade wood to the counter-lathe with fixing screw
- 4 Simply insert the next façade wood and screw on the top only with fixing screw

- 5 The joint clearance is set automatically by the screw head of the fixing screw, that's it!

Each Façadeclip comes supplied with one 4,5 x 29 mm fixing screw with a drill point and two 4,2 x L assembly screws.

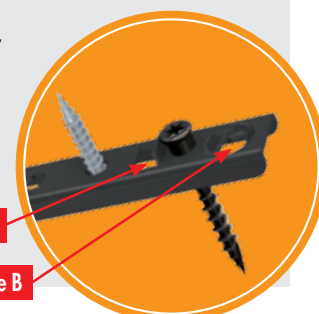



# Façadeclip for Rhombus profiles

For use with the most common façade profiles

## Façadeclip for Rhombus profiles

System consisting of a Façadeclip Rhombus Starter and a Façadeclip Rhombus

Façadeclip Rhombus

Façadeclip Rhombus Starter

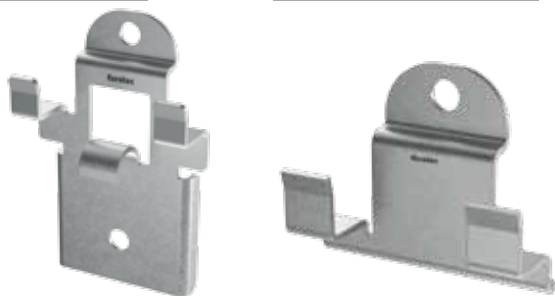

### Advantages

- Optimised rear ventilation by constructive timber protection - Exclusive to Eurotec!
- Invisible fastening
- Formation of fixed points and sliding points
- Easy installation
- Weather-resistant

### Properties

Using the clip creates a joint dimension of 6 mm. The clip was designed so that it does not rest flat on the substructure, instead it elevates the boards by 4mm from the substructure. The constructional wood protection allows for rear ventilation of the façade, which is not the case with any of the usual products. Rear ventilation results in better drying when the façade is exposed to rain, and water can run off between the clip and substructure. The constructional measures increase the façade's service life.

## Properties Rhombus Profiles

- Dimensional stability must be provided for wood
- Low to moderate gross density
- Low swelling and shrinkage
- Suitable for wood that is low in tannin

### Coniferous woods\*



### Thermally modified timber\*

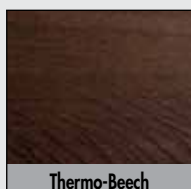

\* Other wood can also be used, but please ask your wood supplier.

Art. no.	Description	Dimensions [mm] <sup>a)</sup>	Material	PU*
944917-50	Façadeclip Rhombus	15,20 x 54,5 x 29,5	Galvanised steel	50
944917-200	Façadeclip Rhombus	15,20 x 54,5 x 29,5	Galvanised steel	200
944918	Façadeclip Rhombus Starter	15,25 x 29,5 x 36,0	Galvanised steel	25

a) Height x length x width

\* Incl. screws

## Technical data:

Façadeclip Rhombus

Façadeclip Rhombus Starter

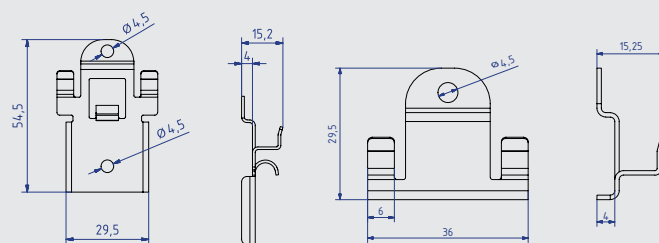

## Profile

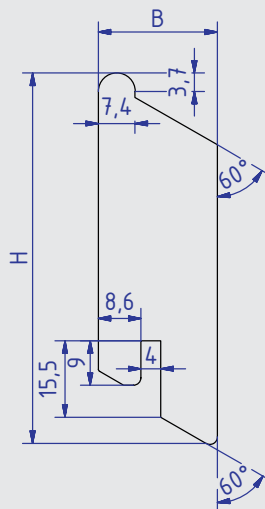

## Wall-connection



## Detail A



In the case of vertical installation, the following points must be observed when using the Façadeclip Rhombus Starter. We recommend making a 15° undercut for forming a drip edge in the rhombus profile. The Façadeclip Rhombus Starter fits perfectly with a 4 mm wide groove slit in the wood profile (see detail A).

Dimensions		
Variants	Height H [mm]	Width W [mm]
Variants 1	70	21
Variants 2	75	24

## Installation instructions: Horizontal fixing

- 1** The Façadeclip Rhombus Starter must be attached to the lower end of the façade. Can be fixed and aligned with the enclosed screw. This is done over the entire length of the façade.

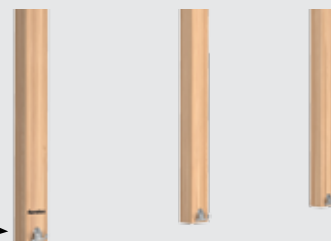

- 2** The first board can be placed on the pre-fixed Façadeclips Rhombus Starter. Through the fixation to the substructure, the profile lays securely on to the pre-assembled clips.

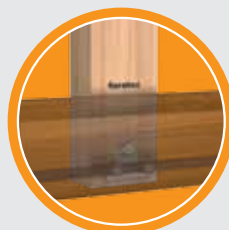

- 3** It is recommended to install the first Façadeclip Rhombus in the middle of the first profile. This will give the first profile a better hold.

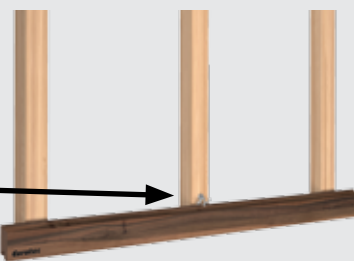
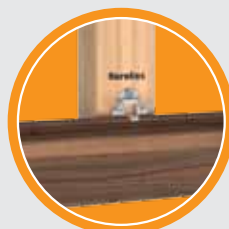

- 4** The remaining Façadeclips Rhombus can be mounted along the profile. For this purpose they are pushed between the plank and the substructure and fixed with the enclosed screw. The screws of all clips must be sufficiently tightened.

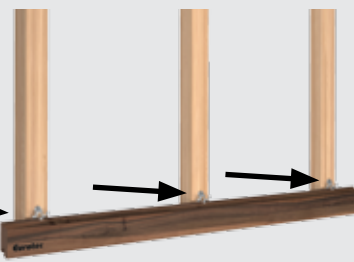
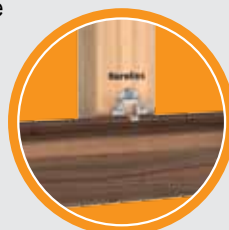

- 5** In this step the next plank is inserted. From here, steps **3 and 4** are repeated until the façade is completely closed.

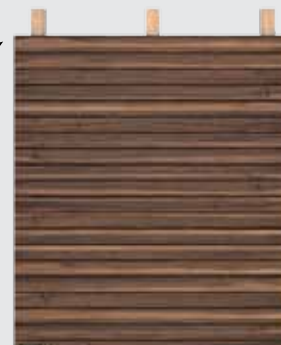

For areas where windows, doors, floorboard joints or the end of the façade is/are located, fixed points can be formed thanks to the prefabricated hole in the Façadeclips Rhombus. To achieve this, the clip is firstly screwed down on the rear of the profile. The clip can then be screwed to the substructure.

## Installation instructions: Vertical fixing

- 1** The Façadeclip Rhombus Starter must be fixed and aligned at the first substructure joist of the façade with the enclosed screw. This is done over the entire length of the façade. The specified dimensions of the profile to be installed must be taken into account.

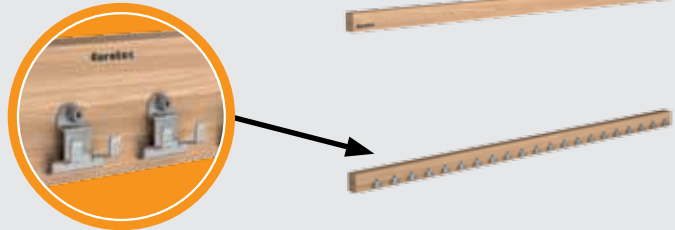

- 2** Façadeclips Rhombus Starter must also be installed to the end of each further substructure joist (right or left). These must be aligned along the substructure.

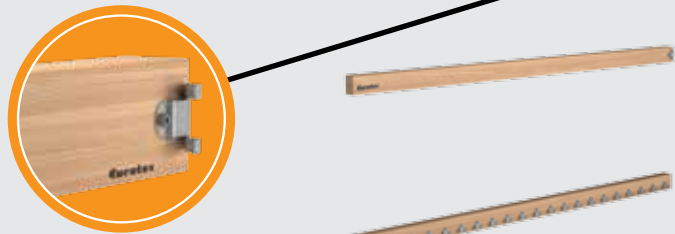

- 3** A slot has to be milled at the end of each board. This is placed on the first pre-assembled Façadeclip Rhombus Starter. Due to the laterally attached Façadeclips Rhombus Starter, the profile should already have a certain fixation on the wall. In order to optimise this, it is advisable to mount a Façadeclip Rhombus on one of the middle substructure profiles.

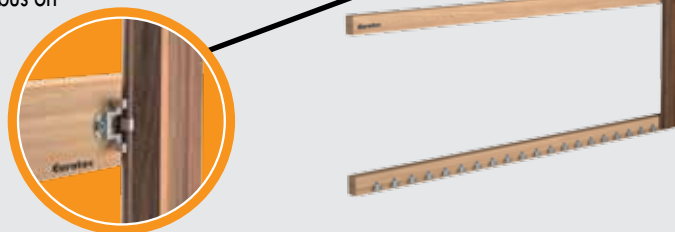

- 4** The remaining Façadeclips Rhombus can be mounted along the profile. Place the clips between the board and the substructure joist and fix them with the enclosed screw. The screws of all clips must be sufficiently tightened. The information provided as in the remark applies to fixed points in the event of horizontal installation.



The function can only be guaranteed when the specifications are complied with.



# Façade fixing screw ZK

For the non-visible attachment of rhombus profiles

## Façade fixing screw ZK

Ornamental head, hardened stainless steel

Stainless Steel



### Advantages

- Non-visible attachment
- Milling ribs enable easy countersinking for all types of wood
- Short thread for compact bolting to the substructure and the rhombus profile
- Corrosion-resistant up to and including service class 3 - "freely exposed constructions" according to DIN EN 1995 (Eurocode 5)

### Application information

The particular screw geometry decreases the risk of splitting the wood. Pre-drilling, however, is strongly recommended, in particular for hardwoods used for the façade construction!

## Assembly instructions for horizontal profile arrangement

**1** Uniformly position the rhombus profiles.

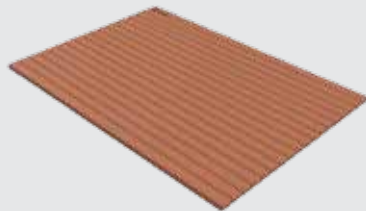

**2** Uniformly position the substructure at right angles to the rhombus profiles.

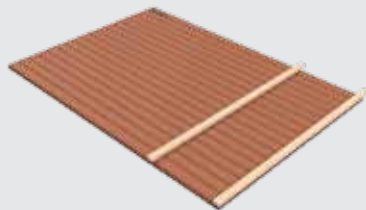

**3** Bolt the lowest rhombus profile to the substructure using the ZK façade screws.

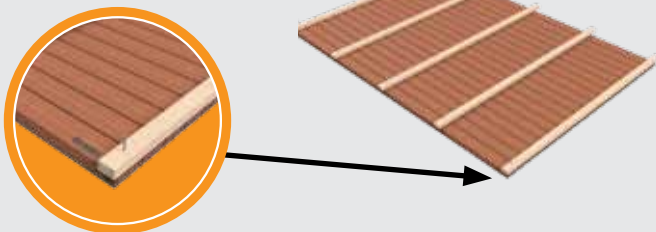

Art. no.	Dimensions [mm]	Drive	PU
905577	5,5 x 40	TX25 •	200
905578	5,5 x 45	TX25 •	200
905579	5,5 x 50	TX25 •	200
905580	5,5 x 55	TX25 •	200
905581	5,5 x 60	TX25 •	200
905582	5,5 x 70	TX25 •	200
905583	5,5 x 80	TX25 •	200
905585	5,5 x 90	TX25 •	200
905584	5,5 x 100	TX25 •	200

### Profile

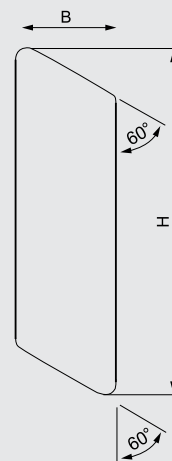

### Wall-connection



**4** Inspect the spacing to the next rhombus profile, bolt the profile to the substructure and repeat **step 4** until all profiles are fastened.

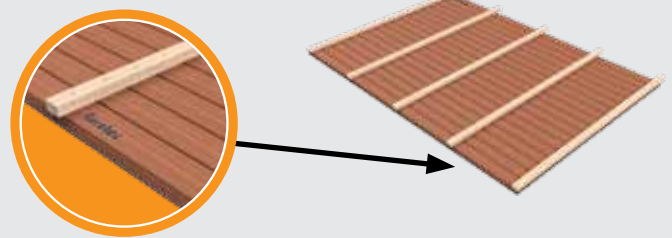

**5** Install the wall element and mount it to the wall.

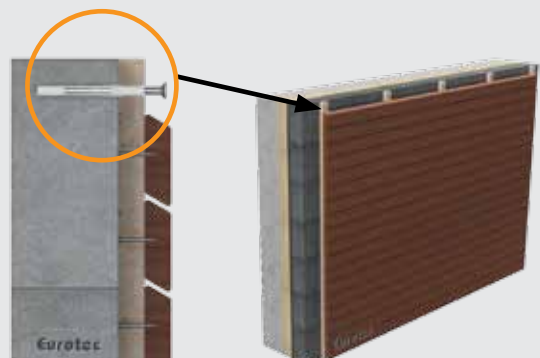

# PediX post feet

Quick to assemble, with an especially high load-bearing capacity



## What can it be used for?

- For anchoring wooden posts of wooden structures onto concrete foundations
- Carports, canopies, patio roofs

## Advantages

- Easy assembly without milling
- Subsequently adjustable in height up to 50, 100 and 150 mm
- The PediX 300 + 150 and the PediX 300 + 150 HV enable the increased demands on constructive wood preservation according to DIN 68800-2
- High load capacity according to ETA 13/0550
- Additional constructive timber protection thanks to gasket on end grain
- Min. timber cross section of 100 x 100 mm
- Hot-dip galvanised structural steel S235JR (ST37-2)
- Meets the requirements of constructive wood preservation, thus increasing the longevity of the wood construction (protection against splashing water)
- Can be used in the usage classes 1, 2 and 3 in accordance with DIN EN 1995-1-1

## Installation

- Simple assembly with fully threaded screws and no need for joinery work, pilot-drilling or milling
- Comes supplied with 12 fully threaded A2 screws measuring 5,0 x 80 mm



Suitable for this:  
Rock concrete screw hexagonal  
BIM A2 10,5 x 95 mm  
Art. no.: 110355











© mib - stock.adobe.com





# PediX post feet

Technical data

Name	Art. no.	Height adjustment in assembled state	Min. post cross section	Dimensions of baseplate	Compressive loadbearing capacity	Tensile loadbearing capacity	Lateral force resistance <sup>1)</sup>	PU
Post feet on concrete		[mm]	[mm]	H x L x W [mm]	$N_{c,d}$ [kN]	$N_{t,d}$ [kN]	$V_{R,d}$ [kN]	pcs.
PediX 140+50 	904681	140 - 190	100 x 100	8 x 160 x 100	48,0	9,2	-	4
PediX 190+100 	904682	190 - 290	100 x 100	8 x 160 x 100	30,9	9,2	-	4
PediX 300+150 	904689	300 - 450	100 x 100	8 x 160 x 100	16,2	9,2	-	4
PediX 140+50 HV 	904681-HV	140 - 190	100 x 100	8 x 160 x 100	48,0	9,2	3,5	4
PediX 190+100 HV 	904682-HV	190 - 290	100 x 100	8 x 160 x 100	35,4	9,2	2,9	4
PediX 300+150 HV 	904689-HV	300 - 450	100 x 100	8 x 160 x 100	34,5	8,6	2,3	4
Post feet in concrete		Height adjustability [mm]	[mm]	H x L x W [mm]	$N_{c,d}$ [kN]	$N_{t,d}$ [kN]	$V_{R,d}$ [kN]	pcs.
PediX B500 	904683	-	100 x 100	-	49,0	24	4,6	4
PediX B500+50 	904686	50	100 x 100	-	44,9	23	-	4

1) The lateral force resistance must be overlaid with the compressive and tensile load in accordance with ETA-13-/0550 and can therefore lead to lower load-bearing capacities.

Please note: The stated values are only intended as planning aids. They are subject to typographical and printing errors. Projects must only be calculated by authorised persons.

## Installation instructions: You will find more-detailed information in our installation instructions

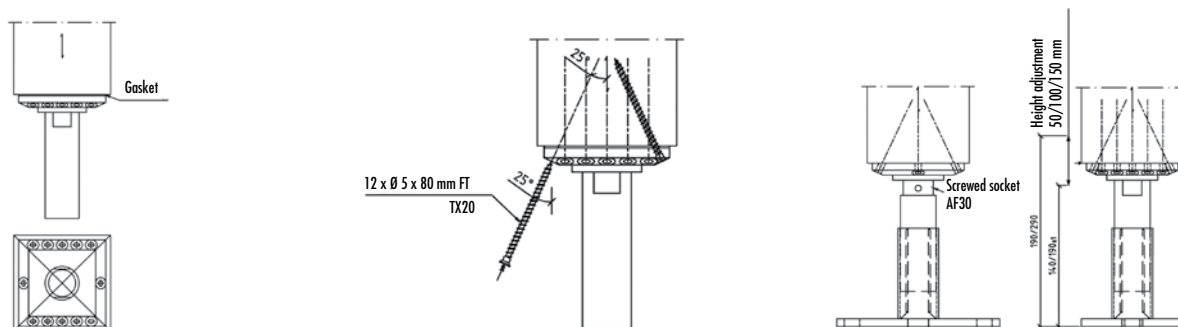

The PediX post foot can be attached easily to the end grain. Place the seal on the support foot and then place both parts centrally on the end grain surface.  
Note: To make assembly easier, the base plate and the cover sleeve can be unscrewed.

After centering the head plate, screw in the 12 A2 full-thread 5,0 x 80 mm screws at an angle of 25° without base plate.

The protective sleeve and the pilot drilling can be reinstalled after all screws are fitted. After the post is erected with the post foot installed, it can be anchored on a concrete foundation with two or four cavity-wall ties or concrete bolts. Once the foot is installed on the socket, its height can be adjusted using an AF30 spanner.

Please note: Do not screw the post foot to a height greater than 190, 290 or 450 mm respectively.



# PediX Easy 135+65 / 200+100

## PediX Easy 135+65 / 200+100



Art. no.	Name	Dimensions of baseplate [mm] <sup>a)</sup>	Height adjustment in assembled state	PU*
904678	PediX Easy 135+65	160 x 100 x 6	135 - 200	4
904684	PediX Easy 200+100	160 x 100 x 6	200 - 300	4

a) Length x width x height

\*Delivery incl. twelve A2 fully threaded screws (Ø 5,0 x 80 mm) per post support

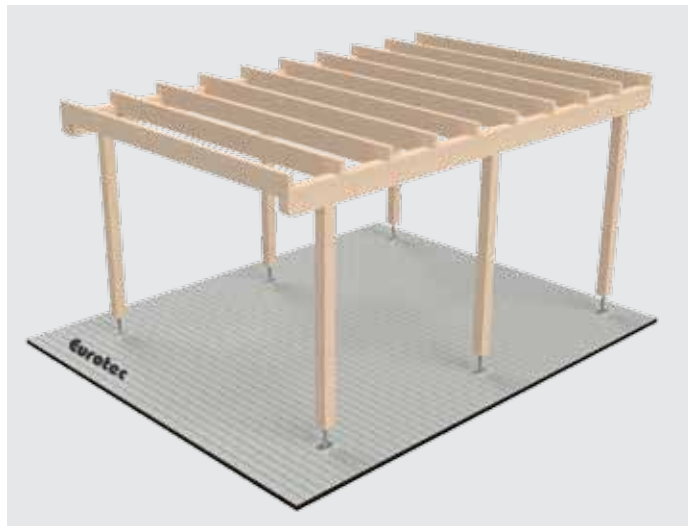
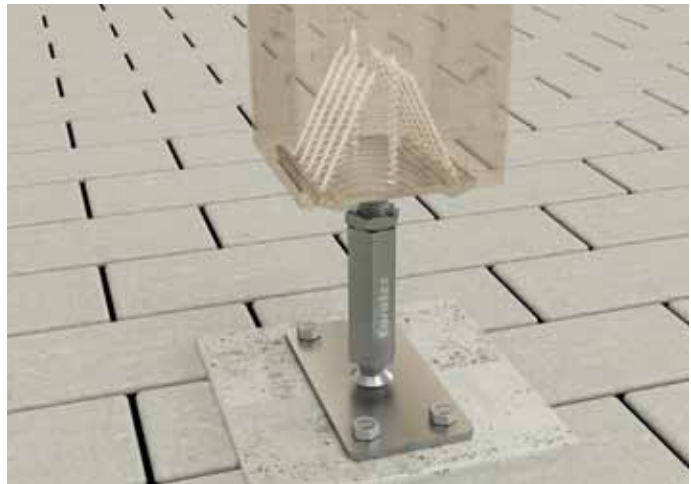

### Advantages / Properties

- Simple assembly with fully threaded screws and no need for joinery work, pilot-drilling or milling
- Min. timber cross section of 100 x 100 mm
- Can be used in the usage classes 1, 2 and 3 in accordance with DIN EN 1995-1-1

### Product description

The PediX Easy 135+65 and PediX Easy 200+100 are post supports for lightweight timber structures that meet structural wood preservation requirements. They can be assembled on the end grain without any need for additional joinery work or pilot drilling using fully threaded screws. Following assembly, the height of the support pedestals can still be adjusted by 65 mm or 100 mm. Thanks to the height adjustment, manufacturing tolerances relating to the structure and subsequent settlement in the individual foundations can be balanced out. The PediX Easy 135+65 and PediX Easy 200+100 can also absorb horizontal loads. The pedestal's durability is guaranteed by a zinc/nickel coating.

# PediX Duo 150+45 / 190+80

## PediX Duo 150+45 / 190+80



### Advantages / Properties

- Simple assembly with fully threaded screws and no need for joinery work, pilot-drilling or milling
- The bayonet lock makes assembling the support pedestal and the structure extremely easy
- Two-part structure
- Min. timber cross section of 100 x 100 mm
- Can be used in the usage classes 1, 2 and 3 in accordance with DIN EN 1995-1-1

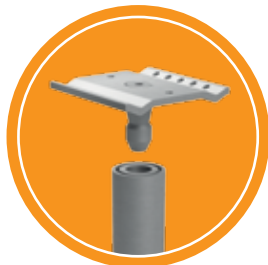

### Product description

The PediX Duo 150+45 and PediX Duo 190+80 are post supports for lightweight timber structures that meet structural wood preservation requirements. The pedestals' durability is guaranteed by a zinc/nickel coating. The post supports can be assembled on the support's end grain without any need for additional joinery work or pilot drilling using fully threaded screws. The bayonet lock permits extremely easy assembly of the top part with the assembled support and the anchored bottom part. The connection is locked by plugging in and pulling up the lock. The connection established in this way can even transfer tensile forces from the support to the foundation. Following assembly, the height of the support pedestal can still be adjusted by 45 mm or 80 mm.

If you have any further questions about assembly, please refer to our assembly instructions or contact our Application Engineering Department (Technik@eurotec.team)

Art. no.	Name	Dimensions of baseplate [mm] <sup>a)</sup>	Height adjustment in assembled state	PU*
904679	PediX Duo 150+45	160 x 100 x 8	150 - 195	4
904680	PediX Duo 190+80	160 x 100 x 8	190 - 270	4

a) Length x width x height

\*Delivery incl. twelve A2 fully threaded screws (Ø 5,0 x 80 mm) per post support

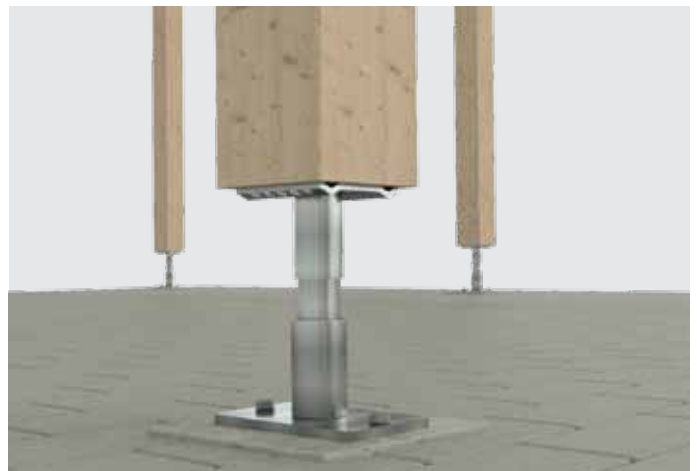

# H post anchor, Fence post connection screw, Post cap, Hammer-in ground sockets

## H post anchor

Hot-dip galvanised steel

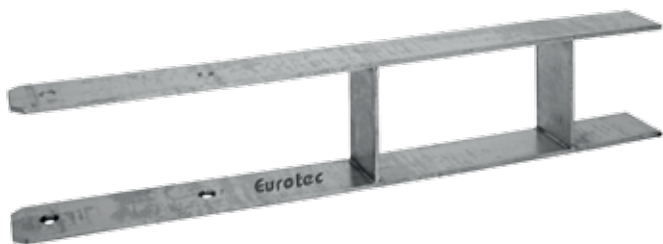

- For fixing square timber posts in place
- Fixed into concrete using H anchor
- Excellent corrosion protection thanks to hot-dip galvanisation

Art. no.	Fork width [mm]	Dimensions <sup>a)</sup> Overall/Post support [mm]	Drill holes <sup>b)</sup> Post support [mm]	PU
Material thickness: 6 mm				
904737	91	600 x 60 / 300	4 x 11	1
904738	101	600 x 60 / 300	4 x 11	1
904739	121	600 x 60 / 300	4 x 11	1
904740	141	600 x 60 / 300	4 x 11	1
Material thickness: 8 mm				
904741	161	800 x 60 / 400	4 x 11	1

a) Length x width / length  
b) Number x Ø



## Fence post connection screw

Specially coated

**Suitable for this**

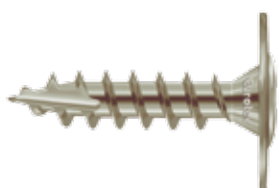

- Flange buttonhead screw Ø 8 mm
- Head diameter 22 mm
- Special tip geometry reduces the splitting effect, no pilot drilling required
- No pilot drilling required
- Special protection against corrosion
- Use, for example, in fence and pergola construction

Art. no.	Dimensions [mm]	Drive	PU
r903056	8 x 40	TX40 ●	100
r903057	8 x 50	TX40 ●	100
975594	10 x 40	TX40 ●	50
975595	10 x 50	TX40 ●	50

Not suitable for wood containing tannins!

## Fence post connection screw

A2

- Head diameter 22 mm

**Stainless Steel**



**A2 stainless steel**

- Limited resistance to acid
- Not suitable for atmospheres containing chlorine

Art. no.	Dimensions [mm]	Drive	PU
975570	8 x 40	TX40 ●	100
975571	8 x 50	TX40 ●	100



## Pyramid post cap

Hot-dip galvanised steel



- To protect posts against the effects of weathering
- Visual enhancement thanks to pyramid shape
- Excellent corrosion protection thanks to hot-dip galvanisation

Art. no.	Dimensions [mm]	PU
904733	71 x 71	1
904734	91 x 91	1
904735	101 x 101	1

## Hammer-in ground socket

For square posts



- For fixing square timber posts in place
- Socket is fixed into the ground with ground anchors
- Excellent corrosion protection thanks to hot-dip galvanisation

Art. no.	Dimensions Post socket [mm] <sup>a)</sup>	Length Spike [mm]	Drill hole Post socket [mm] <sup>b)</sup>	PU
904703	150 x 71 x 71	750	4 x 11	1
904704	150 x 91 x 91	750	4 x 11	1
904730	150 x 101 x 101	750	4 x 11	1

a) Height x length x width  
b) Number x Ø

## Hammer-in ground socket

For round posts



- For fixing round timber posts into place
- Socket is fixed into the ground with ground anchors
- Excellent corrosion protection thanks to hot-dip galvanisation

Art. no.	Dimensions Post socket [mm] <sup>a)</sup>	Length Spike [mm]	Drill hole Post socket [mm] <sup>b)</sup>	PU
904705	81 x 150	450	4 x 11	1
904706	101 x 150	450	4 x 11	1
904707	121 x 145	605	4 x 11	1

a) Ø x Height  
b) Number x Ø



# Screw-on sockets, movable post holders

Hot-dip galvanised steel

## Screw-on socket

For square posts



- For fixing square timber posts in place
- Socket is fastened to the subsurface with four screws
- Excellent corrosion protection thanks to hot-dip galvanisation

Art. no.	Dimensions Post socket [mm] <sup>a)</sup>	Dimensions Baseplate [mm] <sup>b)</sup>	Drill holes Bodenplatte/Post socket <sup>c)</sup>	PU
904695	150 x 71 x 71	150 x 150	4 x 11 / 4 x 11	1
904696	150 x 91 x 91	150 x 150	4 x 11 / 4 x 11	1
904697	150 x 101 x 101	150 x 150	4 x 11 / 4 x 11	1
904698	150 x 121 x 121	180 x 180	4 x 11 / 4 x 11	1
904736	150 x 141 x 141	200 x 200	4 x 11 / 4 x 11	1
904743	150 x 161 x 161	240 x 240	4 x 11 / 4 x 11	1
904747	150 x 181 x 181	280 x 280	4 x 11 / 4 x 11	1
904748	150 x 201 x 201	300 x 300	4 x 11 / 4 x 11	1

a) Height x length x width  
b) Length x Width  
c) Number x Ø

## Screw-on socket

For round posts



- For fixing round timber posts into place
- Socket is fastened to the subsurface with four screws
- Excellent corrosion protection thanks to hot-dip galvanisation

Art. no.	Dimensions Post socket [mm] <sup>a)</sup>	Dimensions Baseplate [mm] <sup>b)</sup>	Drill holes Baseplate/Post socket <sup>c)</sup>	PU
904701	101 x 150	150 x 150	4 x 11 / 4 x 11	1
904702	121 x 147	180 x 180	4 x 11 / 4 x 11	1

a) Ø x height  
b) Length x width  
c) Number x Ø

## Post holder

Movable, for round posts



- For fixing round timber posts into place
- Socket is fastened to the subsurface with four screws
- Movable upper section allows attachment to inclined subsurfaces
- Excellent corrosion protection thanks to hot-dip galvanisation

Art. no.	Dimensions Post socket [mm] <sup>a)</sup>	Dimensions Baseplate [mm] <sup>b)</sup>	Drill holes Baseplate/Post socket <sup>c)</sup>	PU
904713	101 x 150	140 x 130	4 x 11 / 3 x 5	1
904714	121 x 150	160 x 150	4 x 11 / 3 x 5	1

a) Ø x height  
b) Length x width  
c) Number x Ø

## U post holder

Movable, for square posts



- For fixing square timber posts in place
- Socket is fastened to the subsurface with four screws
- Movable upper section allows attachment to inclined subsurfaces
- Excellent corrosion protection thanks to hot-dip galvanisation

Art. no.	Fork width [mm]	Length Post support [mm]	Dimensions Baseplate [mm] <sup>a)</sup>	Drill holes Baseplate/Post support [mm] <sup>b)</sup>	PU
904708	71	100	100 x 100	4 x 11 / 6 x 11	1
904709	91	100	100 x 100	4 x 11 / 6 x 11	1

a) Length x width  
b) Number x Ø

# U post holders, Corner connectors, U brackets

Hot-dip galvanised steel

## U post holder



- For fixing square timber posts in place
- The bracket is fastened to the subsurface with three screws
- Post supports in sides provide spacing between the ground and the timber profile, aiding constructive timber protection
- Excellent corrosion protection thanks to hot-dip galvanisation

Art. no.	Fork width [mm]	Dimensions Post support [mm] <sup>a)</sup>	Drill holes Baseplate/Post support [mm] <sup>b)</sup>	PU
904717	71	150 x 60	2 x 11; 1 x 14 / 6 x 11	1
904719	91	150 x 60	2 x 11; 1 x 14 / 6 x 11	1
904721	101	150 x 60	2 x 11; 1 x 14 / 6 x 11	1

a) Length x width  
b) Number x Ø

## U post holder

With stone pin



- For fixing square timber posts in place
- The bracket is fixed in the concrete with a 200 mm long stone pin
- Post supports in sides provide spacing between the ground and the timber profile, aiding constructive timber protection
- Excellent corrosion protection thanks to hot-dip galvanisation

Art. no.	Fork width [mm]	Dimensions Post support [mm] <sup>a)</sup>	Dimensions Stone pin [mm] <sup>b)</sup>	Drill holes Post support [mm] <sup>c)</sup>	PU
904716	71	150 x 60	16 x 200	6 x 11	1
904718	91	150 x 60	16 x 200	6 x 11	1
904720	101	150 x 60	16 x 200	6 x 11	1
904715	121	150 x 60	16 x 200	6 x 11	1

a) Length x width  
b) Ø x height  
c) Number x Ø

## Corner connector

For square posts



- For fixing square timber posts in place
- The corner connectors are fastened to the base by four screws
- Ermöglichen eine variable Breitereinstellung
- Excellent corrosion protection thanks to hot-dip galvanisation

Art. no.	Dimensions Post socket [mm] <sup>a)</sup>	Dimensions Baseplate [mm] <sup>b)</sup>	Drill holes Baseplate/Post socket [mm] <sup>c)</sup>	PU
904710	200 x 105 x 105	82 x 155	2 x 11 / 6 x 11	1

a) Height x length x width  
b) Length x width  
c) Number x Ø

## U bracket

For fences



- For fixing round timber posts into place
- Corrosion protection

Art. no.	Fork width [mm]	Dimensions [mm] <sup>a)</sup>	Drill holes Post support [mm] <sup>b)</sup>	PU
904711	101	233 x 40	4 x 6	1
904712	121	270 x 40	4 x 6	1

a) Length x width  
b) Number x Ø



# Post support 135 + 65

Steel, blue galvanised

## Post support 135 + 65



Art. no.	Dimensions of baseplate [mm] <sup>a)</sup>	PU
904749	6 x 160 x 80	1

a) Height x width x length

### Advantages and properties

- Simple assembly with fully threaded screws and no need for joinery work, pilot-drilling or milling
- Min. timber cross section of 100 x 100 mm
- After assembly, height adjustable up to 65 mm
- S235JR (ST37-2) structural steel, blue galvanised
- Can be used in the usage classes 1 and 2 in accordance with DIN EN 1995-1-1

## Technical data: Post support 135 + 65

Name	Art. no.	Height adjustment in assembled state	Min. post cross section	Dimensions of baseplate	Compressive loadbearing capacity	Tensile load-bearing capacity	Lateral force resistance	PU
Post feet on concrete		[mm]	[mm]	L x W x H [mm]	N <sub>c,d</sub> [kN]	N <sub>t,d</sub> [kN]	V <sub>R,d</sub> [kN]	Pcs.
Post support 135 + 65	904749	135 - 200	100 x 100	6 x 160 x 80	40,0	6,1	0,8	1









## Eurotec sales shelves

For showcasing products

The Minishop and the Midishop are cost-effective and space-saving alternatives for selling Eurotec deck products.

### Minishop

- Supplied as a mini sales unit on a europallet
- Incl. model deck as an example application
- Individually stocked with Terrassotec or Hapatec screws, incl. in bucket

### The shelf has the following dimensions:

Height 110 cm, width 74 cm, depth 60 cm

### Display:

Height 70 cm, width 74 cm

### Sales sample

Use the sales sample to present the advantages of the Distance strip 2.0 and deck glider systems quickly and understandably.





Perfectly  
presented,  
explained simply and  
understandably!

With Eurotec's shelves you receive terrace accessories in the most common dimensions and materials organised onto one shelf. This gives you the opportunity to equip your customers with just one shelf for everyday terrace construction.



## Midishop

- Supplied as a midi sales unit on a europallet
- Incl. model deck as an example application
- Individually stocked with deck accessories such as Terrassotec, Rolfi, adjustable pedestals, deck gliders, bit sets, etc.

### The shelf has the following dimensions:

Height 120 cm, width 118 cm, depth 60 cm

### Display:

Height 70 cm, width 118 cm

**We deliver everything you need to explain and present the Eurotec terrace products!**

# Eurotec Deck Shop

Everything at a glance

The practical and individually combinable display system for an attractive presentation of our products in your sales area.

Product presentation in a premium display system

- Wood construction or deck shop
- Single, double ... multiple unit
- We install and set up individually for you

## Display example with 3 modules:

375 cm wide, 224 cm high, 65 cm deep;  
individual module depth 125 cm





Perfectly presented, explained simply and understandably!









# Timber engineering

Magnus hook connector	146 - 165
Atlas wood connector	166 - 169
Support-transom connector	170 - 171
Lifting Anchor, Lifting Anchor Mini	172 - 189
Round slings	190
Idee <b>Fix</b>	191 - 197
PediX post feet	198 - 201
BRUTUS threaded rod	202 - 203
KonstruX fully threaded screws	204 - 227
Wood-concrete composite system	228 - 230
A new era of wood connectors	231 - 234
Shearing angle, Shearing plate	235 - 241
CLT system angle	242 - 243
HB/HH flat shearing angle	244 - 246
Tension rod	247 - 250
Tension strap	251 - 254
Corner brackets S, M and L	255 - 256
T-profile	257
EST dowel bar, Dowel bar	258 - 259
Mounting connector	260
Façadeclip	261
Façadeclip for Rhombus profiles	262 - 264
Façade fixing screw ZK	265
EPDM façade tape	266
Silent EPDM decoupling profile	267
SonoTec, sound insulation cork	268 - 276
SonoTec Angular Decoupler	277

# Magnus hook connector

Timber connector for main / secondary beam joints



## What can it be used for?

- Load-bearing connection in carports
- Highly stressed node joints in timber engineering
- Constructional use in non-load-bearing connections e. g. in shopfitting

## Advantages

- Simple assembly
- High level of prefabrication
- Suitable for high loads
- Visible and hidden joints
- Milling cutter and milling and assembly jig available
- ESC calculation software for free preliminary calculation

## Assembly

- Always unscrew Magnus fully – simple and safe installation
- Whether it's surface-mounted or flush-mounted, the milling and assembly jig assigns a place to the connector
- The sides and end grain surfaces must be flat to avoid connector deformations due to installation

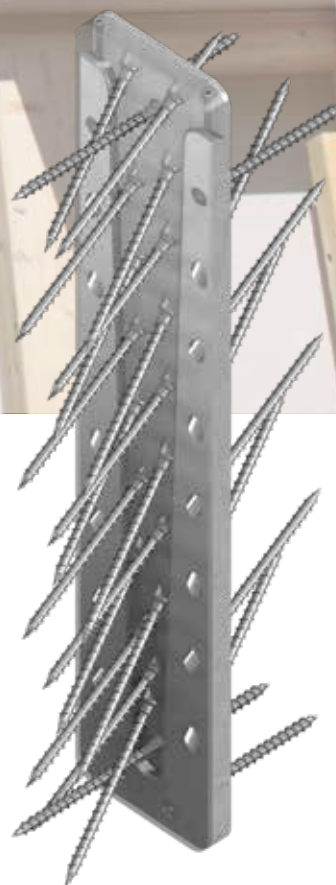



**1** Insert 90° fully threaded screws and fix Magnus to the wood

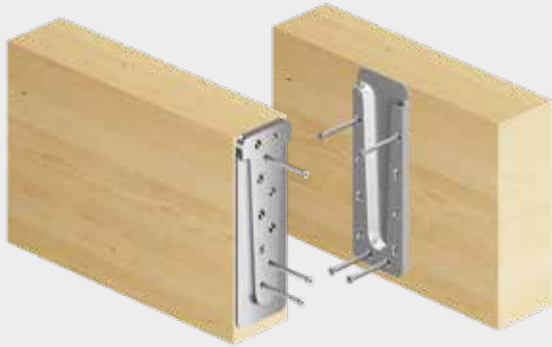

**2** Insert 45° screws

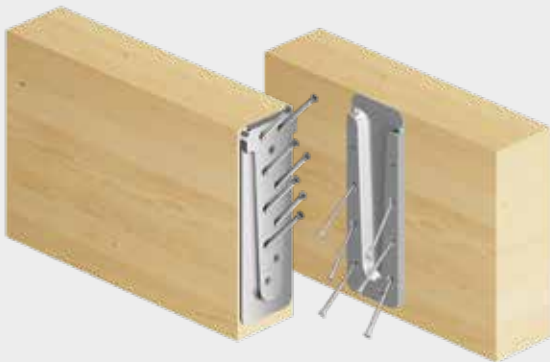

**3** Mount the secondary beam on the main beam; use fixing screws to secure the joint against lifting out

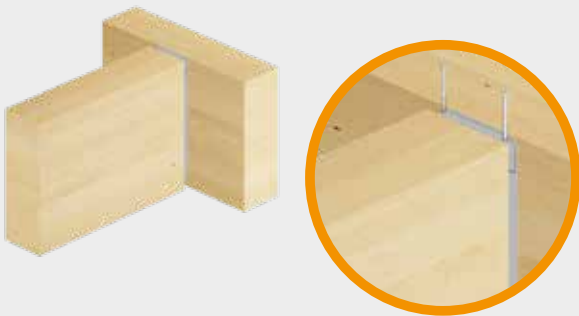

**4** Joint complete



**Connector**



**Fixing screws**



**Fully threaded screws**

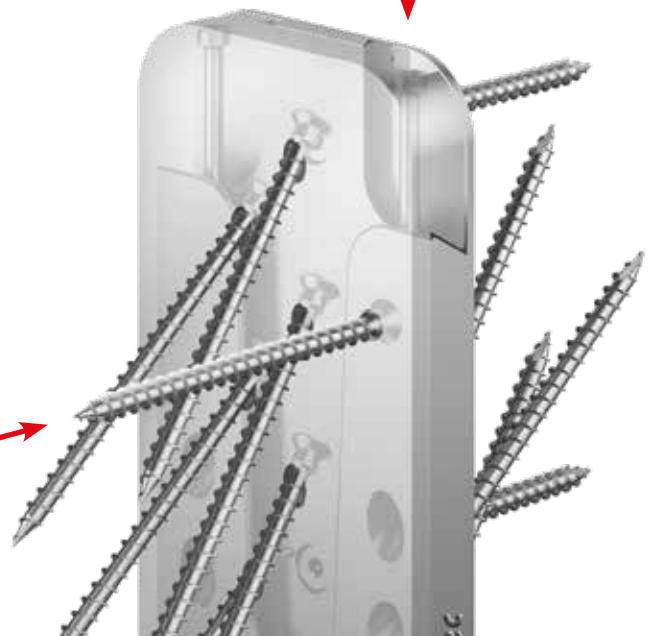

# Overview of Magnus hook connectors

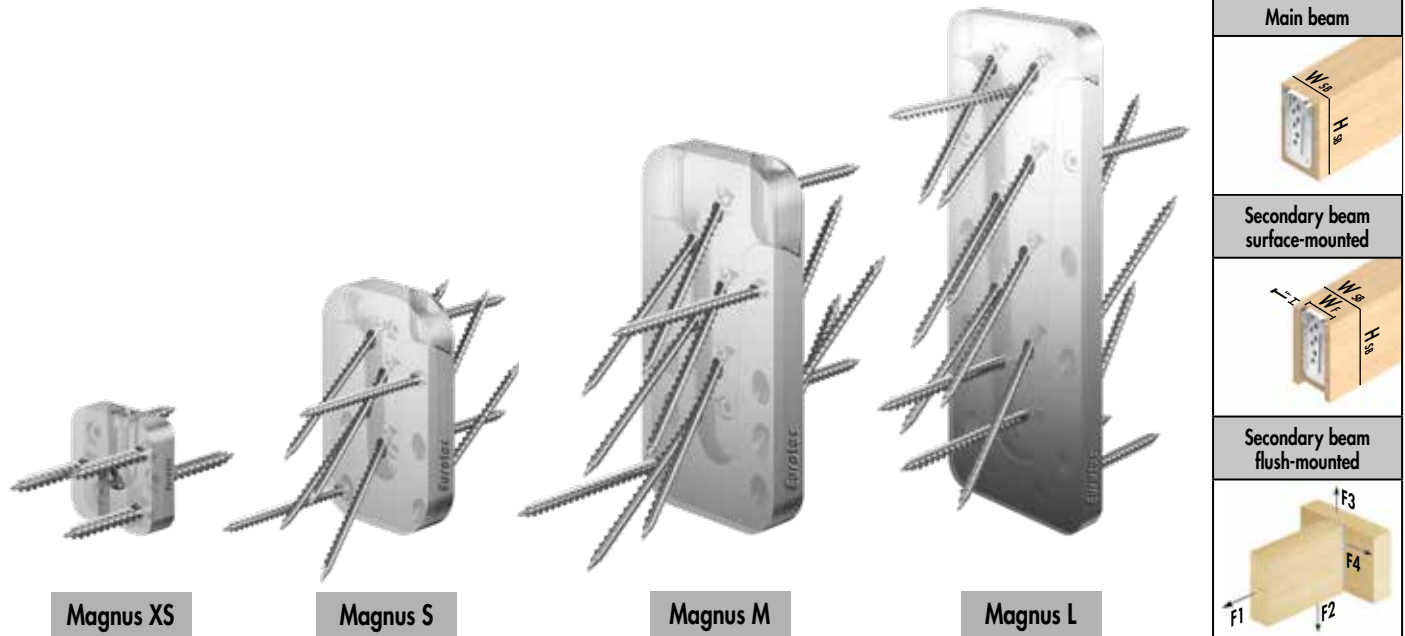

Art. no.	Name	Dimensions		PU*	Fully threaded screws <sup>b)</sup>		Fixing screws <sup>b)</sup>		Main beam		Secondary beam surface-mounted		Secondary beam flush-mounted		characteristic load-bearing capacity $F_{Rk}$ <sup>e)</sup>					
		W x H x D <sup>a)</sup>			Dimension [mm]	$n_{\text{per connector}}$	Dimension [mm]	$n_{\text{per connector}}$	min. $W_{MB}$ [mm]	min. $H_{MB}$ [mm]	min. $W_{SB}$ [mm]	min. $H_{SB}$ [mm]	min. $W_{SB}^{c)}$ [mm]	min. $H_{SB}$ [mm]	$W_F$ [mm]	$D_M^{d)}$ [mm]	$F_{1,Rk}$ [kN]	$F_{2,Rk}$ [kN]	$F_{3,Rk}$ [kN]	$F_{4,Rk}$ [kN]
		[mm]																		
944874	Magnus XS 30 x 30	30 x 30 x 9	20	4,0 x 30	6	4,2 x 26	1	40	40	40	40	40	40	30	9	1,2	1,57	1,70	1,19	
944875	Magnus S 50 x 60	50 x 60 x 13	10	4,0 x 60	8	4,2 x 26	2	60	80	60	80	80	80	50	13	3,73	7,25	5,00	1,92	
944876	Magnus S 50 x 80	50 x 80 x 13	10	4,0 x 60	12	4,2 x 26	2	60	100	60	100	80	100	50	13	3,73	14,50	5,00	2,80	
944877	Magnus S 50 x 100	50 x 100 x 13	10	4,0 x 60	18	4,2 x 26	2	60	120	60	120	80	120	50	13	7,46	21,75	5,00	4,41	
944878	Magnus M 70 x 120	70 x 120 x 17	10	5,0 x 80	13	4,8 x 60	2	80	140	80	140	100	140	70	17	5,49	21,34	13,00	5,17	
944879	Magnus M 70 x 140	70 x 140 x 17	10	5,0 x 80	16	4,8 x 60	2	80	160	80	160	100	160	70	17	5,49	32,00	13,00	6,09	
944880	Magnus M 70 x 160	70 x 160 x 17	10	5,0 x 80	21	4,8 x 60	2	80	180	80	180	100	180	70	17	10,98	37,34	13,00	8,27	
944881	Magnus M 70 x 180	70 x 180 x 17	10	5,0 x 80	24	4,8 x 60	2	80	200	80	200	100	200	70	17	10,98	42,67	13,00	9,32	
944882	Magnus L 110 x 220	110 x 220 x 19	4	8,0 x 120	13	4,8 x 60	2	120	240	120	240	140	240	110	19	9,29	36,10	23,00	13,96	
944883	Magnus L 110 x 260	110 x 260 x 19	4	8,0 x 120	17	4,8 x 60	2	120	280	120	280	140	280	110	19	13,93	45,13	23,00	17,98	
944884	Magnus L 110 x 300	110 x 300 x 19	4	8,0 x 120	20	4,8 x 60	2	120	320	120	320	140	320	110	19	13,93	54,15	23,00	20,56	
944887	Magnus L 110 x 340	110 x 340 x 19	4	8,0 x 120	22	4,8 x 60	2	120	360	120	360	140	360	110	19	13,93	63,18	23,00	24,67	
944888	Magnus L 110 x 380	110 x 380 x 19	4	8,0 x 120	25	4,8 x 60	2	120	400	120	400	140	400	110	19	9,29	72,20	23,00	26,96	
944889	Magnus L 110 x 580	110 x 580 x 19	4	8,0 x 120	38	4,8 x 60	2	120	600	120	600	140	600	110	19	9,29	126,35	23,00	43,29	

\* 1 connector consists of 2 individual parts

a) D= assembly thickness

b) Included in delivery

c) Recommended minimum width of the secondary beam with the connector flush-mounted

d) To make installation easier, it is advantageous to reduce the milling depth slightly, especially for larger wood dimensions.

e) Both beams softwood with a gross density of  $\rho_k = 380 \text{ kg/m}^3$ .

The specified characteristic values of the load-bearing capacity  $F_{Rk}$  apply to the specified timber cross-sections, centred force application along the respective beam axis as well as connector installation flush with the top edge of the main and secondary beams.

Calculation according to ETA 15/0761. All mechanical values provided should be viewed as subject to the assumptions that have been made and represent example calculations.

All values are calculated minimum values and are subject to typographical and printing errors.

The characteristic values of the load-bearing capacity  $F_{Rk}$  should not be treated as equivalent to the max. possible load (the max. force). The characteristic values of the load-bearing capacity  $F_{Rk}$  should be reduced to the design values  $F_{Ed}$  in terms of the service class and the load duration class:  $F_{Ed} = F_{Rk} \times K_{mod} / \gamma_M$ .

Please note: These are planning aids. Projects must only be calculated by authorised persons.

# Installation accessories

## Milling and assembly jig

For Magnus hook connector



- Insertion aid for surface-mounted installation
- Milling jig for flush-mounted installation

Art. no.	Suitable for	PU
944867	Magnus XS	1
944894	Magnus S	1
944895	Magnus M	1
944870	Magnus L 220/260/300	1
944903	Magnus L 340/380/420	1
944904	Magnus L 460/500/540/580	1

## Milling cutter

For Magnus hook connector



Art. no.	Suitable for	Shaft diameter [mm]	PU
944936	Magnus XS	6,35	1
29686	Magnus S	8	1
29696	Magnus M und L	8	1

### The following must be observed in the event of flush-mounted installation in the secondary beam

- The beam's minimum width must be increased so that there is enough surrounding wood remaining at the side for the milling work
- The beam must be milled out at full height

### The following must be observed in the event of flush-mounted installation in the main beam

- The main beam's load-bearing cross-section is reduced by the connector's assembly thickness
- The beam's minimum width must be adjusted (screw length)

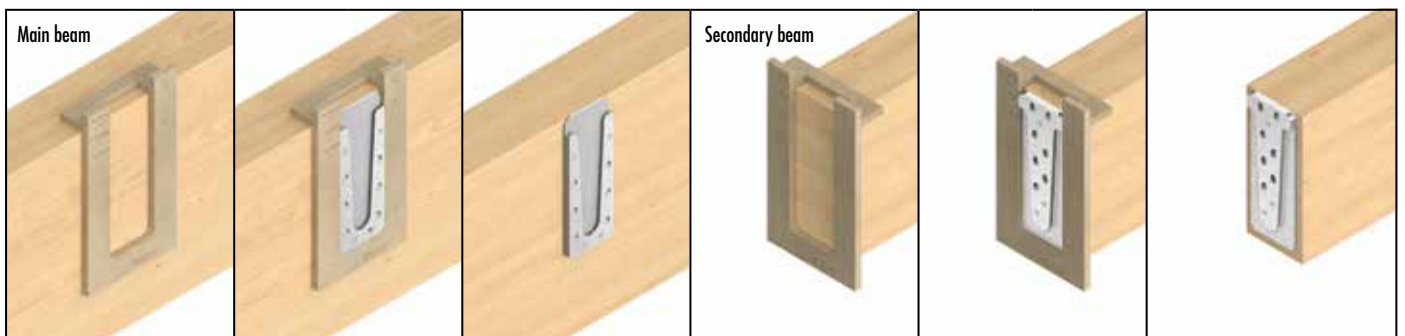

Surface-mounted installation of the Magnus hook connector: left on the main beam, right on the secondary beam

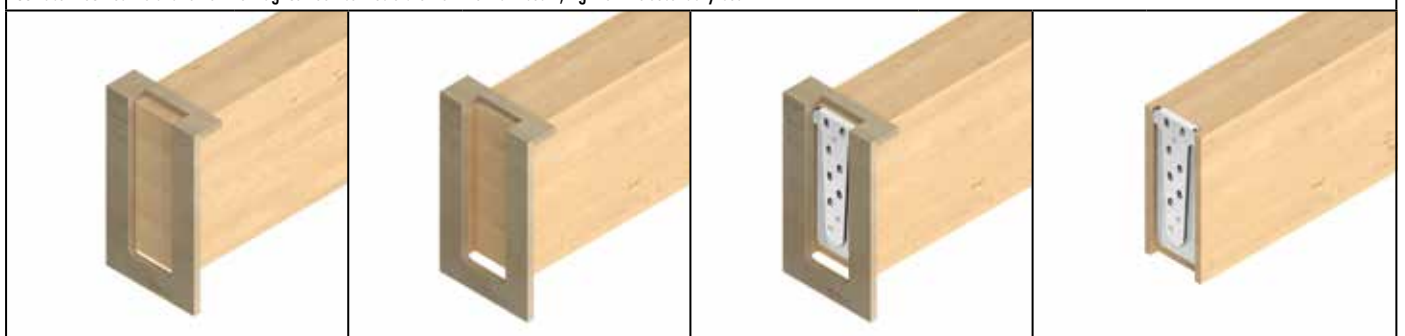

The secondary beam must be milled out at full height in the event of flush-mounted installation



# Magnus XS 30 x 30

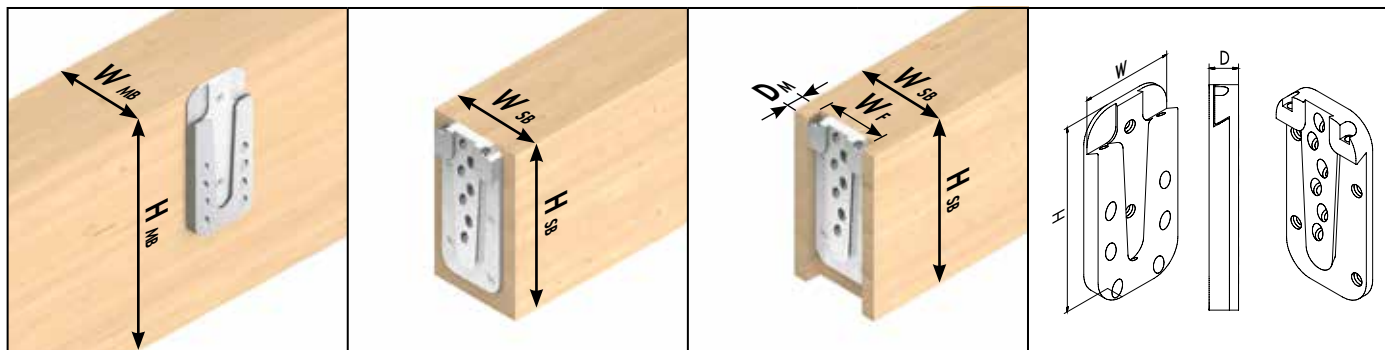

Symbolic illustrations: f.l.t.r. Main beam, secondary beam surface-mounted, secondary beam flush-mounted, connector dimensions

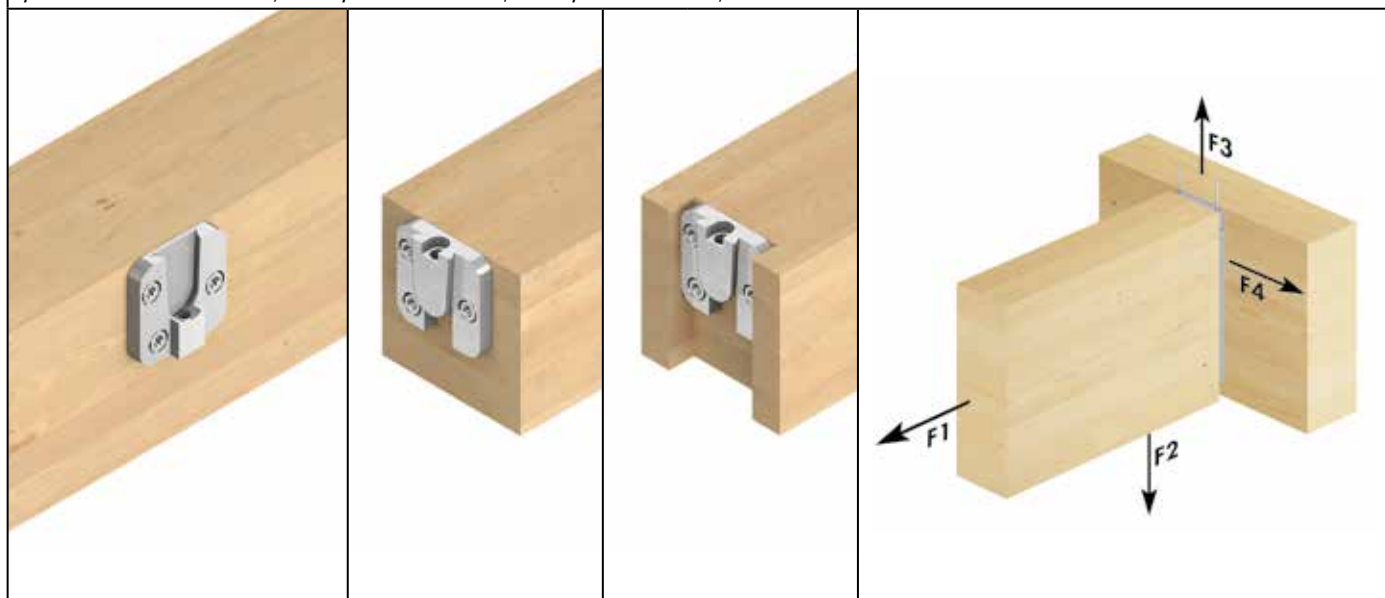

Art. no.	Name	Dimensions W x H x D <sup>a)</sup> [mm]	PU*	Fully threaded screws <sup>b)</sup>						Fixing screws <sup>b)</sup>	
				Dimensions [mm]	n <sub>total</sub>	In the main beam		In the secondary beam		Dimensions [mm]	n
						n <sub>90°</sub>	n <sub>45°</sub>	n <sub>90°</sub>	n <sub>45°</sub>		
944874	Magnus XS 30 x 30	30 x 30 x 9	20	4,0 x 30	6	3	-	3	-	4,2 x 26	1

\* 1 connector consists of 2 individual parts

a) D= assembly thickness

b) Included in delivery

Art. no.	Name	Dimensions W x H x D <sup>a)</sup> [mm]	Main beam		Secondary beam surface-mounted		Secondary beam flush-mounted				characteristic load-bearing capacity F <sub>Rk</sub> <sup>d)</sup>			
			min. W <sub>MB</sub>	min. H <sub>MB</sub>	min. W <sub>SB</sub>	min. H <sub>SB</sub>	min. W <sub>SB</sub> <sup>b)</sup>	min. H <sub>SB</sub>	W <sub>M</sub>	D <sub>M</sub> <sup>c)</sup>	F <sub>1,Rk</sub>	F <sub>2,Rk</sub>	F <sub>3,Rk</sub>	F <sub>4,Rk</sub>
			[mm]	[mm]	[mm]	[mm]	[mm]	[mm]	[mm]	[mm]	[kN]	[kN]	[kN]	[kN]
944874	Magnus XS 30 x 30	30 x 30 x 9	40	40	40	40	40	40	30	9	1,12	1,57	1,70	1,19

a) D= assembly thickness

b) Included in delivery

c) Recommended minimum width of the secondary beam with the connector flush-mounted

d) To make installation easier, it is advantageous to reduce the milling depth slightly, especially for larger wood dimensions.

e) Both beams softwood with a gross density of ρ<sub>g</sub>= 380 kg/m<sup>3</sup>.

The specified characteristic values of the load-bearing capacity F<sub>Rk</sub> apply to the specified timber cross-sections, centred force application along the respective beam axis as well as connector installation flush with the top edge of the main and secondary beams.

Calculation according to ETA 15/0761. All mechanical values provided should be viewed as subject to the assumptions that have been made and represent example calculations.

All values are calculated minimum values and are subject to typographical and printing errors.

The characteristic values of the load-bearing capacity F<sub>Rk</sub> should not be treated as equivalent to the max. possible load (the max. force). The characteristic values of the load-bearing capacity F<sub>Rk</sub> should be reduced to the design values F<sub>Ed</sub> in terms of the service class and the load duration class: F<sub>Ed</sub>= F<sub>Rk</sub> x k<sub>mod</sub> / γ<sub>M</sub>.

Please note: These are planning aids. Projects must only be calculated by authorised persons.

# Magnus S 50 x 60

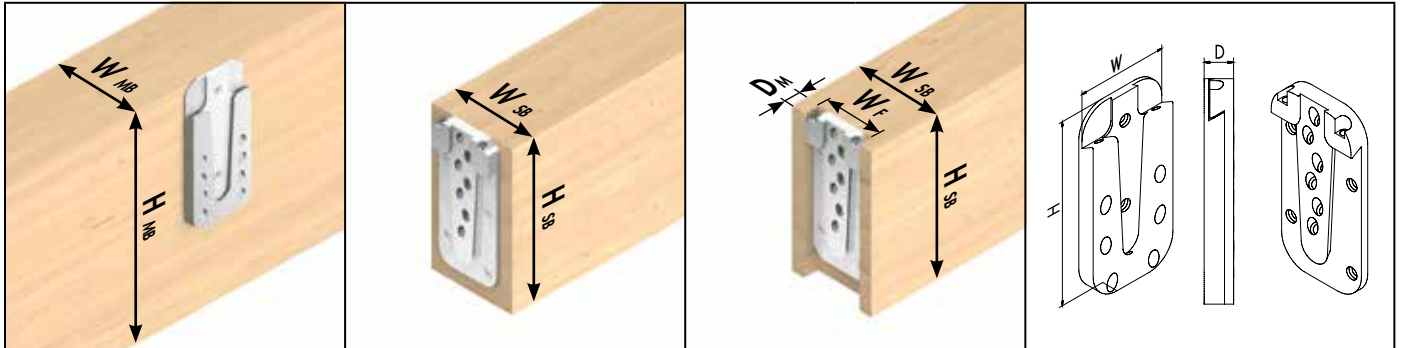

Symbolic illustrations: f.l.t.r. Main beam, secondary beam surface-mounted, secondary beam flush-mounted, connector dimensions

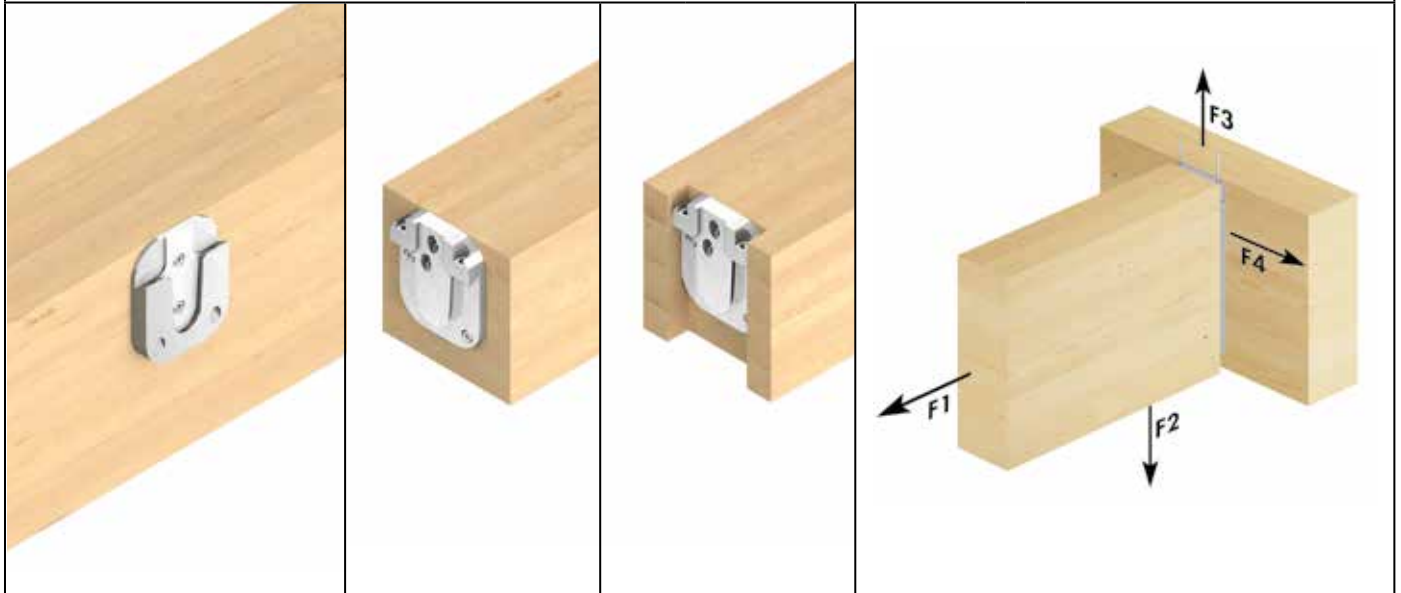

Art. no.	Name	Dimensions		PU*	Fully threaded screws <sup>b)</sup>					Fixing screws <sup>b)</sup>		
		W x H x D <sup>a)</sup>			Dimensions	n <sub>total</sub>	In the main beam		In the secondary beam		Dimensions	n
		[mm]					[mm]	n <sub>90°</sub>	n <sub>45°</sub>	n <sub>90°</sub>		
944875	Magnus S 50 x 60	50	60 x 13	10	4,0 x 60	8	2	2	2	2	4,2 x 26	2

\* 1 connector consists of 2 individual parts

a) D= assembly thickness

b) Included in delivery

Art. no.	Name	Dimensions		Main beam		Secondary beam surface-mounted		Secondary beam flush-mounted			characteristic load-bearing capacity F <sub>Rk</sub> <sup>d)</sup>				
		W x H x D <sup>a)</sup>		min. W <sub>MB</sub>	min. H <sub>MB</sub>	min. W <sub>SB</sub>	min. H <sub>SB</sub>	min. W <sub>SB</sub> <sup>b)</sup>	min. H <sub>SB</sub>	W <sub>M</sub>	D <sub>M</sub> <sup>c)</sup>	F <sub>1,Rk</sub>	F <sub>2,Rk</sub>	F <sub>3,Rk</sub>	F <sub>4,Rk</sub>
		[mm]		[mm]	[mm]	[mm]	[mm]	[mm]	[mm]	[mm]	[mm]	[kN]	[kN]	[kN]	[kN]
944875	Magnus S 50 x 60	50	60 x 13	60	80	60	80	80	80	50	13	3,73	7,25	5,00	1,92

a) D= assembly thickness

b) Included in delivery

c) Recommended minimum width of the secondary beam with the connector flush-mounted

d) To make installation easier, it is advantageous to reduce the milling depth slightly, especially for larger wood dimensions.

e) Both beams softwood with a gross density of  $\rho_k = 380 \text{ kg/m}^3$ .

The specified characteristic values of the load-bearing capacity F<sub>Rk</sub> apply to the specified timber cross-sections, centred force application along the respective beam axis as well as connector installation flush with the top edge of the main and secondary beams.

Calculation according to ETA 15/0761. All mechanical values provided should be viewed as subject to the assumptions that have been made and represent example calculations.

All values are calculated minimum values and are subject to typographical and printing errors.

The characteristic values of the load-bearing capacity F<sub>Rk</sub> should not be treated as equivalent to the max. possible load (the max. force). The characteristic values of the load-bearing capacity F<sub>Rk</sub> should be reduced to the design values F<sub>Rd</sub> in terms of the service class and the load duration class:  $F_{Rd} = F_{Rk} \times k_{mod} / \gamma_M$ .

Please note: These are planning aids. Projects must only be calculated by authorised persons.

# Magnus S 50 x 80

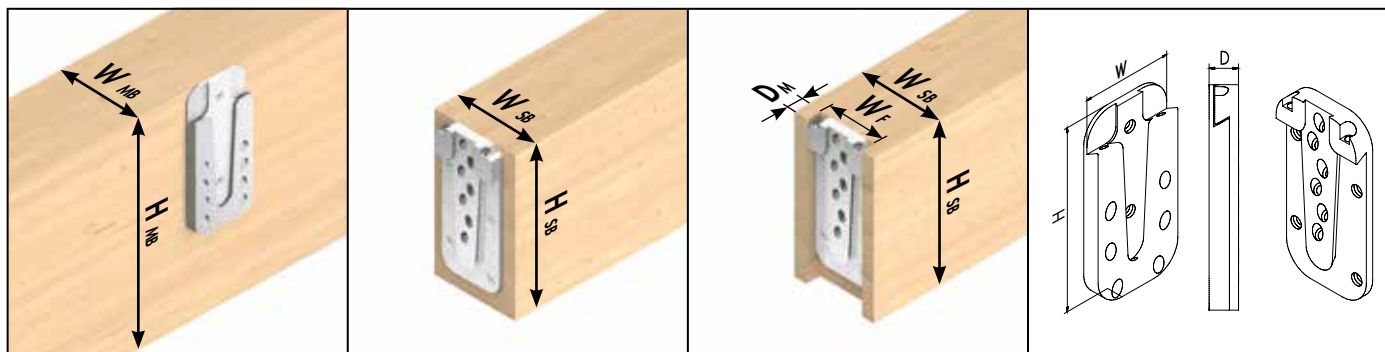

Symbolic illustrations: f.l.t.r. Main beam, secondary beam surface-mounted, secondary beam flush-mounted, connector dimensions

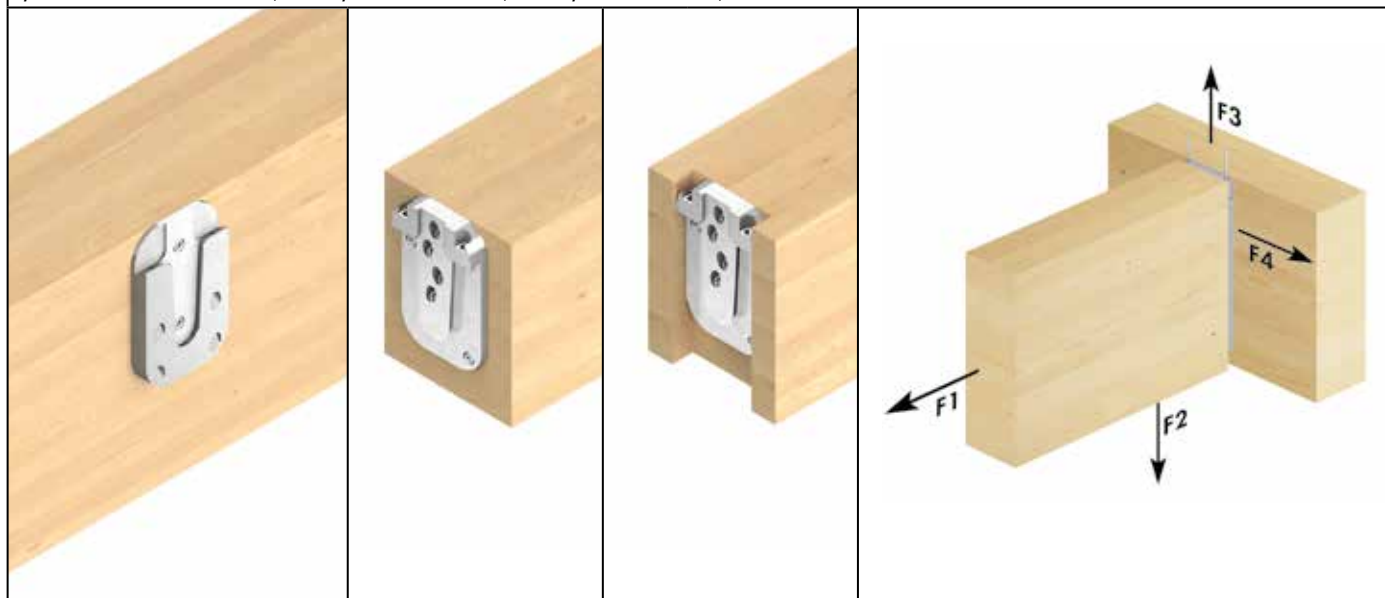

Art. no.	Name	Dimensions	PU*	Fully threaded screws <sup>b)</sup>						Fixing screws <sup>b)</sup>	
		W x H x D <sup>a)</sup>		Dimensions	n <sub>total</sub>	In the main beam		In the secondary beam		Dimensions	n
		[mm]		[mm]		n <sub>90°</sub>	n <sub>45°</sub>	n <sub>90°</sub>	n <sub>45°</sub>	[mm]	
944876	Magnus S 50 x 80	50 x 80 x 13	10	4,0 x 60	12	2	4	2	4	4,2 x 26	2

\* 1 connector consists of 2 individual parts

a) D= assembly thickness

b) Included in delivery

Art. no.	Name	Dimensions	Main beam		Secondary beam surface-mounted		Secondary beam flush-mounted			characteristic load-bearing capacity F <sub>Rk</sub> <sup>d)</sup>				
		W x H x D <sup>a)</sup>	min. W <sub>MB</sub>	min. H <sub>MB</sub>	min. W <sub>SB</sub>	min. H <sub>SB</sub>	min. W <sub>SB</sub> <sup>b)</sup>	min. H <sub>SB</sub>	W <sub>M</sub>	D <sub>M</sub> <sup>c)</sup>	F <sub>1,Rk</sub>	F <sub>2,Rk</sub>	F <sub>3,Rk</sub>	F <sub>4,Rk</sub>
		[mm]	[mm]	[mm]	[mm]	[mm]	[mm]	[mm]	[mm]	[mm]	[kN]	[kN]	[kN]	[kN]
944876	Magnus S 50 x 80	50 x 80 x 13	60	100	60	100	80	100	50	13	3,73	14,50	5,00	2,80

a) D= assembly thickness

b) Included in delivery

c) Recommended minimum width of the secondary beam with the connector flush-mounted

d) To make installation easier, it is advantageous to reduce the milling depth slightly, especially for larger wood dimensions.

e) Both beams softwood with a gross density of ρ<sub>k</sub>= 380 kg/m<sup>3</sup>.

The specified characteristic values of the load-bearing capacity F<sub>Rk</sub> apply to the specified timber cross-sections, centred force application along the respective beam axis as well as connector installation flush with the top edge of the main and secondary beams.

Calculation according to ETA 15/0761. All mechanical values provided should be viewed as subject to the assumptions that have been made and represent example calculations.

All values are calculated minimum values and are subject to typographical and printing errors.

The characteristic values of the load-bearing capacity F<sub>Rk</sub> should not be treated as equivalent to the max. possible load (the max. force). The characteristic values of the load-bearing capacity F<sub>Rk</sub> should be reduced to the design values F<sub>Ed</sub> in terms of the service class and the load duration class: F<sub>Ed</sub>= F<sub>Rk</sub> x K<sub>mod</sub> / γ<sub>M</sub>.

Please note: These are planning aids. Projects must only be calculated by authorised persons.



# Magnus S 50 x 100

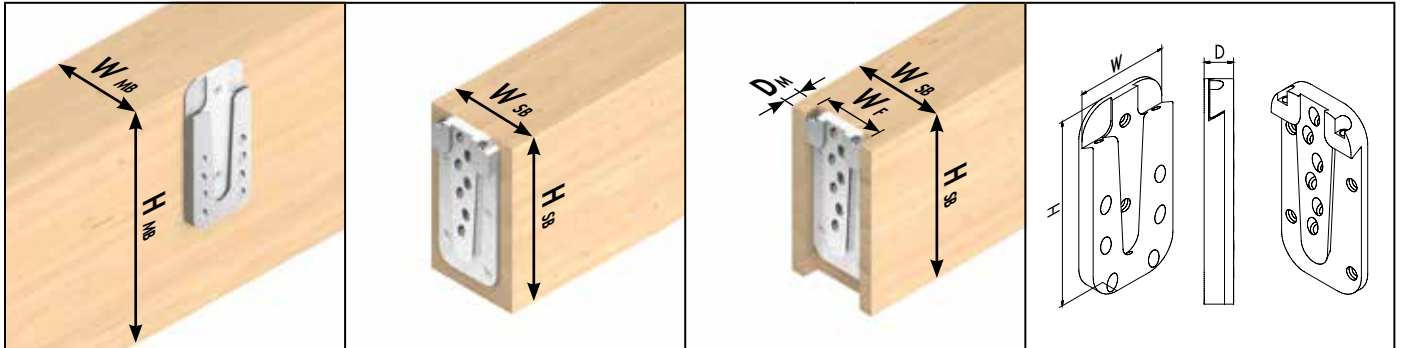

Symbolic illustrations: f.l.t.r. Main beam, secondary beam surface-mounted, secondary beam flush-mounted, connector dimensions

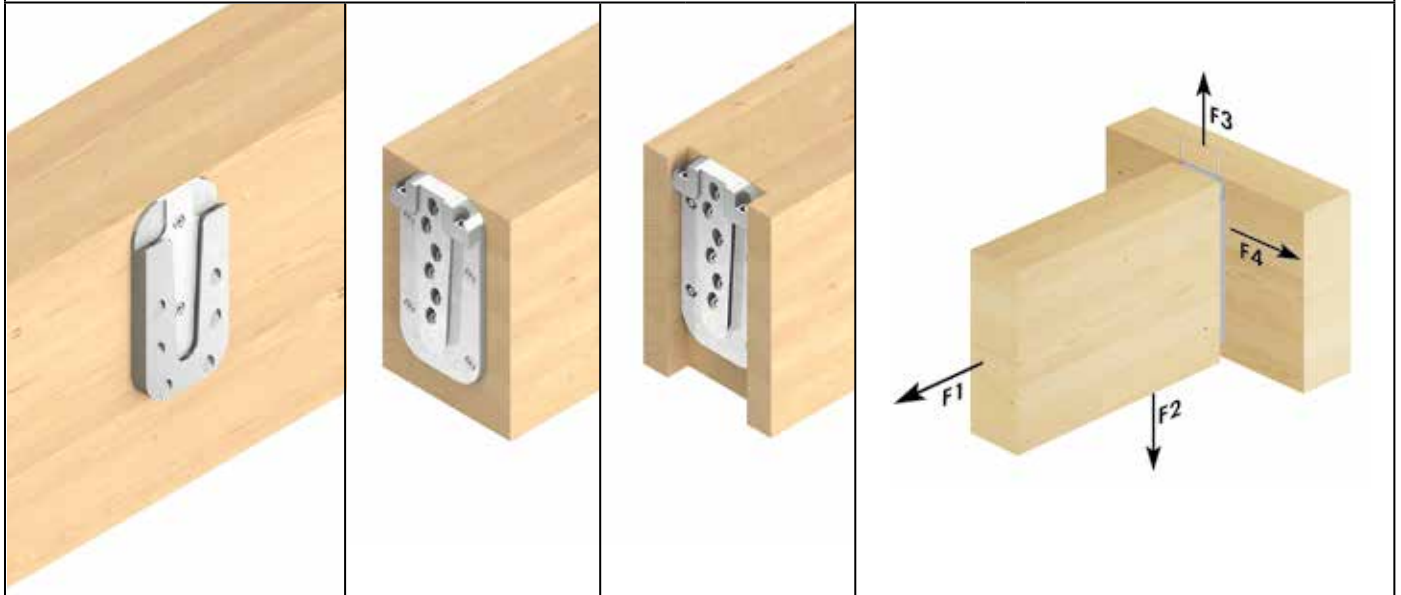

Art. no.	Name	Dimensions		PU*	Fully threaded screws <sup>b)</sup>						Fixing screws <sup>b)</sup>	
		W x H x D <sup>a)</sup>			Dimensions	n <sub>total</sub>	In the main beam		In the secondary beam		Dimensions	n
		[mm]					[mm]	n <sub>90°</sub>	n <sub>45°</sub>	n <sub>90°</sub>		
944877	Magnus S 50 x 100	50	100 x 13	10	4,0 x 60	18	2	6	4	6	4,2 x 26	2

\* 1 connector consists of 2 individual parts

a) D= assembly thickness

b) Included in delivery

Art. no.	Name	Dimensions		Main beam		Secondary beam surface-mounted		Secondary beam flush-mounted				characteristic load-bearing capacity F <sub>Rk</sub> <sup>d)</sup>			
		W x H x D <sup>a)</sup>		min. W <sub>MB</sub>	min. H <sub>MB</sub>	min. W <sub>SB</sub>	min. H <sub>SB</sub>	min. W <sub>SB</sub> <sup>b)</sup>	min. H <sub>SB</sub>	W <sub>M</sub>	D <sub>M</sub> <sup>c)</sup>	F <sub>1,Rk</sub>	F <sub>2,Rk</sub>	F <sub>3,Rk</sub>	F <sub>4,Rk</sub>
		[mm]		[mm]	[mm]	[mm]	[mm]	[mm]	[mm]	[mm]	[mm]	[kN]	[kN]	[kN]	[kN]
944877	Magnus S 50 x 100	50	100 x 13	60	120	60	120	80	120	50	13	7,46	21,75	5,00	4,41

a) D= assembly thickness

b) Included in delivery

c) Recommended minimum width of the secondary beam with the connector flush-mounted

d) To make installation easier, it is advantageous to reduce the milling depth slightly, especially for larger wood dimensions.

e) Both beams softwood with a gross density of ρ<sub>k</sub>= 380 kg/m<sup>3</sup>.

The specified characteristic values of the load-bearing capacity F<sub>Rk</sub> apply to the specified timber cross-sections, centred force application along the respective beam axis as well as connector installation flush with the top edge of the main and secondary beams.

Calculation according to ETA 15/0761. All mechanical values provided should be viewed as subject to the assumptions that have been made and represent example calculations.

All values are calculated minimum values and are subject to typographical and printing errors.

The characteristic values of the load-bearing capacity F<sub>Rk</sub> should not be treated as equivalent to the max. possible load (the max. force). The characteristic values of the load-bearing capacity F<sub>Rk</sub> should be reduced to the design values F<sub>Rd</sub> in terms of the service class and the load duration class: F<sub>Rd</sub>= F<sub>Rk</sub> x k<sub>mod</sub> / γ<sub>M</sub>.

Please note: These are planning aids. Projects must only be calculated by authorised persons.

# Magnus M 70 x 120

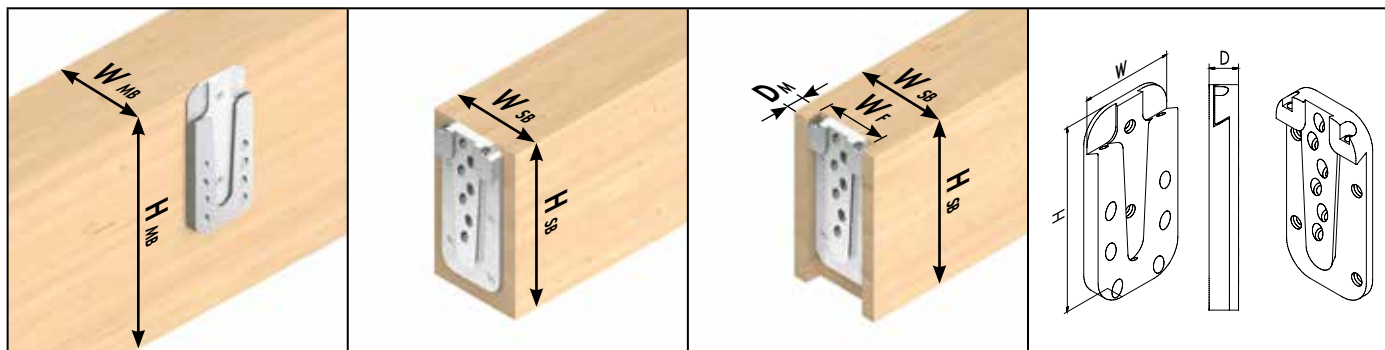

Symbolic illustrations: f.l.t.r. Main beam, secondary beam surface-mounted, secondary beam flush-mounted, connector dimensions

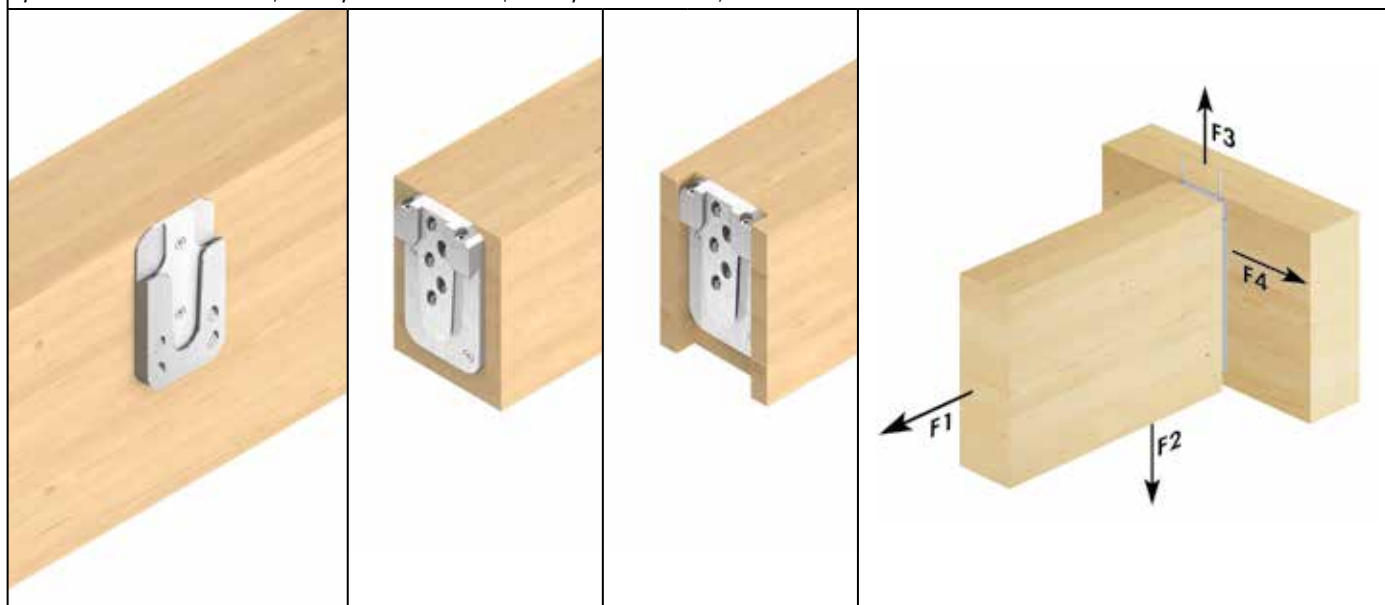

Art. no.	Name	Dimensions		PU*	Fully threaded screws <sup>b)</sup>					Fixing screws <sup>b)</sup>		
		W x H x D <sup>a)</sup>			Dimensions	n <sub>total</sub>	In the main beam		In the secondary beam		Dimensions	n
		[mm]					[mm]	n <sub>90°</sub>	n <sub>45°</sub>	n <sub>90°</sub>		
944878	Magnus M 70 x 120	70 x 120 x 17		10	5,0 x 80	13	2	4	2	5	4,8 x 60	2

\* 1 connector consists of 2 individual parts

a) D= assembly thickness

b) Included in delivery

Art. no.	Name	Dimensions	Main beam		Secondary beam surface-mounted		Secondary beam flush-mounted			characteristic load-bearing capacity F <sub>Rk</sub> <sup>d)</sup>				
		W x H x D <sup>a)</sup>	min. W <sub>MB</sub>	min. H <sub>MB</sub>	min. W <sub>SB</sub>	min. H <sub>SB</sub>	min. W <sub>SB</sub> <sup>b)</sup>	min. H <sub>SB</sub>	W <sub>M</sub>	D <sub>M</sub> <sup>c)</sup>	F <sub>1,Rk</sub>	F <sub>2,Rk</sub>	F <sub>3,Rk</sub>	F <sub>4,Rk</sub>
		[mm]	[mm]	[mm]	[mm]	[mm]	[mm]	[mm]	[mm]	[mm]	[kN]	[kN]	[kN]	[kN]
944878	Magnus M 70 x 120	70 x 120 x 17	80	140	80	140	100	140	70	17	5,49	21,34	13,00	5,17

a) D= assembly thickness

b) Included in delivery

c) Recommended minimum width of the secondary beam with the connector flush-mounted

d) To make installation easier, it is advantageous to reduce the milling depth slightly, especially for larger wood dimensions.

e) Both beams softwood with a gross density of ρ<sub>k</sub>= 380 kg/m<sup>3</sup>.

The specified characteristic values of the load-bearing capacity F<sub>Rk</sub> apply to the specified timber cross-sections, centred force application along the respective beam axis as well as connector installation flush with the top edge of the main and secondary beams.

Calculation according to ETA 15/0761. All mechanical values provided should be viewed as subject to the assumptions that have been made and represent example calculations.

All values are calculated minimum values and are subject to typographical and printing errors.

The characteristic values of the load-bearing capacity F<sub>Rk</sub> should not be treated as equivalent to the max. possible load (the max. force). The characteristic values of the load-bearing capacity F<sub>Rk</sub> should be reduced to the design values F<sub>Rd</sub> in terms of the service class and the load duration class: F<sub>Rd</sub>= F<sub>Rk</sub> x K<sub>mod</sub> / γ<sub>M</sub>.

Please note: These are planning aids. Projects must only be calculated by authorised persons.

# Magnus M 70 x 140

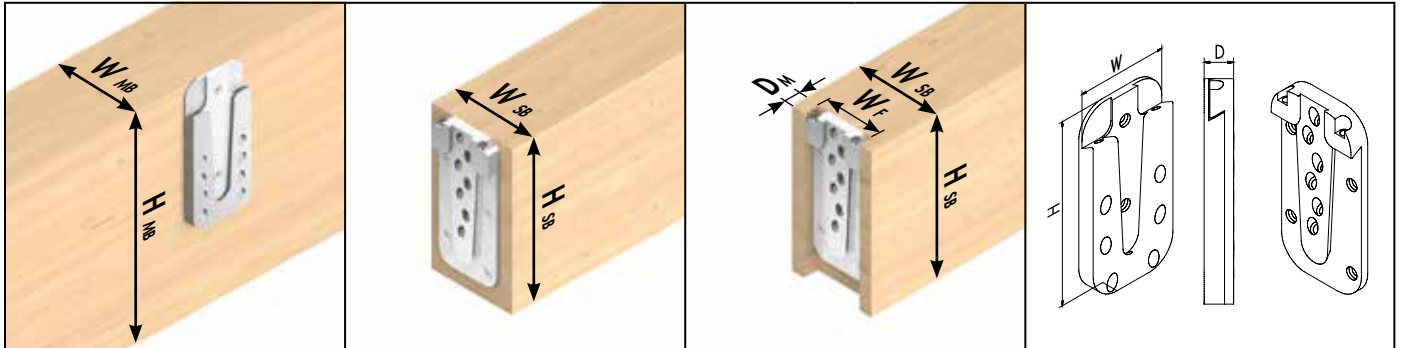

Symbolic illustrations: f.l.t.r. Main beam, secondary beam surface-mounted, secondary beam flush-mounted, connector dimensions

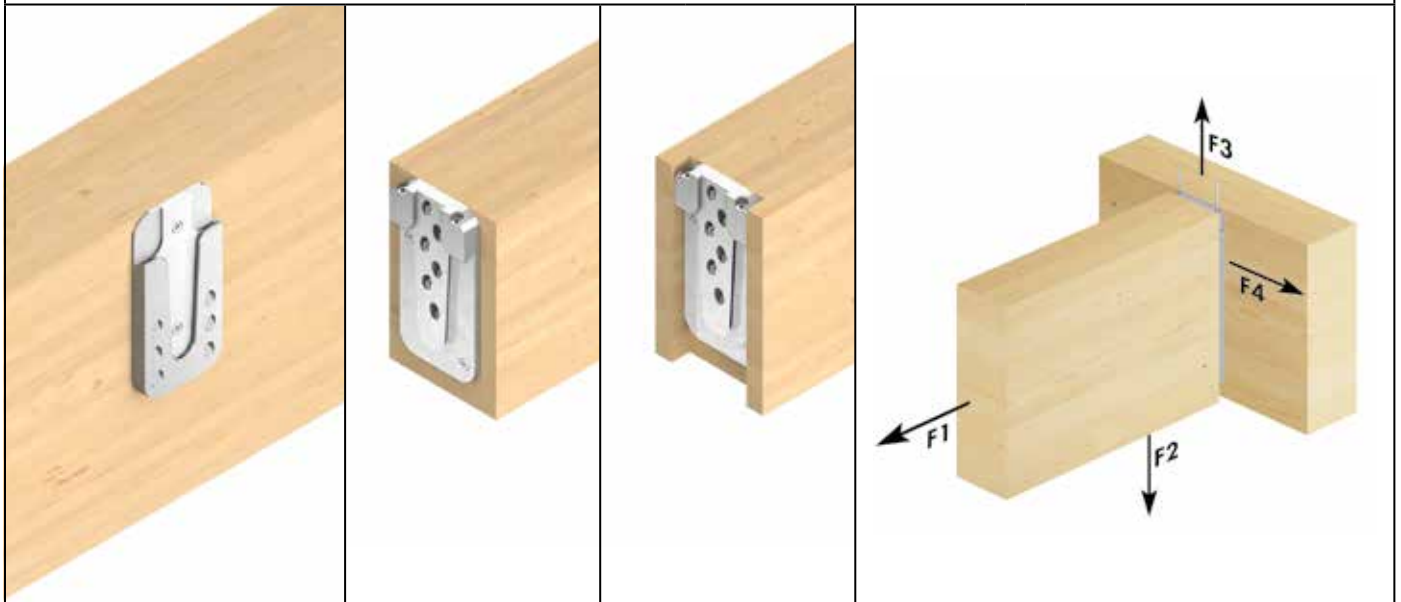

Art. no.	Name	Dimensions		PU*	Fully threaded screws <sup>b)</sup>					Fixing screws <sup>b)</sup>		
		W x H x D <sup>a)</sup>			Dimensions	n <sub>total</sub>	In the main beam		In the secondary beam		Dimensions	n
		[mm]					[mm]	n <sub>90°</sub>	n <sub>45°</sub>	n <sub>90°</sub>		
944879	Magnus M 70 x 140	70	140 x 17	10	5,0 x 80	16	2	6	2	6	4,8 x 60	2

\* 1 connector consists of 2 individual parts

a) D= assembly thickness

b) Included in delivery

Art. no.	Name	Dimensions	Main beam		Secondary beam surface-mounted		Secondary beam flush-mounted				characteristic load-bearing capacity F <sub>Rk</sub> <sup>d)</sup>			
		W x H x D <sup>a)</sup>	min. W <sub>MB</sub>	min. H <sub>MB</sub>	min. W <sub>SB</sub>	min. H <sub>SB</sub>	min. W <sub>SB</sub> <sup>b)</sup>	min. H <sub>SB</sub>	W <sub>M</sub>	D <sub>M</sub> <sup>d)</sup>	F <sub>1,Rk</sub>	F <sub>2,Rk</sub>	F <sub>3,Rk</sub>	F <sub>4,Rk</sub>
		[mm]	[mm]	[mm]	[mm]	[mm]	[mm]	[mm]	[mm]	[mm]	[kN]	[kN]	[kN]	[kN]
944879	Magnus M 70 x 140	70 x 140 x 17	80	160	80	160	100	160	70	17	5,49	32,00	13,00	6,09

a) D= assembly thickness

b) Included in delivery

c) Recommended minimum width of the secondary beam with the connector flush-mounted

d) To make installation easier, it is advantageous to reduce the milling depth slightly, especially for larger wood dimensions.

e) Both beams softwood with a gross density of ρ<sub>k</sub>= 380 kg/m<sup>3</sup>.

The specified characteristic values of the load-bearing capacity F<sub>Rk</sub> apply to the specified timber cross-sections, centred force application along the respective beam axis as well as connector installation flush with the top edge of the main and secondary beams.

Calculation according to ETA 15/0761. All mechanical values provided should be viewed as subject to the assumptions that have been made and represent example calculations.

All values are calculated minimum values and are subject to typographical and printing errors.

The characteristic values of the load-bearing capacity F<sub>Rk</sub> should not be treated as equivalent to the max. possible load (the max. force). The characteristic values of the load-bearing capacity F<sub>Rk</sub> should be reduced to the design values F<sub>Ed</sub> in terms of the service class and the load duration class: F<sub>Ed</sub>= F<sub>Rk</sub> x k<sub>mod</sub> / γ<sub>M</sub>.

Please note: These are planning aids. Projects must only be calculated by authorised persons.



# Magnus M 70 x 160

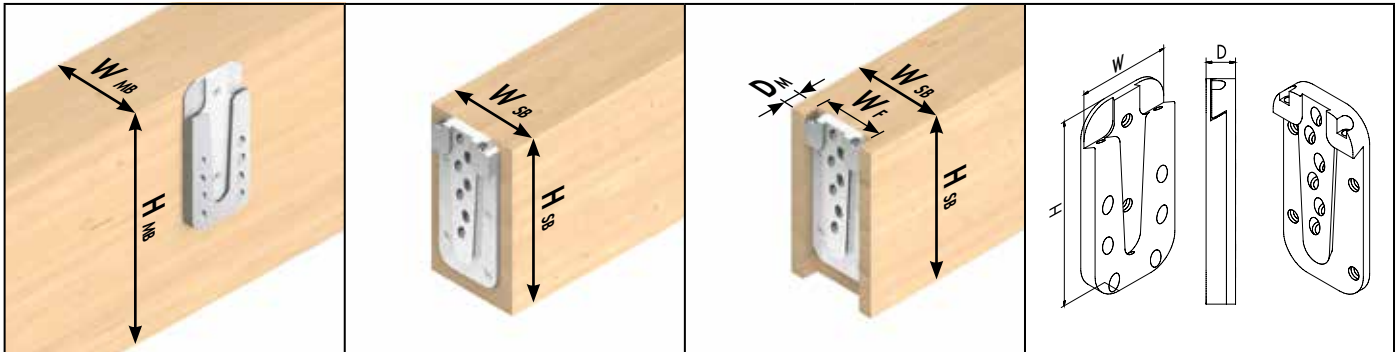

Symbolic illustrations: f.l.t.r. Main beam, secondary beam surface-mounted, secondary beam flush-mounted, connector dimensions

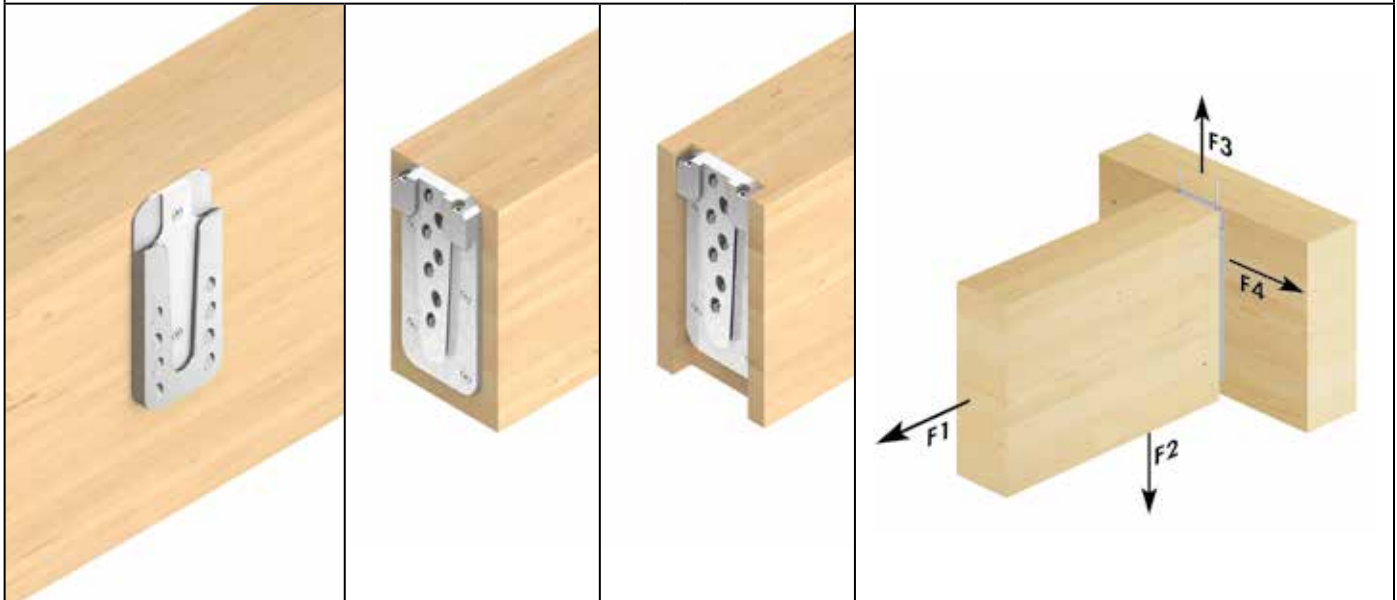

Art. no.	Name	Dimensions		PU*	Fully threaded screws <sup>b)</sup>					Fixing screws <sup>b)</sup>		
		W x H x D <sup>a)</sup>			Dimensions	n <sub>total</sub>	In the main beam		In the secondary beam		Dimensions	n
		[mm]					[mm]	n <sub>90°</sub>	n <sub>45°</sub>	n <sub>90°</sub>		
944880	Magnus M 70 x 160	70 x 160 x 17		10	5,0 x 80	21	2	8	4	7	4,8 x 60	2

\* 1 connector consists of 2 individual parts  
 a) D= assembly thickness  
 b) Included in delivery

Art. no.	Name	Dimensions	Main beam		Secondary beam surface-mounted		Secondary beam flush-mounted				characteristic load-bearing capacity F <sub>Rk</sub> <sup>d)</sup>			
		W x H x D <sup>a)</sup>	min. W <sub>MB</sub>	min. H <sub>MB</sub>	min. W <sub>SB</sub>	min. H <sub>SB</sub>	min. W <sub>SB</sub> <sup>b)</sup>	min. H <sub>SB</sub>	W <sub>M</sub>	D <sub>M</sub> <sup>c)</sup>	F <sub>1,Rk</sub>	F <sub>2,Rk</sub>	F <sub>3,Rk</sub>	F <sub>4,Rk</sub>
		[mm]	[mm]	[mm]	[mm]	[mm]	[mm]	[mm]	[mm]	[mm]	[kN]	[kN]	[kN]	[kN]
944880	Magnus M 70 x 160	70 x 160 x 17	80	180	80	180	100	180	70	17	10,98	37,34	13,00	8,27

a) D= assembly thickness  
 b) Included in delivery  
 c) Recommended minimum width of the secondary beam with the connector flush-mounted  
 d) To make installation easier, it is advantageous to reduce the milling depth slightly, especially for larger wood dimensions.  
 e) Both beams softwood with a gross density of ρ<sub>k</sub>= 380 kg/m<sup>3</sup>.  
 The specified characteristic values of the load-bearing capacity F<sub>Rk</sub> apply to the specified timber cross-sections, centred force application along the respective beam axis as well as connector installation flush with the top edge of the main and secondary beams. Calculation according to ETA 15/0761. All mechanical values provided should be viewed as subject to the assumptions that have been made and represent example calculations.  
 All values are calculated minimum values and are subject to typographical and printing errors.  
 The characteristic values of the load-bearing capacity F<sub>Rk</sub> should not be treated as equivalent to the max. possible load (the max. force). The characteristic values of the load-bearing capacity F<sub>Rk</sub> should be reduced to the design values F<sub>Rd</sub> in terms of the service class and the load duration class: F<sub>Rd</sub>= F<sub>Rk</sub> x K<sub>mod</sub> / γ<sub>M</sub>.  
 Please note: These are planning aids. Projects must only be calculated by authorised persons.

# Magnus M 70 x 180

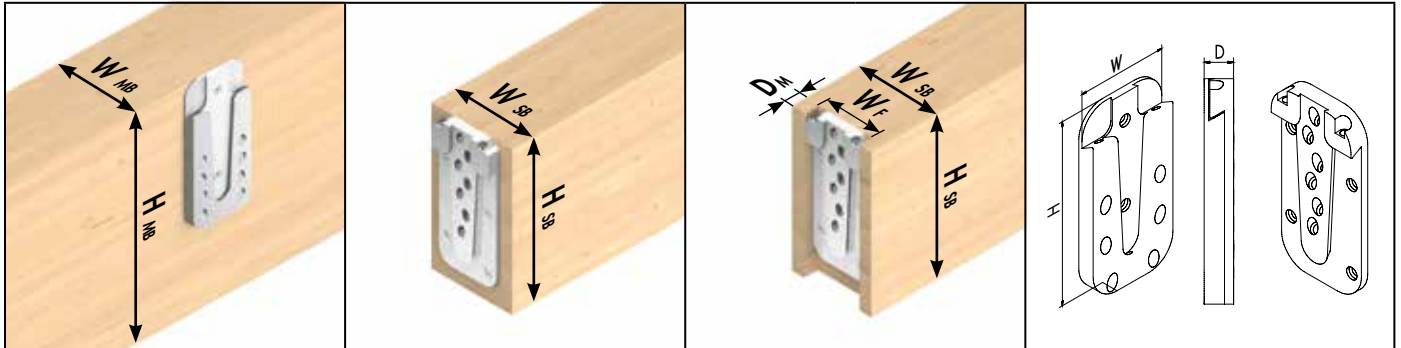

Symbolic illustrations: f.l.t.r. Main beam, secondary beam surface-mounted, secondary beam flush-mounted, connector dimensions

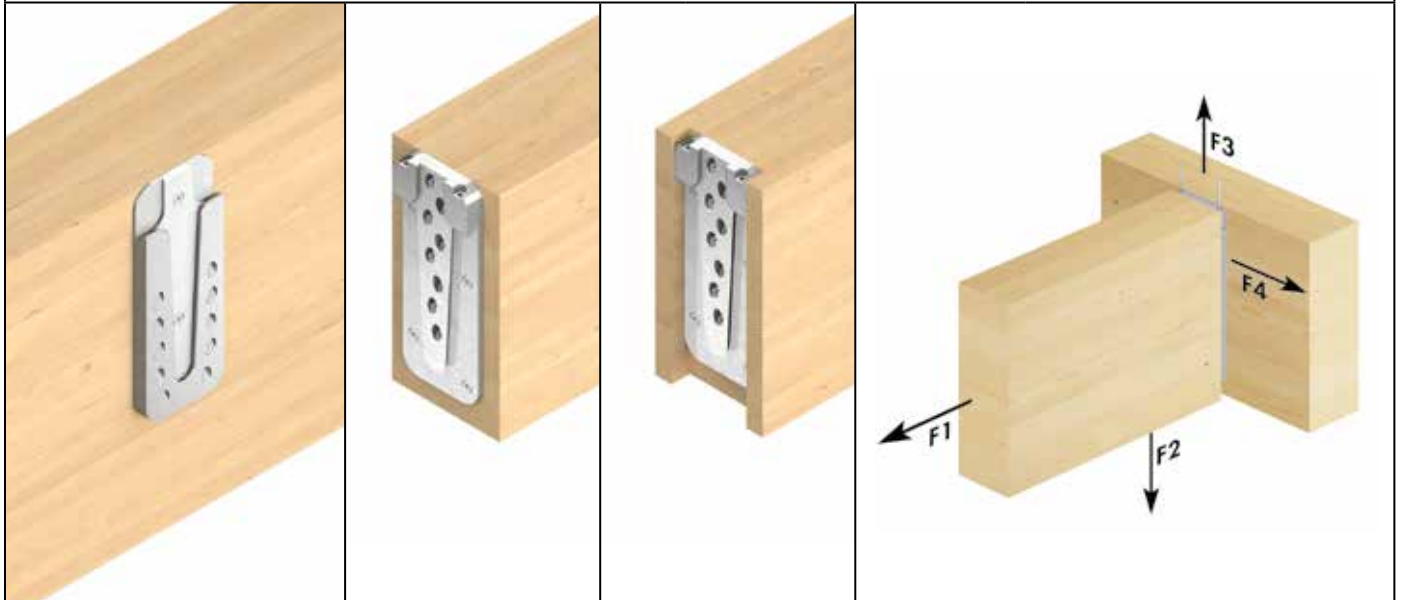

Art. no.	Name	Dimensions		PU*	Fully threaded screws <sup>b)</sup>					Fixing screws <sup>b)</sup>		
		W x H x D <sup>a)</sup>			Dimensions	n <sub>total</sub>	In the main beam		In the secondary beam		Dimensions	n
		[mm]					[mm]	n <sub>90°</sub>	n <sub>45°</sub>	n <sub>90°</sub>		
944881	Magnus M 70 x 180	70	180	17	5,0 x 80	24	2	10	4	8	4,8 x 60	2

\* 1 connector consists of 2 individual parts

a) D= assembly thickness

b) Included in delivery

Art. no.	Name	Dimensions	Main beam		Secondary beam surface-mounted		Secondary beam flush-mounted				characteristic load-bearing capacity F <sub>Rk</sub> <sup>d)</sup>			
		W x H x D <sup>a)</sup>	min. W <sub>MB</sub>	min. H <sub>MB</sub>	min. W <sub>SB</sub>	min. H <sub>SB</sub>	min. W <sub>SB</sub> <sup>b)</sup>	min. H <sub>SB</sub>	W <sub>M</sub>	D <sub>M</sub> <sup>c)</sup>	F <sub>1,Rk</sub>	F <sub>2,Rk</sub>	F <sub>3,Rk</sub>	F <sub>4,Rk</sub>
		[mm]	[mm]	[mm]	[mm]	[mm]	[mm]	[mm]	[mm]	[mm]	[kN]	[kN]	[kN]	[kN]
944881	Magnus M 70 x 180	70 x 180 x 17	80	200	80	200	100	200	70	17	10,98	42,67	13,00	9,32

a) D= assembly thickness

b) Included in delivery

c) Recommended minimum width of the secondary beam with the connector flush-mounted

d) To make installation easier, it is advantageous to reduce the milling depth slightly, especially for larger wood dimensions.

e) Both beams softwood with a gross density of ρ<sub>0k</sub> = 380 kg/m<sup>3</sup>.

The specified characteristic values of the load-bearing capacity F<sub>Rk</sub> apply to the specified timber cross-sections, centred force application along the respective beam axis as well as connector installation flush with the top edge of the main and secondary beams. Calculation according to ETA 15/0761. All mechanical values provided should be viewed as subject to the assumptions that have been made and represent example calculations.

All values are calculated minimum values and are subject to typographical and printing errors.

The characteristic values of the load-bearing capacity F<sub>Rk</sub> should not be treated as equivalent to the max. possible load (the max. force). The characteristic values of the load-bearing capacity F<sub>Rk</sub> should be reduced to the design values F<sub>Rd</sub> in terms of the service class and the load duration class: F<sub>Rd</sub> = F<sub>Rk</sub> × K<sub>mod</sub> / γ<sub>M</sub>.

Please note: These are planning aids. Projects must only be calculated by authorised persons.

# Magnus L 110 x 220

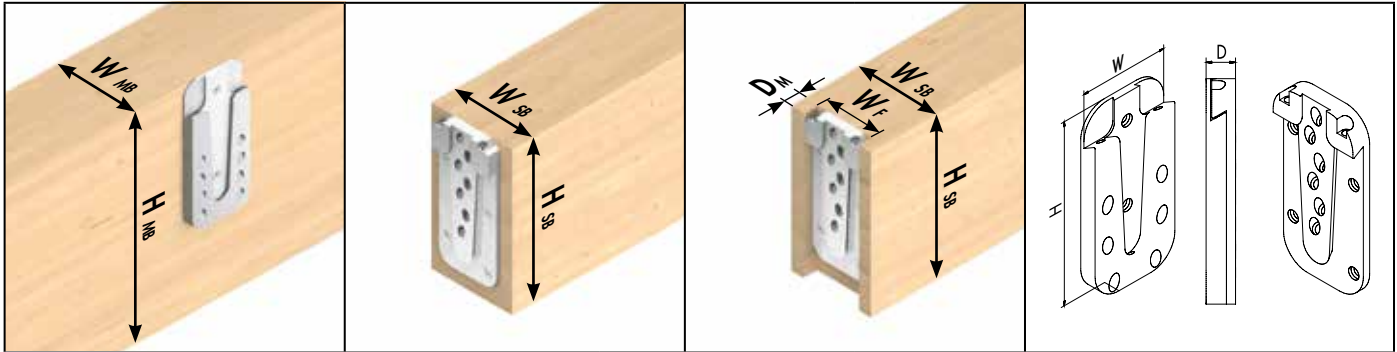

Symbolic illustrations: f.l.t.r. Main beam, secondary beam surface-mounted, secondary beam flush-mounted, connector dimensions

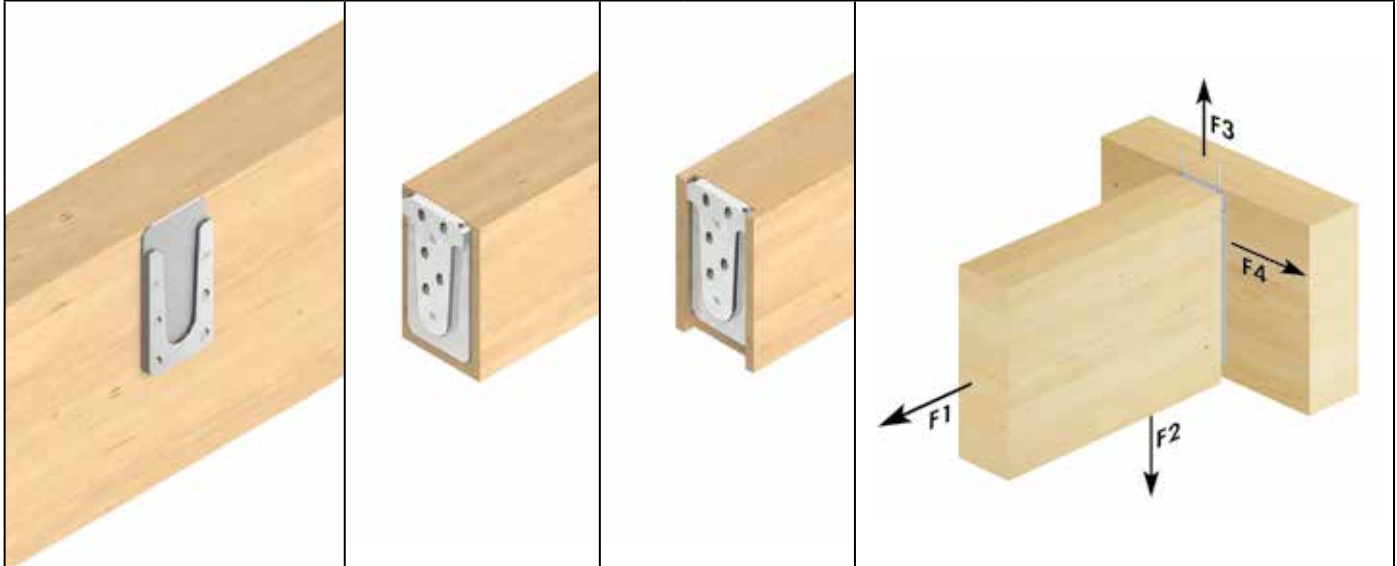

Art. no.	Name	Dimensions	PU*	Fully threaded screws <sup>b)</sup>						Fixing screws <sup>b)</sup>	
		W x H x D <sup>a)</sup>		Dimensions [mm]	n <sub>total</sub>	In the main beam		In the secondary beam		Dimensions [mm]	n
		[mm]				n <sub>90°</sub>	n <sub>45°</sub>	n <sub>90°</sub>	n <sub>45°</sub>		
944882	Magnus L 110 x 220	110 x 220 x 19	4	8,0 x 120	13	2	4	2	5	4,8 x 60	2

\* 1 connector consists of 2 individual parts

a) D= assembly thickness

b) Included in delivery

Art. no.	Name	Dimensions	Main beam		Secondary beam surface-mounted		Secondary beam flush-mounted		characteristic load-bearing capacity F <sub>Rk</sub> <sup>d)</sup>					
		W x H x D <sup>a)</sup>	min. W <sub>MB</sub>	min. H <sub>MB</sub>	min. W <sub>SB</sub>	min. H <sub>SB</sub>	min. W <sub>SB</sub> <sup>b)</sup>	min. H <sub>SB</sub>	W <sub>M</sub>	D <sub>M</sub> <sup>c)</sup>	F <sub>1,Rk</sub>	F <sub>2,Rk</sub>	F <sub>3,Rk</sub>	F <sub>4,Rk</sub>
		[mm]	[mm]	[mm]	[mm]	[mm]	[mm]	[mm]	[mm]	[mm]	[kN]	[kN]	[kN]	[kN]
944882	Magnus L 110 x 220	110 x 220 x 19	120	240	120	240	140	240	110	19	9,29	36,10	23,00	13,96

a) D= assembly thickness

b) Included in delivery

c) Recommended minimum width of the secondary beam with the connector flush-mounted

d) To make installation easier, it is advantageous to reduce the milling depth slightly, especially for larger wood dimensions.

e) Both beams softwood with a gross density of ρ<sub>k</sub>= 380 kg/m<sup>3</sup>.

The specified characteristic values of the load-bearing capacity F<sub>Rk</sub> apply to the specified timber cross-sections, centred force application along the respective beam axis as well as connector installation flush with the top edge of the main and secondary beams. Calculation according to ETA 15/0761. All mechanical values provided should be viewed as subject to the assumptions that have been made and represent example calculations.

All values are calculated minimum values and are subject to typographical and printing errors.

The characteristic values of the load-bearing capacity F<sub>Rk</sub> should not be treated as equivalent to the max. possible load (the max. force). The characteristic values of the load-bearing capacity F<sub>Rk</sub> should be reduced to the design values F<sub>Ed</sub> in terms of the service class and the load duration class: F<sub>Ed</sub>= F<sub>Rk</sub> X k<sub>mod</sub> / γ<sub>M</sub>.

The characteristic load-bearing capacities for the L series were determined using 8 x 120 VG screws. Higher capacities can be achieved with longer screws (however, the minimum cross-sections of the supports also change)

Please note: These are planning aids. Projects must only be calculated by authorised persons.



# Magnus L 110 x 260

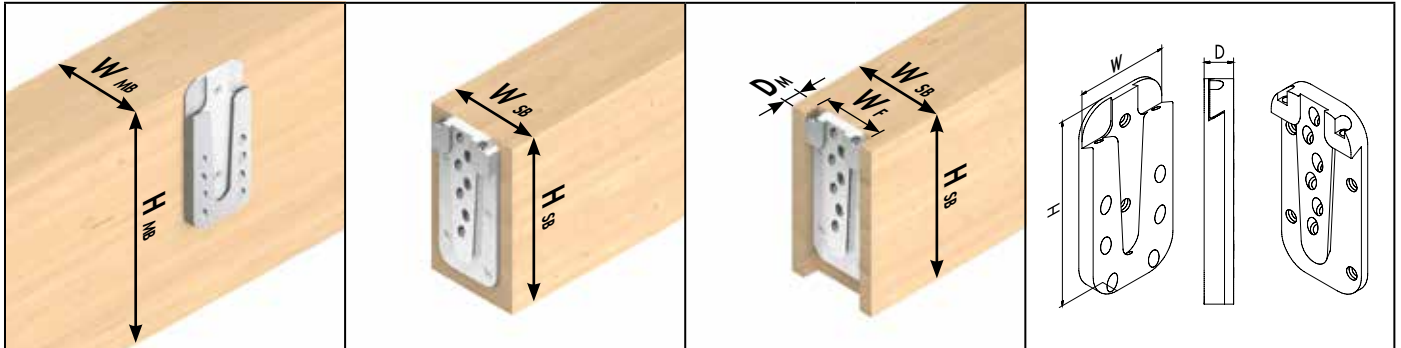

Symbolic illustrations: f.l.t.r. Main beam, secondary beam surface-mounted, secondary beam flush-mounted, connector dimensions

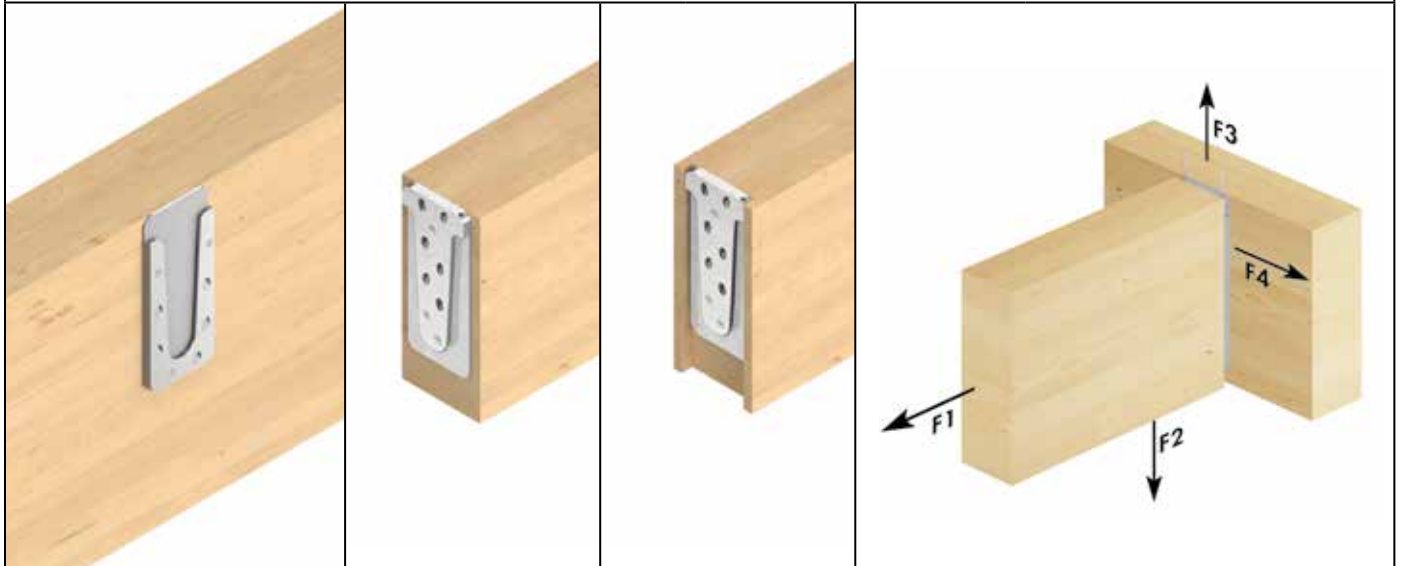

Art. no.	Name	Dimensions	PU*	Fully threaded screws <sup>b)</sup>						Fixing screws <sup>b)</sup>	
		W x H x D <sup>a)</sup>		Dimensions [mm]	n <sub>total</sub>	In the main beam		In the secondary beam		Dimensions	n
		[mm]				[mm]	n <sub>90°</sub>	n <sub>45°</sub>	n <sub>90°</sub>	n <sub>45°</sub>	
944883	Magnus L 110 x 260	110 x 260 x 19	4	8,0 x 120	17	3	5	3	6	4,8 x 60	2

\* 1 connector consists of 2 individual parts

a) D= assembly thickness

b) Included in delivery

Art. no.	Name	Dimensions	Main beam		Secondary beam surface-mounted		Secondary beam flush-mounted				characteristic load-bearing capacity F <sub>Rk</sub> <sup>d)</sup>			
		W x H x D <sup>a)</sup>	min. W <sub>MB</sub>	min. H <sub>MB</sub>	min. W <sub>SB</sub>	min. H <sub>SB</sub>	min. W <sub>SB</sub> <sup>b)</sup>	min. H <sub>SB</sub>	W <sub>M</sub>	D <sub>M</sub> <sup>c)</sup>	F <sub>1,Rk</sub>	F <sub>2,Rk</sub>	F <sub>3,Rk</sub>	F <sub>4,Rk</sub>
		[mm]	[mm]	[mm]	[mm]	[mm]	[mm]	[mm]	[mm]	[mm]	[kN]	[kN]	[kN]	[kN]
944883	Magnus L 110 x 260	110 x 260 x 19	120	280	120	280	140	280	110	19	13,93	45,13	23,00	17,98

a) D= assembly thickness

b) Included in delivery

c) Recommended minimum width of the secondary beam with the connector flush-mounted

d) To make installation easier, it is advantageous to reduce the milling depth slightly, especially for larger wood dimensions.

e) Both beams softwood with a gross density of  $\rho_k = 380 \text{ kg/m}^3$ .

The specified characteristic values of the load-bearing capacity F<sub>Rk</sub> apply to the specified timber cross-sections, centred force application along the respective beam axis as well as connector installation flush with the top edge of the main and secondary beams. Calculation according to ETA 15/0761. All mechanical values provided should be viewed as subject to the assumptions that have been made and represent example calculations.

All values are calculated minimum values and are subject to typographical and printing errors.

The characteristic values of the load-bearing capacity F<sub>Rk</sub> should not be treated as equivalent to the max. possible load (the max. force). The characteristic values of the load-bearing capacity F<sub>Rk</sub> should be reduced to the design values F<sub>Rd</sub> in terms of the service class and the load duration class:  $F_{Rd} = F_{Rk} \times k_{mod} / \gamma_M$ .

The characteristic load-bearing capacities for the L series were determined using 8 x 120 VG screws. Higher capacities can be achieved with longer screws (however, the minimum cross-sections of the supports also change)

Please note: These are planning aids. Projects must only be calculated by authorised persons.

# Magnus L 110 x 300

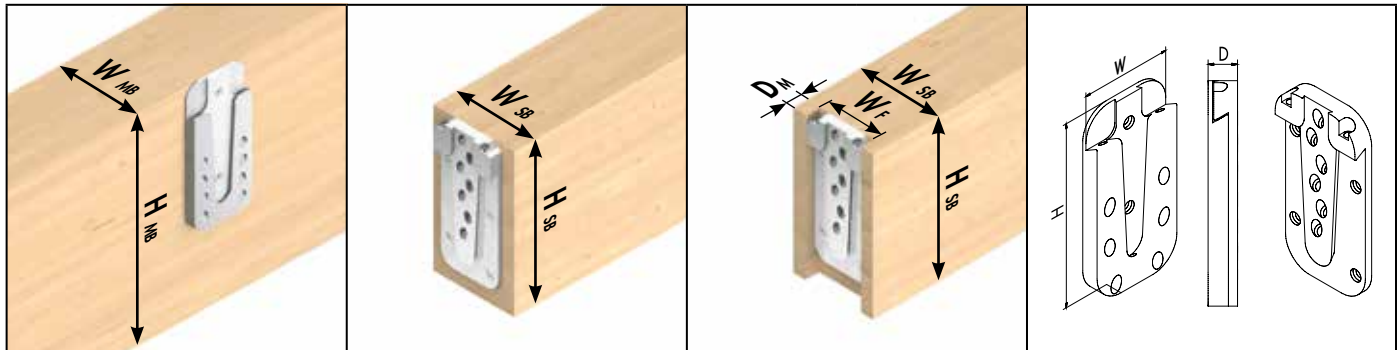

Symbolic illustrations: f.l.t.r. Main beam, secondary beam surface-mounted, secondary beam flush-mounted, connector dimensions

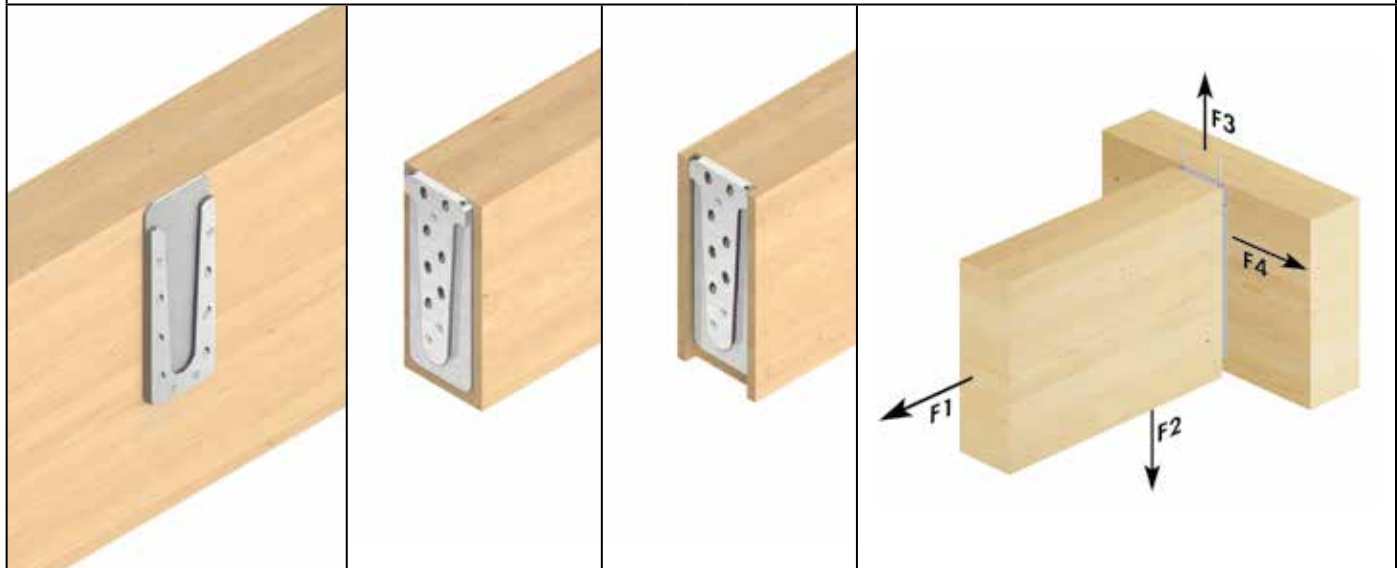

Art. no.	Name	Dimensions		PU*	Fully threaded screws <sup>b)</sup>						Fixing screws <sup>b)</sup>			
		W x H x D <sup>a)</sup>			Dimensions		n <sub>total</sub>	In the main beam		In the secondary beam		Dimensions		
		[mm]			[mm]			n <sub>90°</sub>	n <sub>45°</sub>	n <sub>90°</sub>	n <sub>45°</sub>	[mm]		n
944884	Magnus L 110 x 300	110 x 300 x 19		4	8,0 x 120		20	4	6	3	7	4,8 x 60		2

\* 1 connector consists of 2 individual parts

a) D= assembly thickness

b) Included in delivery

Art. no.	Name	Dimensions		Main beam		Secondary beam surface-mounted		Secondary beam flush-mounted		characteristic load-bearing capacity F <sub>Rk</sub> <sup>d)</sup>					
		W x H x D <sup>a)</sup>		min. W <sub>MB</sub>	min. H <sub>MB</sub>	min. W <sub>SB</sub>	min. H <sub>SB</sub>	min. W <sub>SB</sub> <sup>b)</sup>	min. H <sub>SB</sub>	W <sub>M</sub>	D <sub>M</sub> <sup>c)</sup>	F <sub>1,Rk</sub>	F <sub>2,Rk</sub>	F <sub>3,Rk</sub>	F <sub>4,Rk</sub>
		[mm]		[mm]	[mm]	[mm]	[mm]	[mm]	[mm]	[mm]	[mm]	[kN]	[kN]	[kN]	[kN]
944884	Magnus L 110 x 300	110 x 300 x 19		120	320	120	320	140	320	110	19	13,93	54,15	23,00	20,56

a) D= assembly thickness

b) Included in delivery

c) Recommended minimum width of the secondary beam with the connector flush-mounted

d) To make installation easier, it is advantageous to reduce the milling depth slightly, especially for larger wood dimensions.

e) Both beams softwood with a gross density of ρ<sub>k</sub>= 380 kg/m<sup>3</sup>.

The specified characteristic values of the load-bearing capacity F<sub>Rk</sub> apply to the specified timber cross-sections, centred force application along the respective beam axis as well as connector installation flush with the top edge of the main and secondary beams. Calculation according to ETA 15/0761. All mechanical values provided should be viewed as subject to the assumptions that have been made and represent example calculations.

All values are calculated minimum values and are subject to typographical and printing errors.

The characteristic values of the load-bearing capacity F<sub>Rk</sub> should not be treated as equivalent to the max. possible load (the max. force). The characteristic values of the load-bearing capacity F<sub>Rk</sub> should be reduced to the design values F<sub>Ed</sub> in terms of the service class and the load duration class: F<sub>Ed</sub>= F<sub>Rk</sub> x k<sub>mod</sub> / γ<sub>M</sub>.

The characteristic load-bearing capacities for the L series were determined using 8 x 120 VG screws. Higher capacities can be achieved with longer screws (however, the minimum cross-sections of the supports also change)

Please note: These are planning aids. Projects must only be calculated by authorised persons.

# Magnus L 110 x 340

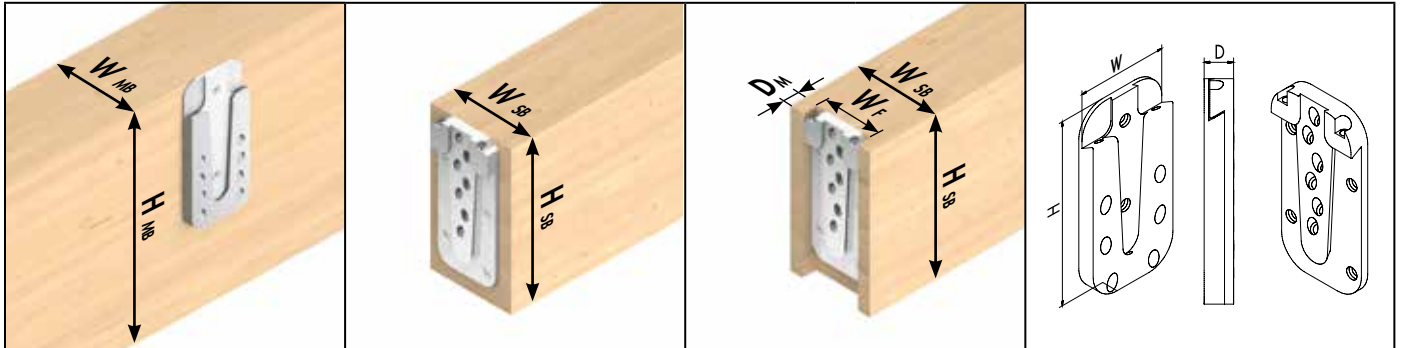

Symbolic illustrations: f.l.t.r. Main beam, secondary beam surface-mounted, secondary beam flush-mounted, connector dimensions

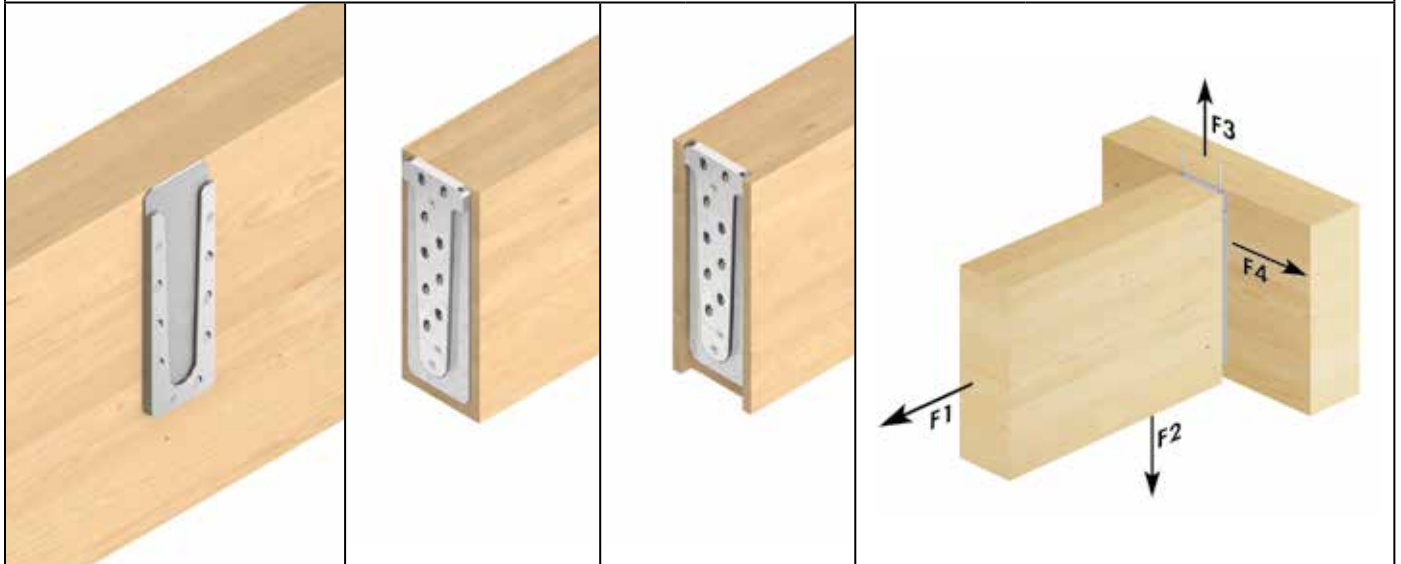

Art. no.	Name	Dimensions		PU*	Fully threaded screws <sup>b)</sup>					Fixing screws <sup>b)</sup>		
		W x H x D <sup>a)</sup>			Dimensions	n <sub>total</sub>	In the main beam		In the secondary beam		Dimensions	n
		[mm]					[mm]	n <sub>90°</sub>	n <sub>45°</sub>	n <sub>90°</sub>		
944887	Magnus L 110 x 340	110	340 x 19	4	8,0 x 120	22	3	7	3	9	4,8 x 60	2

\* 1 connector consists of 2 individual parts

a) D= assembly thickness

b) Included in delivery

Art. no.	Name	Dimensions		Main beam		Secondary beam surface-mounted		Secondary beam flush-mounted			characteristic load-bearing capacity F <sub>Rk</sub> <sup>d)</sup>				
		W x H x D <sup>a)</sup>		min. W <sub>MB</sub>	min. H <sub>MB</sub>	min. W <sub>SB</sub>	min. H <sub>SB</sub>	min. W <sub>SB</sub> <sup>b)</sup>	min. H <sub>SB</sub>	W <sub>M</sub>	D <sub>M</sub> <sup>c)</sup>	F <sub>1,Rk</sub>	F <sub>2,Rk</sub>	F <sub>3,Rk</sub>	F <sub>4,Rk</sub>
		[mm]		[mm]	[mm]	[mm]	[mm]	[mm]	[mm]	[mm]	[mm]	[kN]	[kN]	[kN]	[kN]
944887	Magnus L 110 x 340	110	340 x 19	120	360	120	360	140	360	110	19	13,93	63,18	23,00	24,67

a) D= assembly thickness

b) Included in delivery

c) Recommended minimum width of the secondary beam with the connector flush-mounted

d) To make installation easier, it is advantageous to reduce the milling depth slightly, especially for larger wood dimensions.

e) Both beams softwood with a gross density of  $\rho_k = 380 \text{ kg/m}^3$ .

The specified characteristic values of the load-bearing capacity F<sub>Rk</sub> apply to the specified timber cross-sections, centred force application along the respective beam axis as well as connector installation flush with the top edge of the main and secondary beams. Calculation according to ETA 15/0761. All mechanical values provided should be viewed as subject to the assumptions that have been made and represent example calculations.

All values are calculated minimum values and are subject to typographical and printing errors.

The characteristic values of the load-bearing capacity F<sub>Rk</sub> should not be treated as equivalent to the max. possible load (the max. force). The characteristic values of the load-bearing capacity F<sub>Rk</sub> should be reduced to the design values F<sub>Ed</sub> in terms of the service class and the load duration class:  $F_{Ed} = F_{Rk} \times k_{mod} / \gamma_M$ .

The characteristic load-bearing capacities for the L series were determined using 8 x 120 VG screws. Higher capacities can be achieved with longer screws (however, the minimum cross-sections of the supports also change)

Please note: These are planning aids. Projects must only be calculated by authorised persons.



# Magnus L 110 x 380

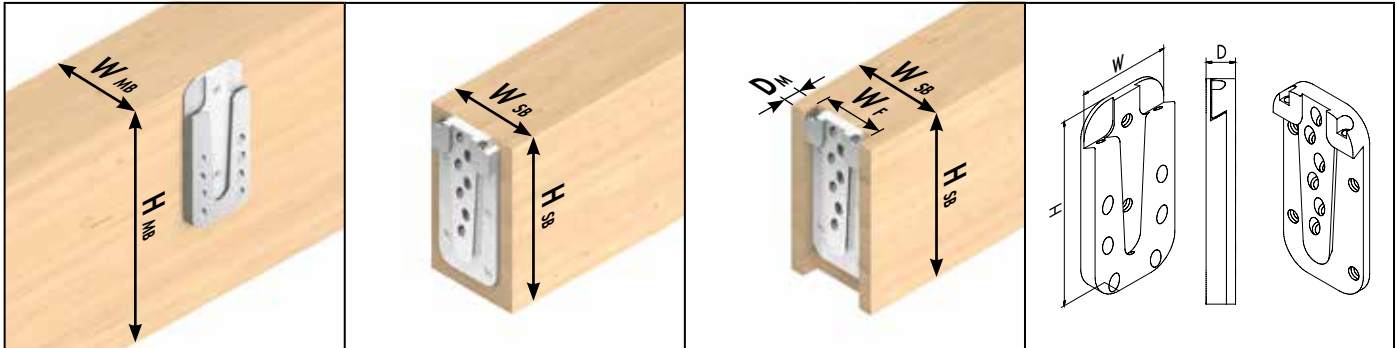

Symbolic illustrations: f.l.t.r. Main beam, secondary beam surface-mounted, secondary beam flush-mounted, connector dimensions

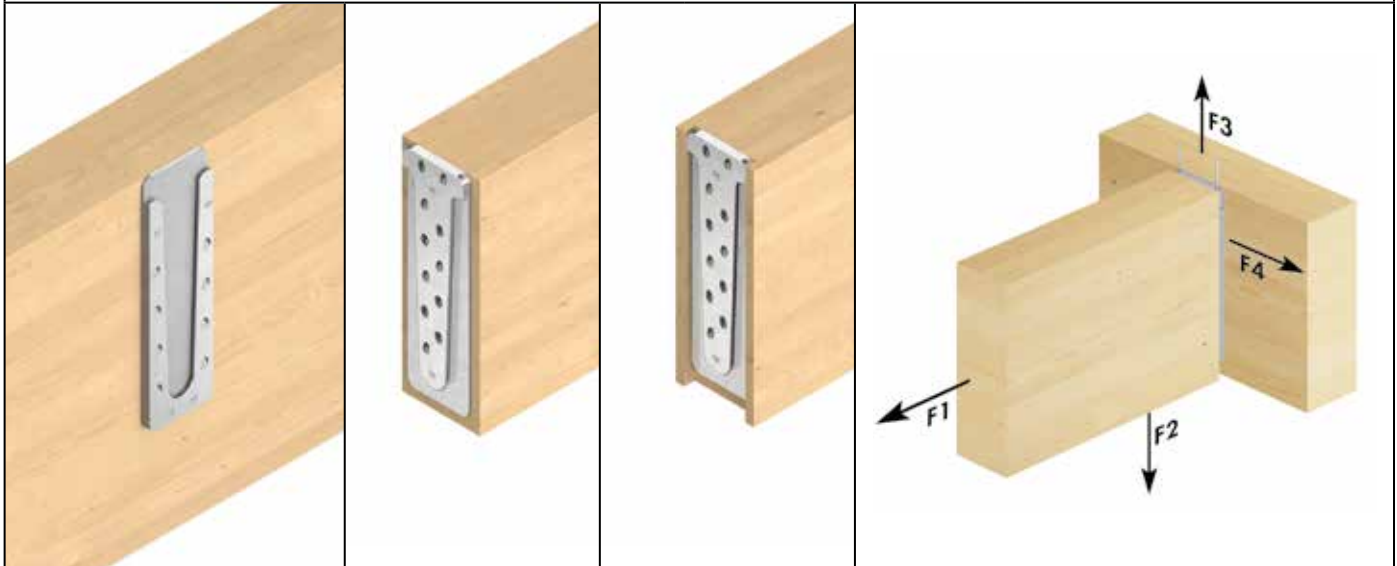

Art. no.	Name	Dimensions		PU*	Fully threaded screws <sup>b)</sup>					Fixing screws <sup>b)</sup>		
		W x H x D <sup>a)</sup>			Dimensions [mm]	n <sub>total</sub>	In the main beam		In the secondary beam		Dimensions [mm]	n
		[mm]					n <sub>90°</sub>	n <sub>45°</sub>	n <sub>90°</sub>	n <sub>45°</sub>		
944888	Magnus L 110 x 380	110 x 380 x 19		4	8,0 x 120	25	4	8	2	11	4,8 x 60	2

\* 1 connector consists of 2 individual parts

a) D= assembly thickness

b) Included in delivery

Art. no.	Name	Dimensions	Main beam		Secondary beam surface-mounted		Secondary beam flush-mounted			characteristic load-bearing capacity F <sub>Rk</sub> <sup>d)</sup>				
		W x H x D <sup>a)</sup>	min. W <sub>MB</sub>	min. H <sub>MB</sub>	min. W <sub>SB</sub>	min. H <sub>SB</sub>	min. W <sub>SB</sub> <sup>b)</sup>	min. H <sub>SB</sub>	W <sub>M</sub>	D <sub>M</sub> <sup>c)</sup>	F <sub>1,Rk</sub>	F <sub>2,Rk</sub>	F <sub>3,Rk</sub>	F <sub>4,Rk</sub>
		[mm]	[mm]	[mm]	[mm]	[mm]	[mm]	[mm]	[mm]	[mm]	[kN]	[kN]	[kN]	[kN]
944888	Magnus L 110 x 380	110 x 380 x 19	120	400	120	400	140	400	110	19	9,29	72,20	23,00	26,96

a) D= assembly thickness

b) Included in delivery

c) Recommended minimum width of the secondary beam with the connector flush-mounted

d) To make installation easier, it is advantageous to reduce the milling depth slightly, especially for larger wood dimensions.

e) Both beams softwood with a gross density of ρ<sub>k</sub>= 380 kg/m<sup>3</sup>.

The specified characteristic values of the load-bearing capacity F<sub>Rk</sub> apply to the specified timber cross-sections, centred force application along the respective beam axis as well as connector installation flush with the top edge of the main and secondary beams. Calculation according to ETA 15/0761. All mechanical values provided should be viewed as subject to the assumptions that have been made and represent example calculations.

All values are calculated minimum values and are subject to typographical and printing errors.

The characteristic values of the load-bearing capacity F<sub>Rk</sub> should not be treated as equivalent to the max. possible load (the max. force). The characteristic values of the load-bearing capacity F<sub>Rk</sub> should be reduced to the design values F<sub>Ed</sub> in terms of the service class and the load duration class: F<sub>Ed</sub>= F<sub>Rk</sub> x k<sub>mod</sub> / γ<sub>M</sub>.

The characteristic load-bearing capacities for the L series were determined using 8 x 120 VG screws. Higher capacities can be achieved with longer screws (however, the minimum cross-sections of the supports also change)

Please note: These are planning aids. Projects must only be calculated by authorised persons.

# Magnus L 110 x 580

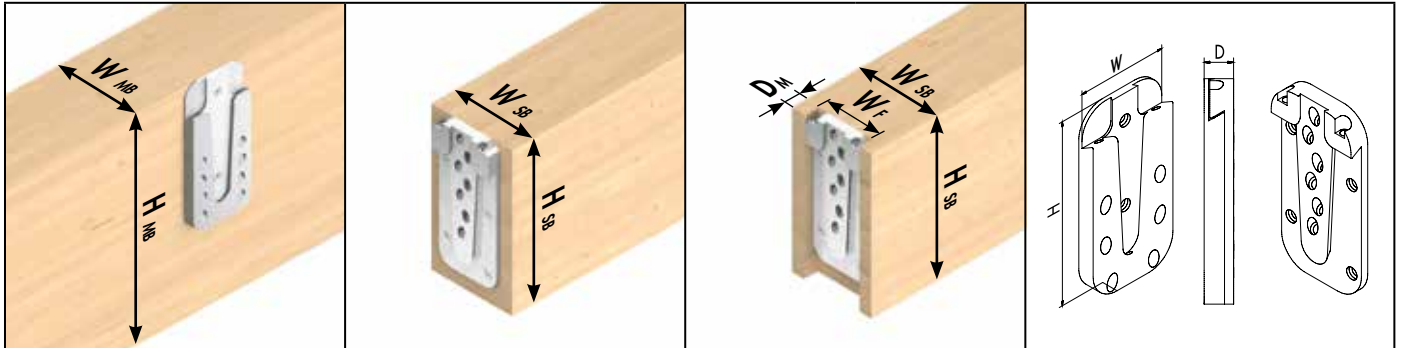

Symbolic illustrations: f.l.t.r. Main beam, secondary beam surface-mounted, secondary beam flush-mounted, connector dimensions

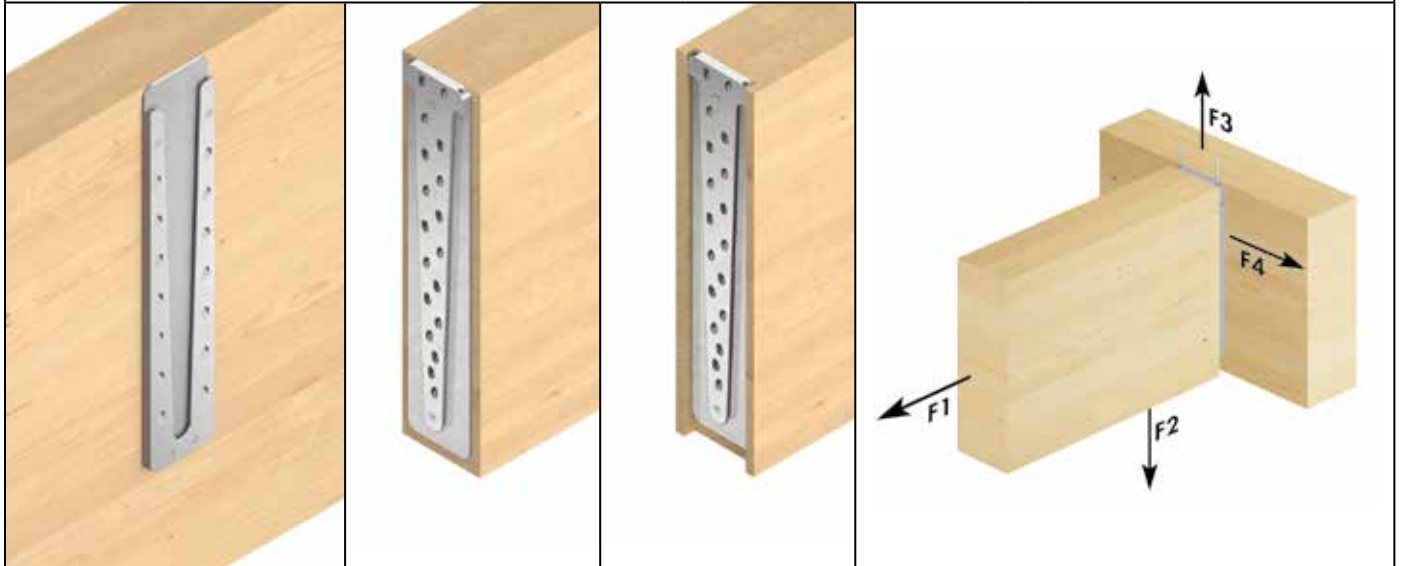

Art. no.	Name	Dimensions		PU*	Fully threaded screws <sup>b)</sup>					Fixing screws <sup>b)</sup>		
		W x H x D <sup>a)</sup>			Dimensions	n <sub>total</sub>	In the main beam		In the secondary beam		Dimensions	n
		[mm]					[mm]	n <sub>90°</sub>	n <sub>45°</sub>	n <sub>90°</sub>		
944889	Magnus L 110 x 580	110 x 580 x 19	4	8,0 x 120	38	4	14	2	18	4,8 x 60	2	

\* 1 connector consists of 2 individual parts

a) D= assembly thickness

b) Included in delivery

Art. no.	Name	Dimensions		Main beam		Secondary beam surface-mounted		Secondary beam flush-mounted		characteristic load-bearing capacity F <sub>Rk</sub> <sup>d)</sup>					
		W x H x D <sup>a)</sup>		min. W <sub>MB</sub>	min. H <sub>MB</sub>	min. W <sub>SB</sub>	min. H <sub>SB</sub>	min. W <sub>SB</sub> <sup>b)</sup>	min. H <sub>SB</sub>	W <sub>M</sub>	D <sub>M</sub> <sup>c)</sup>	F <sub>1,Rk</sub>	F <sub>2,Rk</sub>	F <sub>3,Rk</sub>	F <sub>4,Rk</sub>
		[mm]		[mm]	[mm]	[mm]	[mm]	[mm]	[mm]	[mm]	[mm]	[kN]	[kN]	[kN]	[kN]
944889	Magnus L 110 x 580	110 x 580 x 19	120	600	120	600	140	600	110	19	9,29	126,35	23,00	43,29	

a) D= assembly thickness

b) Included in delivery

c) Recommended minimum width of the secondary beam with the connector flush-mounted

d) To make installation easier, it is advantageous to reduce the milling depth slightly, especially for larger wood dimensions.

e) Both beams softwood with a gross density of ρ<sub>k</sub>= 380 kg/m<sup>3</sup>.

The specified characteristic values of the load-bearing capacity F<sub>Rk</sub> apply to the specified timber cross-sections, centred force application along the respective beam axis as well as connector installation flush with the top edge of the main and secondary beams. Calculation according to ETA 15/0761. All mechanical values provided should be viewed as subject to the assumptions that have been made and represent example calculations.

All values are calculated minimum values and are subject to typographical and printing errors.

The characteristic values of the load-bearing capacity F<sub>Rk</sub> should not be treated as equivalent to the max. possible load (the max. force). The characteristic values of the load-bearing capacity F<sub>Rk</sub> should be reduced to the design values F<sub>Ed</sub> in terms of the service class and the load duration class: F<sub>Ed</sub>= F<sub>Rk</sub> X k<sub>mod</sub> / γ<sub>M</sub>.

The characteristic load-bearing capacities for the L series were determined using 8 x 120 VG screws. Higher capacities can be achieved with longer screws (however, the minimum cross-sections of the supports also change)

Please note: These are planning aids. Projects must only be calculated by authorised persons.

# ECS calculation aid

The Eurotec ECS calculation software allows you to create verifiable calculation aids according to ETA-15/0761 and EN 1995 (Eurocode 5) in an extremely short space of time.

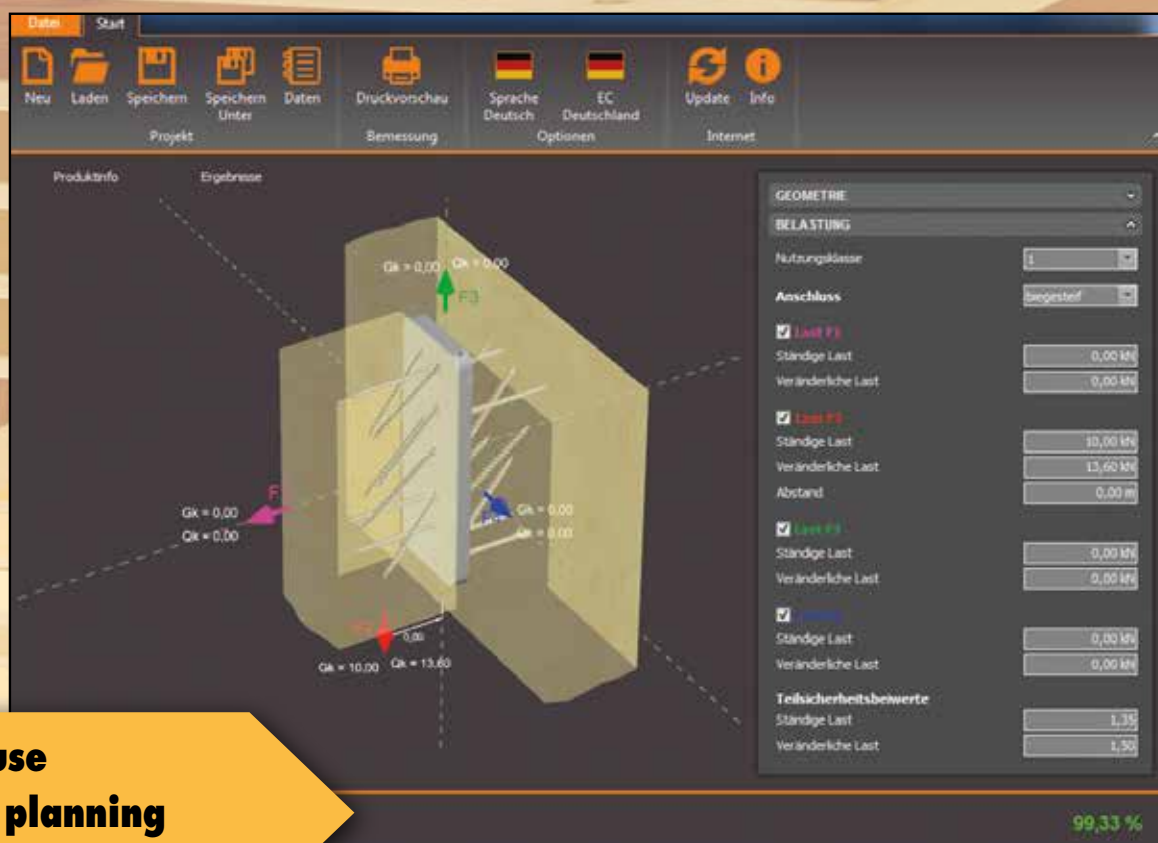

- **Ease to use**
- **Reliable planning**
- **Optimisation**



by phone 02331 6245-444 · by fax 02331 6245-200 · by e-mail [technik@eurotec.team](mailto:technik@eurotec.team)

Please contact our technical department or use the free calculation services in the service section of our website.

Contact

Trader:	_____	Contractor:	_____
Contact Person:	_____	Contact Person:	_____
e-mail:	_____	Phone:	_____
Project:	_____	e-mail:	_____

Project details

Main Beam

Width: \_\_\_\_\_ mm

Height: \_\_\_\_\_ mm

Strength class: \_\_\_\_\_  
(e.g. C24, GL24h etc.)

Secondary Beam

Width: \_\_\_\_\_ mm

Height: \_\_\_\_\_ mm

Strength class: \_\_\_\_\_  
(e.g. C24, GL24h etc.)

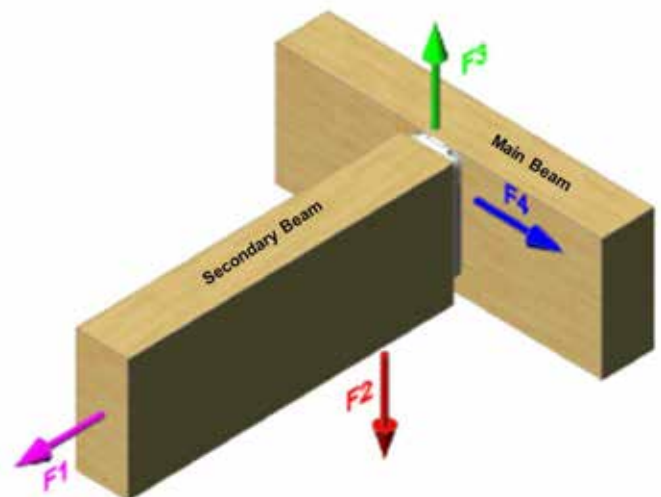

<b>F1</b>	- Ratio of permanent load:	_____	kN
	- Ratio of changing load:	_____	kN
<b>F2</b>	- Ratio of permanent load:	_____	kN
	- Ratio of changing load:	_____	kN
<b>F3</b>	- Ratio of permanent load:	_____	kN
	- Ratio of changing load:	_____	kN
<b>F4</b>	- Ratio of permanent load:	_____	kN
	- Ratio of changing load:	_____	kN

Loads (Characteristic values)

Duration of the load effect

permanent    long    medium    short

Installation

founded

inserted into secondary beam

inserted into main beam

Selection of Magnus

XS 30 x 30    S 50 x 60/80/100    M 70 x 120/140/160/180    L 110 x 220/260/300/340/380/580

# Atlas wood connector

The node connection for beam suspension



## What can it be used for?

- Can be used for almost all areas of timber construction, regardless of the timber's grain direction, i.e. vertically and horizontally!
- Secondary and main beams
- Secondary beam – support
- Bolt construction
- Hall construction
- Façade construction
- Conservatories

## Advantages

- Quick and simple connections
- Consists of two identical parts that can be slid inside each other smoothly without restraint
- Can be statically loaded in four directions with high tested values

## Assembly

- Installation can be both visible (for shadow-groove connections) and invisible (milled in).
- System screws and the suitable DUO bit are included in the delivery.
- See the installation instructions on p. 168



## Atlas wood connector



Art. no.	Name	Included in delivery	PU*
30036	Atlas HF 70	120 Fully threaded screw TX15 - 4,0 x 60 mm, blue galvanised 10 Fixing screws TX15 - 4,2 x 50 mm, blue galvanised Assembly instructions; 1 Stück DUO-Bit TX 15	10
30056	Atlas HF 100	160 Fully threaded screw TX20 - 5,0 x 80 mm, blue galvanised 10 Fixing screws TX20 - 4,8 x 80 mm, blue galvanised Assembly instructions; 1 Stück DUO-Bit TX 20	10
30076	Atlas HF 135	220 Fully threaded screw TX20 - 5,0 x 80 mm, blue galvanised 10 Fixing screws TX20 - 4,8 x 120 mm, blue galvanised Assembly instructions; 1 Stück DUO-Bit TX 20	10
30096	Atlas HF 170	280 Fully threaded screw TX20 - 5,0 x 80 mm, blue galvanised 10 Fixing screws TX20 - 4,8 x 120 mm, blue galvanised Assembly instructions; 1 Stück DUO-Bit TX 20	10
30116	Atlas HF 200	144 Fully threaded screw TX25 - 6,0 x 100 mm, blue galvanised 6 Fixing screws TX25 - 6,3 x 180 mm, blue galvanised Assembly instructions; 1 Stück DUO-Bit TX 25	6

Art. no.	Name	Included in delivery	for
29606	Template set HFSS 70	1 Milling and assembling jig with stopper HFS 70 1 Cutter with thrust ring HFF 70 4 Fully threaded screw TX15 - 4,0 x 60 mm, galvanised 2 Hexagon socket screws M 5 x 16 mm, 1 Allen key 4 mm Assembly instructions	Atlas HF 70
29161	Template set HFSS 100	1 Milling and assembling jig with stopper HFS 100 1 Cutter with thrust ring HFF 100 4 Fully threaded screw TX20 - 5,0 x 40 mm, galvanised 2 Hexagon socket screws M 5 x 16 mm, 1 Allen key 4 mm Assembly instructions	Atlas HF 100 Atlas HF 135 Atlas HF 170
29626	Template set HFSS 200	1 Milling and assembling jig with stopper HFS 200 1 Cutter with thrust ring HFF 200 4 Fully threaded screw TX25 - 6,0 x 60 mm, galvanised 2 Hexagon socket screws M 5 x 16 mm, 1 Allen key 4 mm Assembly instructions	Atlas HF 200

\* 1 connector consists of 2 individual parts

## Our Atlas starter packs

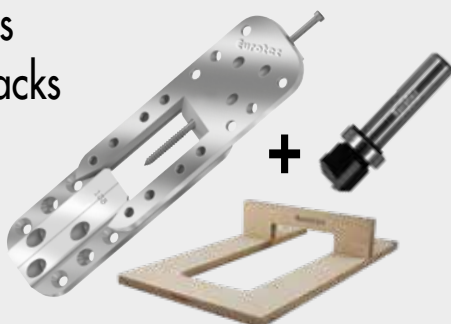

### Set 1

Art.-Nr. 30126

- 40 x Atlas HF 100 (= 20 pairs)  
Screws are included with this product
- 1 x Timber milling & assembly
- 1 x Milling cutter

### Set 2

Art.-Nr. 30136

- 40 x Atlas HF 135 (= 20 pairs)  
Screws are included with this product
- 1 x Timber milling & assembly
- 1 x Milling cutter



## Template

For Atlas wood connector



Art. no.	Suitable for	Material	PU
29658	Atlas HF 70	Wood	1
29657	Atlas HF 100	Wood	1
29660	Atlas HF 135	Wood	1
29661	Atlas HF 170	Wood	1
29659	Atlas HF 200	Wood	1

## Milling cutter

For Atlas wood connector



Art. no.	Suitable for	Shaft diameter [mm]	PU
29676	Atlas HF 70	8,00	1
29686	Atlas HF 100, HF 135, HF 170	8,00	1
29696	Atlas HF 200	8,00	1

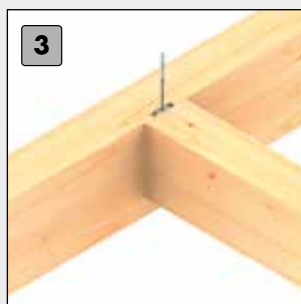
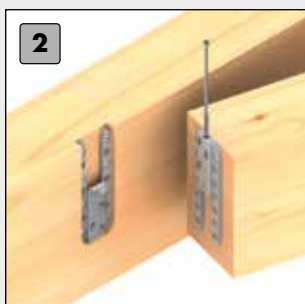
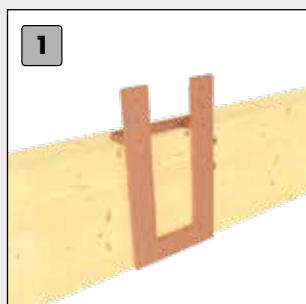

## Assembly

- 1 Simply set the stopper for the template to the required size of the Atlas wood connector, put the template in place, fix it and cut out the pocket with the corresponding groove miller.
- 2 The Atlas is then set into the milled recess and fastened with the supplied system screws. The template is then placed in the same setting on the component that is to be connected and the identical second part of the Atlas wood connector is screwed in place. Pre-assembly is now complete and the component to be connected is suspended in place.
- 3 In conclusion, the fixing screw is inserted into the Atlas. In this way the Atlas wood connector is pulled together, if necessary, and the position security of the hook connector is guaranteed. THAT'S IT!

The installation can therefore be both visible (for broad root with chamfer connections) and invisible (milled recess). The above assembly example shows the invisible installation. With visible installation, there is no need for milling and the template is only used as an assembling jig.

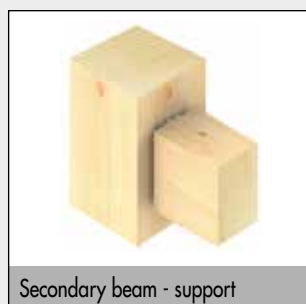

# Technical data

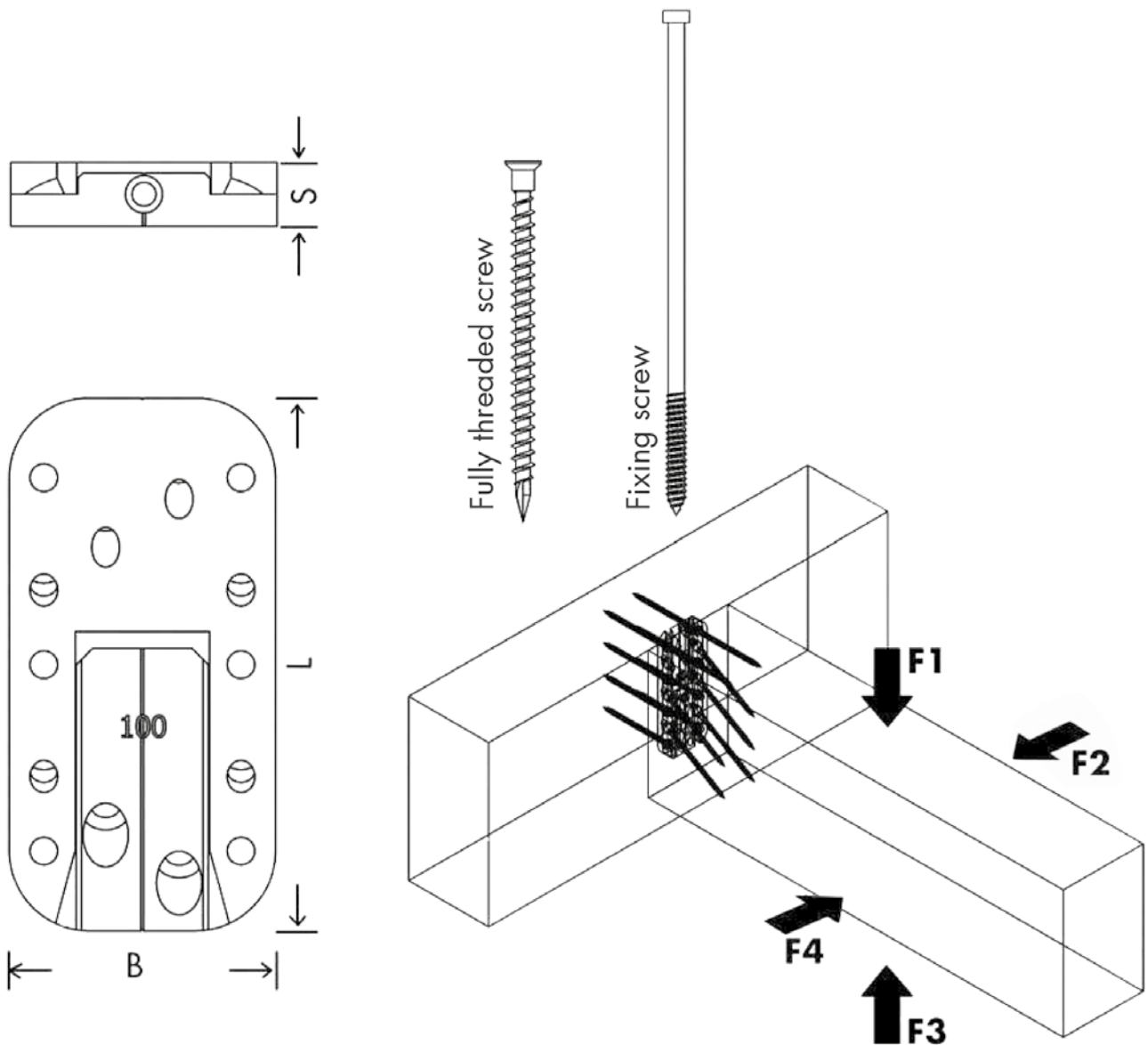

Art. no.	Type	Atlas permitted value			Secondary beam		Load F1	Load F3	Load F2 and F4
		L	W	S	min. width	min. height	Char. value of the load-bearing capacity $R_k^{a)}$	Char. value of the load-bearing capacity $R_k^{a)}$	Char. value of the load-bearing capacity $R_k^{a)}$
		[mm]	[mm]	[mm]	[mm]	[mm]	[kN]	[kN]	[kN]
30036	70	70	30	9	50	80	6,80	2,00	4,40
30056	100	100	50	12	80	115	17,40	8,56	10,60
30076	135	135	50	12	80	150	26,70	8,56	15,00
30096	170	170	50	12	80	185	33,40	8,56	16,00
30116	200	200	70	17	100	200	43,00	19,15	22,70

Calculation according to ETA-12/0068. Wood density  $\rho_k = 350 \text{ kg/m}^3$ . All mechanical values provided should be viewed as subject to the assumptions that have been made and represent example calculations.

All values are calculated minimum values and are subject to typographical and printing errors.

a) The characteristic values of the load-bearing capacity  $R_k$  should not be treated as equivalent to the max. possible load (the max. force).

Characteristic values of the load-bearing capacity  $R_k$  should be reduced to dimensioning values  $R_d$  with regard to the usage class and class of the load duration:  $R_d = R_k \times k_{mod} / \gamma_M$ .

The dimensioning values of the load-bearing capacity  $R_d$  should be contrasted with the dimensioning values of the loads ( $R_d \geq E_k$ ).

Example: Characteristic value for constant load (dead weight)  $G_k = 2,00 \text{ kN}$  and variable load (e. g. snow load)  $Q_k = 3,00 \text{ kN}$ .  $k_{mod} = 0,9$ .  $\gamma_M = 1,3$ .

→ Dimensioning value of the load  $E_k = 2,00 \cdot 1,35 + 3,00 \cdot 1,5 = 7,20 \text{ kN}$ . The load-bearing capacity of the joint is therefore considered to have been demonstrated if  $R_d \geq E_k$ . →  $\min R_d = R_k \cdot \gamma_M / k_{mod}$

D.h., i.e. the characteristic minimum value of the load-bearing capacity is calculated based on:  $\min R_k = R_d \cdot \gamma_M / k_{mod} \rightarrow R_k = 7,20 \text{ kN} \cdot 1,3 / 0,9 = 10,40 \text{ kN}$  → comparison with table values.

Please note: These are planning aids. Projects must only be calculated by authorised persons.

# Support-transom connector



## What can it be used for?

- Designing slim components at least 60 mm wide as a main / secondary beam joint in the façade
- Glass façade
- Conservatories

## Advantages

- Easy installation
- High level of prefabrication
- Visible (surface-mounted) and hidden (flush-mounted) joints
- Short slide-in distance





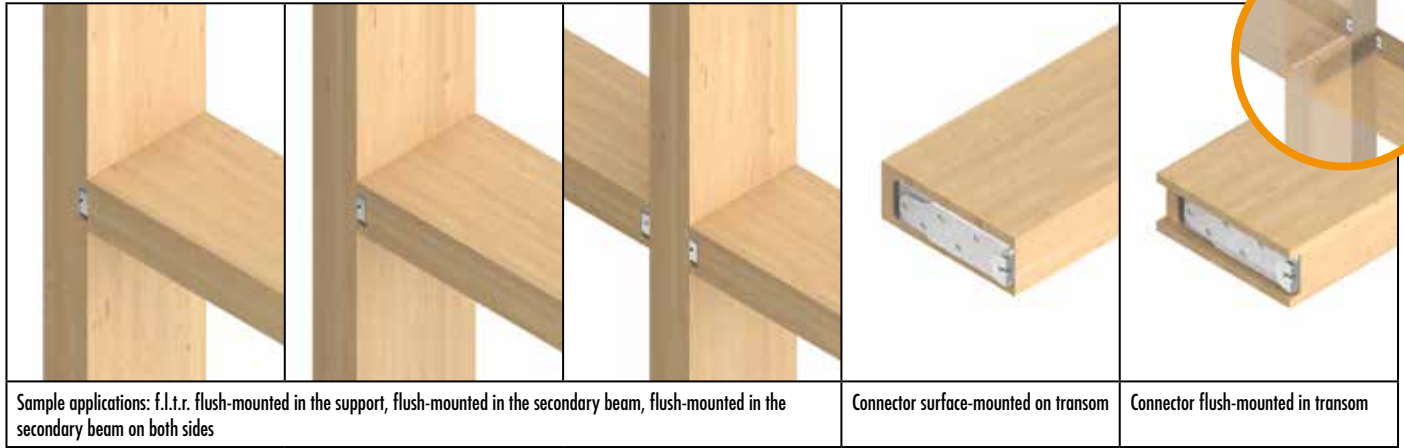

Sample applications: f.l.t.r. flush-mounted in the support, flush-mounted in the secondary beam, flush-mounted in the secondary beam on both sides

Connector surface-mounted on transom

Connector flush-mounted in transom

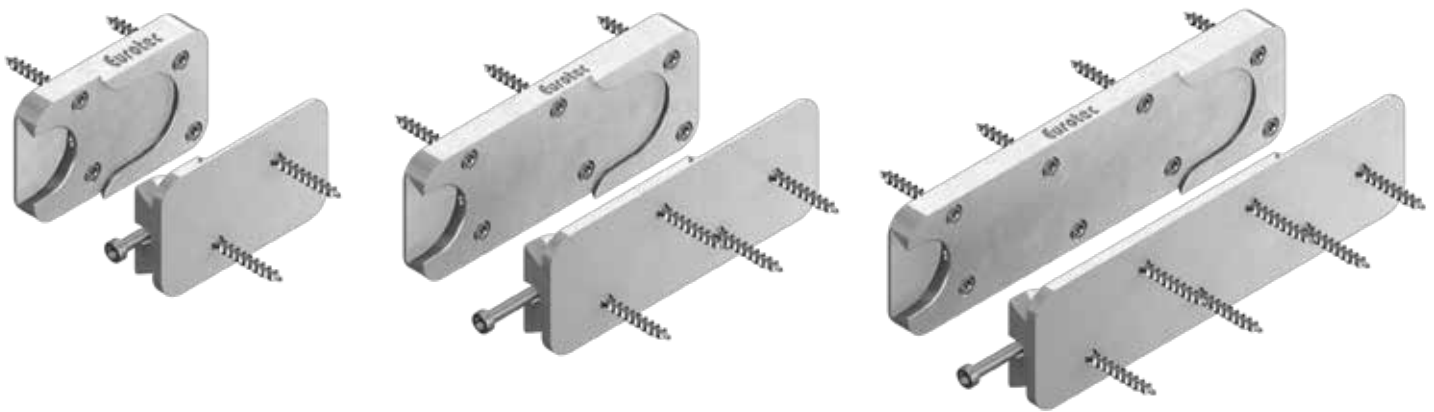

Art. no.	Type	Dimensions W x L x D <sup>a)</sup> [mm]	Fully threaded screw <sup>b)</sup>		Fixing screws <sup>b)</sup>		Min. timber cross-sections			
			Dimensions [mm]	n <sub>per connector</sub>	Dimensions [mm]	n <sub>per connector</sub>	Main beam (support)		Secondary beam (transom)	
							min. W [mm]	min. H (depth) [mm]	min. W [mm]	min. H (depth) [mm]
904744	40 x 65	40 x 65 x 12	4,0 x 60	8	4,2 x 26	1	60	80	60	80
904768	40 x 85	40 x 85 x 16	5,0 x 60	8	4,8 x 60	1	60	100	60	100
904745	40 x 105	40 x 105 x 16	5,0 x 60	10	4,8 x 60	1	60	120	60	120
904769	40 x 125	40 x 125 x 16	5,0 x 60	12	4,8 x 60	1	60	140	60	140
904746	40 x 145	40 x 145 x 16	5,0 x 60	14	4,8 x 60	1	60	160	60	160

a) D= connector assembly thickness

b) Included in delivery

# Lifting Anchor, Lifting Anchor Mini



## What can it be used for?

- For transportation of prefabricated wall modules
- Specifically designed for use with a ball supporting bolt

## Advantages

- Easy to assemble
- Reusable
- Can be used in solid structural timber and cross-laminated timber
- Transporting large loads

## Assembly

- Quick and easy installation
- This product is subject to important conditions!  
Please also watch the video at [www.eurotec.team](http://www.eurotec.team) and follow the instructions for use.

**This product is subject to important conditions!**

**Please also watch the Application video and follow the instructions for use.**

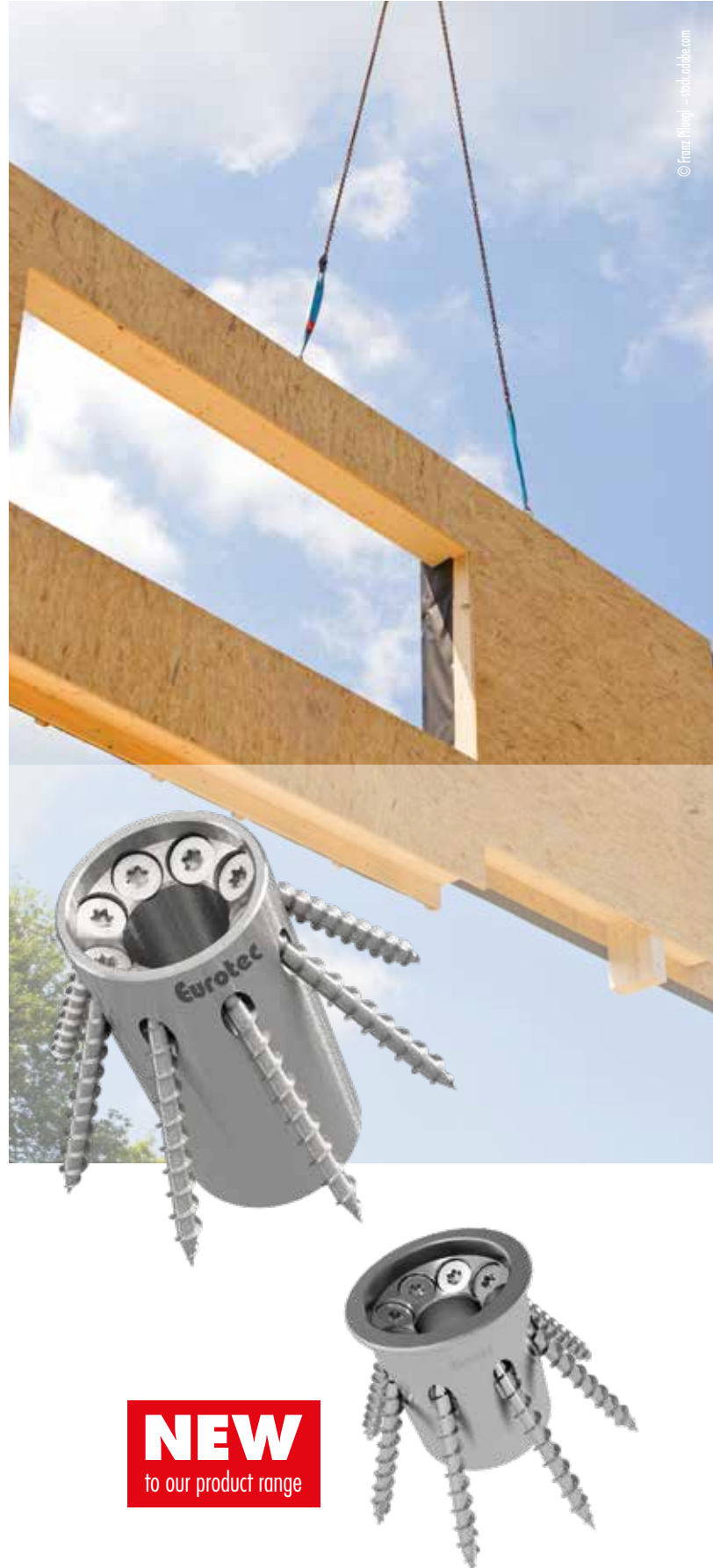

## Lifting Anchor



Lifting Anchor

Ball supporting bolt

### Description

The Lifting Anchor is specifically designed for use with a ball supporting bolt. The lifting anchor can be used to transport prefabricated wall modules. The fact that it is used with screws means the anchor can be used several times. 8 screws are included in delivery.

### Advantages

- Easy to assemble
- Reusable
- Can be used in solid structural timber and cross-laminated timber
- Transporting large loads

### Instructions for use

The product only works in combination with the ball supporting bolt (20 mm in diameter, 50 mm long) provided for this purpose.

The specifications of the product data sheet must be observed! Please consult with our technical department and download the product data sheet from our website, [www.eurotec.team](http://www.eurotec.team).

**Please note**

**This product is subject to important conditions!**

**Please also watch the Application video and follow the instructions for use.**



Art. no.	Designation	Dimensions [mm] <sup>a)</sup>	Material	PU*
944892	Lifting Anchor	60 x 40	SJ235	4

a) Height x Diameter

\* Comes supplied with screws

Art. no.	Designation	Dimensions [mm] <sup>a)</sup>	Material	F1 [kN]	F2 [kN]	F3 [kN]	PU
944893	Ball supporting bolt	50 x 20	SJ235	10	8,5	6,5	1

a) Height x Diameter



Lifting a vertical wall using two assembled Lifting Anchors and ball supporting bolts (H) on the narrow side.



The Lifting Anchor in combination with the ball supporting bolt.

## Horizontal wall or beam: Set upright, then lift

Glue-laminated timber beams			
Connection in the	Connector	Stop bracket	Total weight [kg]
Side area	Lifting Anchor + 8 x VSS 6 x 60	$\beta$	with 2 strands
		30°	488
		45°	581
		60°	626
		75°	647
		$\beta$	with n strands
		90°	n x 327

Glue-laminated timber wall			
Connection in the	Connector	Stop bracket	Total weight [kg]
End grain area	Lifting Anchor + 8 x VSS 6 x 60	$\beta$	with 2 strands
		30°	255
		45°	360
		60°	441
		75°	492
		$\beta$	with n strands
		90°	n x 255

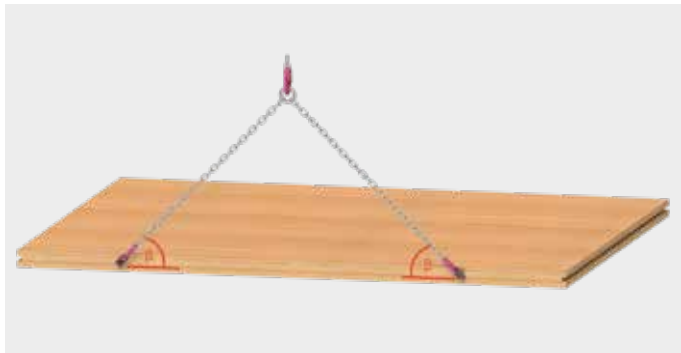

Vertical GLT wall or beam, grain flow: vertical



Vertical GLT wall or beam, grain flow: vertical

### Notes:

The tables illustrate the 'Setting upright and subsequently lifting a horizontal wall or horizontal beam' load case (lifting from a horizontal position leading to vertical suspension). The connectors must be screwed into the components' centre plane flush, plus perpendicular to the surfaces of the narrow sides and side or end grain areas.



## Horizontal wall or beam: Set upright, then lift

CLT wall or beam			
Connection in the	Connector	Stop bracket	Total weight [kg]
End grain area	Lifting Anchor + 8 x VSS 6 x 60	30°	444
		45°	528
		60°	569
		75°	588
		$\beta$	with n strands
		90°	n x 297

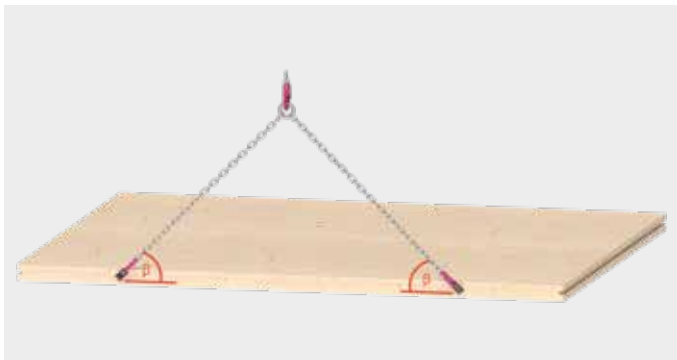

Horizontal CLT wall or beam



Vertical CLT wall or beam

## Vertical wall or beam: Lift

Glue-laminated timber beams			
Connection in the	Connector	Stop bracket	Total weight [kg]
Side area	Lifting Anchor + 8 x VSS 6 x 60	$\beta$	with 2 strands
		30°	659
		45°	929
		60°	929
		75°	929
		$\beta$	with n strands
		90°	n x 464

Glue-laminated timber wall			
Connection in the	Connector	Stop bracket	Total weight [kg]
End grain area	Lifting Anchor + 8 x VSS 6 x 60	$\beta$	with 2 strands
		30°	288
		45°	482
		60°	759
		75°	1170
		$\beta$	with n strands
		90°	n x 743

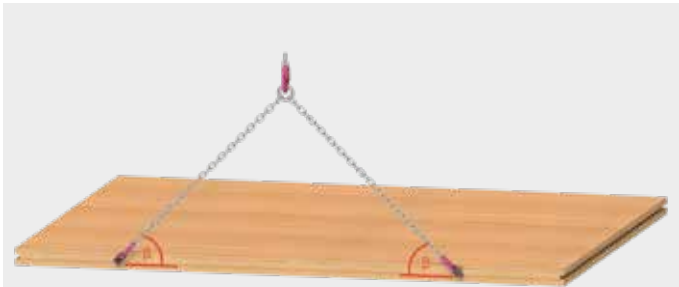

Horizontal GLT wall or beam, grain flow: horizontal



Vertical GLT wall or beam, grain flow: horizontal

### Notes:

The tables illustrate the 'Lifting a vertical wall or beam' load case (lifting from a horizontal position leading to vertical suspension).

The table values are only valid for lifting or assembly states.

## Vertical wall or beam: Lift

CLT wall or beam			
Connection in the	Connector	Stop bracket	Total weight [kg]
		$\beta$	with 2 strands
Narrow surface	Lifting Anchor + 8 x VSS 6 x 60	30°	601
		45°	886
		60°	1135
		75°	1311
		$\beta$	with n strands
		90°	n x 688



Vertical CLT wall or beam

## Lift the horizontal ceiling

### Glue-laminated timber beams

Connection in the	Connector	Stop bracket	Ground plan bracket	Total weight [kg]		
		$\beta$	$\bar{\alpha}$	with 4 strands		
Side area	Lifting Anchor + 8 x VSS 6 x 60	30°	5°	1308		
			15°	1229		
			25°	1114		
			35°	1000		
			45°	905		
			60°	804		
			75°	749		
		45°	5°	1859		
			15°	1838		
			25°	1704		
			35°	1563		
			45°	1439		
			60°	1301		
			75°	1222		
		60°	5°	1858		
			15°	1858		
			25°	1858		
			35°	1858		
			45°	1858		
			60°	1858		
			75°	1830		
		75°	5°	1858		
			15°	1859		
			25°	1859		
			35°	1858		
			45°	1858		
			60°	1858		
			75°	1858		
				$\beta$	$\bar{\alpha}$	with 2 strands
		30°	0°	659		
90°	366					
45°	0°	929				
	90°	598				
60°	0°	929				
	90°	900				
75°	0°	929				
	90°	929				
		$\beta$	$\bar{\alpha}$	with n strands		
90°	0°	n x 464				



CLT ceiling				
Connection in the	Connector	Stop bracket	Ground plan bracket	Total weight [kg]
		$\beta$	$\bar{\theta}$	with 4 strands
Side area	Lifting Anchor + 8 x VSS 6 x 60	30°	5°	1193
			15°	1121
			25°	1015
			35°	911
			45°	824
			60°	732
			75°	682
		45°	5°	1762
			15°	1683
			25°	1559
			35°	1429
			45°	1314
			60°	1187
			75°	1091
		60°	5°	2262
			15°	2205
			25°	2108
			35°	1995
			45°	1887
			60°	1756
			75°	1649
		75°	5°	2620
			15°	2600
			25°	2564
			35°	2518
			45°	2469
			60°	2401
			75°	2339
		$\beta$	$\bar{\theta}$	with 2 strands
		30°	0°	1203
90°	333			
45°	0°	1773		
	90°	545		
60°	0°	2270		
	90°	824		
75°	0°	2623		
	90°	1169		
$\beta$	$\bar{\theta}$	with n strands		
90°	0°	688		

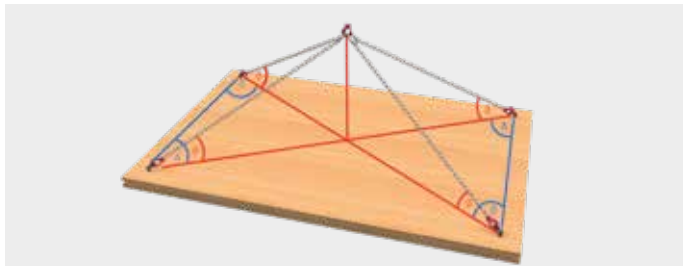

Glue-laminated timber beams

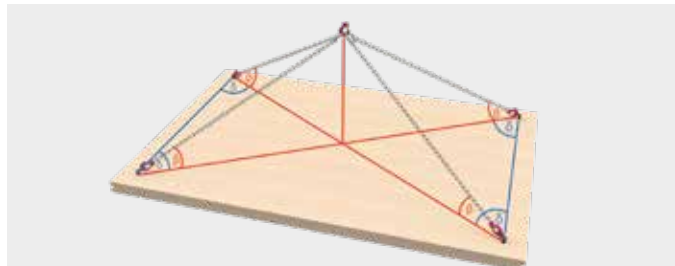

CLT ceiling

**Notes:**

The tables illustrate the 'Lifting horizontal ceiling elements' load case (lifting from a horizontal position leading to vertical suspension).

The connectors must be screwed in flush with the surface, plus perpendicular to the component surface.

## Operating instructions for the ball supporting bolt

**Warning!**

Ball supporting bolts are designed for lifting and holding individual loads (**not people!!!**). In addition, they are **not suitable for continuous load rotation**. Contamination (e.g. grinding sludge, oil and emulsion deposits, dust, etc.) can impair the function of ball supporting bolts.

Damaged ball supporting bolts can put people's lives at risk. Before each use, ball supporting bolts must be inspected for visible defects (e.g. deformations, fractures, cracks, damage, missing balls, corrosion, function of the locking mechanism).

**Damaged ball supporting bolts must be withdrawn from further use.**

**Handling and loading**

Press the button (A) to release the balls. The balls are locked again by releasing the button (A).

**Please note: The button (A) is locked when the spring force has caused it to spring back to its original position. Do not press the button when loaded!**

The load values F1 / F2 / F3 (see page 2) apply to lifting in a steel receptacle and x min. = 1.5 mm

**Maintenance**

Ball supporting bolts must be subjected to a safety inspection by a competent person at least once a year.

**Visual inspection**

Deformations, fractures, cracks, missing / damaged balls, corrosion, screw connection damage on the shackle.

**Functional test**

The balls' locking and unlocking mechanism must close automatically by spring force.

Full shackle mobility is guaranteed.



d <sub>1</sub>	l <sub>1</sub>	d <sub>2</sub>	d <sub>3</sub>	d <sub>4</sub> min.	l <sub>2</sub>	l <sub>3</sub>	l <sub>4</sub>	l <sub>5</sub>	l <sub>6</sub>	l <sub>7</sub>	l <sub>8</sub>	x min.*	x max.*	D H11	F <sub>1</sub> kN*	F <sub>2</sub> kN*	F <sub>3</sub> kN*
20,0	50	24,50	30,0	25,00	19,70	36,5	52,0	32,6	36	56	114,0	1,5	25	20,0	10,0	8,5	6,5

\* with five-fold protection against breakage

**Original EC conformity mark**

The product complies with the regulations set down in the EC Directive 2006/42/EC.



Make: Ball supporting bolt

Type: EH 22350

Applied standards: DIN EN 13155

## Lifting Anchor Mini

**NEW**  
to our product range



Lifting Anchor Mini



Ball supporting bolt

### Description

The Lifting Anchor Mini is specifically designed for use with a ball supporting bolt. Smaller loads such as beams or struts can be easily transported with the lifting anchor. A collar at the top edge prevents slipping through in the drill hole. The fact that it is used with screws means the anchor can be used several times.

### Advantages

- The collar at the top of the Lifting Anchor Mini enables quick and easy assembly
- Reusable
- Can be used in GLT and CLT
- Low installation depth
- A minimum hole depth of just 47 mm

**Please note**

**This product is subject to important conditions!  
Please follow the instructions for use.**

Art. no.	Designation	Dimensions [mm] <sup>a)</sup>	Material	Number of screws*	PU
944901	Lifting Anchor Mini	49 x 45	S235JR	8	4

a) Height x Diameter  
\*Incl. 8 TX25 fully threaded screws, 6.0 x 6

Art. no.	Designation	Dimensions [mm] <sup>a)</sup>	Material	F1 [kN] <sup>b)</sup>	F2 [kN] <sup>b)</sup>	F3 [kN] <sup>b)</sup>	PU
944905	Ball supporting bolt	25 x 16	SJ235	4,8	4,5	4,1	1

a) Height x Diameter  
\*Please refer to the drawing on the following page for a precise description of the individual forces

Both items must be ordered separately from one another.



Lifting a vertical wall using two assembled Lifting Anchors Mini and ball supporting bolts (H) on the narrow side.



The Lifting Anchor Mini in combination with the ball supporting bolt.

## Forces

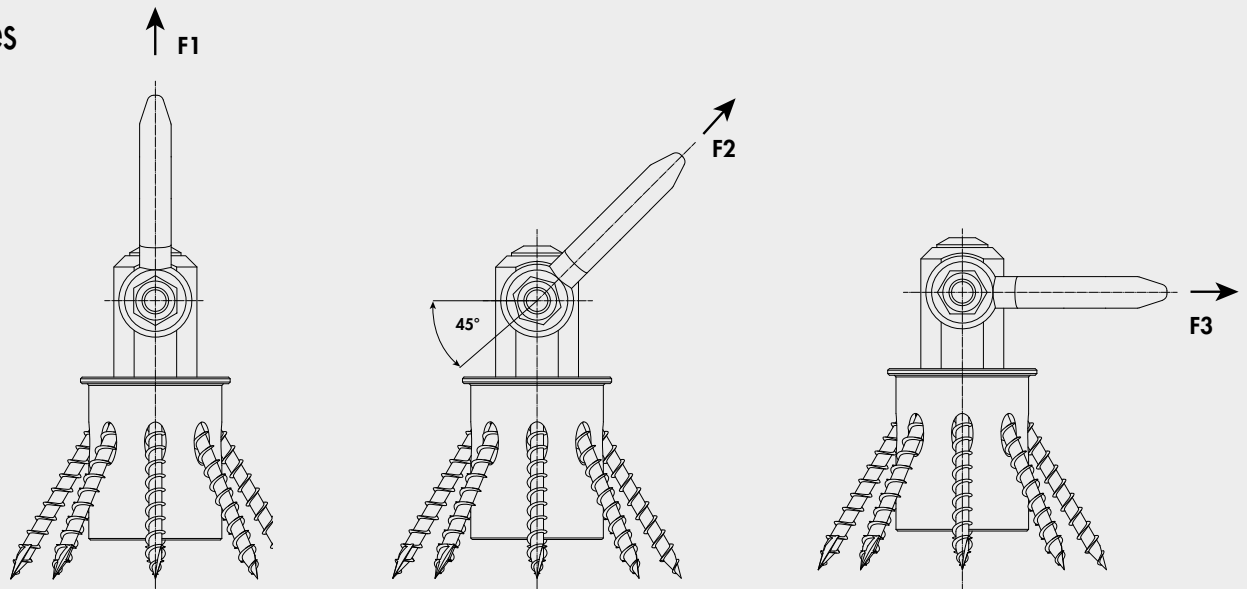

# Operating instructions for the ball supporting bolt

## Warning!

Ball supporting bolts are designed for lifting and holding individual loads (**not people!!!**). In addition, they are not suitable for continuous load rotation. Contamination (e.g. grinding sludge, oil and emulsion deposits, dust, etc.) can impair the function of ball supporting bolts.

Damaged ball supporting bolts can put people's lives at risk. Before each use, ball supporting bolts must be inspected for visible defects (e.g. deformations, fractures, cracks, damage, missing balls, corrosion, function of the locking mechanism).

**Damaged ball supporting bolts must be withdrawn from further use.** The ball carrier bolts have been tested by TÜV.

## Handling and loading

Press the button (A) to release the balls. The balls are locked again by releasing the button (A).

**Please note: The button (A) is locked when the spring force has caused it to spring back to its original position. Do not press the button when loaded!**

The load values F1 / F2 / F3 (see page 2) apply to lifting in a steel receptacle and x min. = 1.5 mm

## Maintenance

Ball supporting bolts must be subjected to a safety inspection by a competent person at least once a year.

## Visual inspection

Deformations, fractures, cracks, missing / damaged balls, corrosion, screw connection damage on the shackle.

## Functional test

The balls' locking and unlocking mechanism must close automatically by spring force. Full shackle mobility is guaranteed

## Use

The Lifting Anchor Mini must only be used by competent staff.



d <sub>1</sub>	l <sub>1</sub>	d <sub>2</sub>	d <sub>3</sub>	d <sub>4 min.</sub>	l <sub>2</sub>	l <sub>3</sub>	l <sub>4</sub>	l <sub>5</sub>	l <sub>6</sub>	l <sub>7</sub>	l <sub>8</sub>	x min.*	x max.*	D H11	F <sub>1</sub> kN*	F <sub>2</sub> kN*	F <sub>3</sub> kN*
20,0	50	24,50	30,0	25,00	19,70	36,5	52,0	32,6	36	56	114,0	1,5	25	20,0	10,0	8,5	6,5

\* with five-fold protection against breakage



## Original EC conformity mark

The product complies with the regulations set down in the EC Directive 2006/42/EC.

Manufacture\*: Erwin Halder KG  
Address\*: Erwin-Halder-Straße 5-9  
88480 Achstetten-Bronnen  
Deutschland

Make: Ball supporting bolt  
Type: EH 22350  
Applied standards: DIN EN 13155

*S. Halder*

Achstetten-Bronnen, 22. Dezember 2016

Stefan Halder, Geschäftsleitung

\*Responsible for documentation



## Horizontal wall or beam: Set upright, then lift

Glue-laminated timber beams			
Connection in the	Connector	Stop bracket	Total weight [kg]
Side area	Lifting Anchor Mini Ø 40 mm + 8 x VSS 6 x 60	β	with 2 strands
		30°	273
		45°	324
		60°	350
		75°	361
		β	with n strands
		90°	n x 183

Glue-laminated timber wall			
Connection in the	Connector	Stop bracket	Total weight [kg]
End grain area	Lifting Anchor Mini Ø 40 mm + 8 x VSS 6 x 60	β	with 2 strands
		30°	142
		45°	201
		60°	246
		75°	275
		β	with n strands
		90°	n x 142



Horizontal GLT wall or beam, grain flow: vertical



Vertical GLT wall or beam, grain flow: vertical

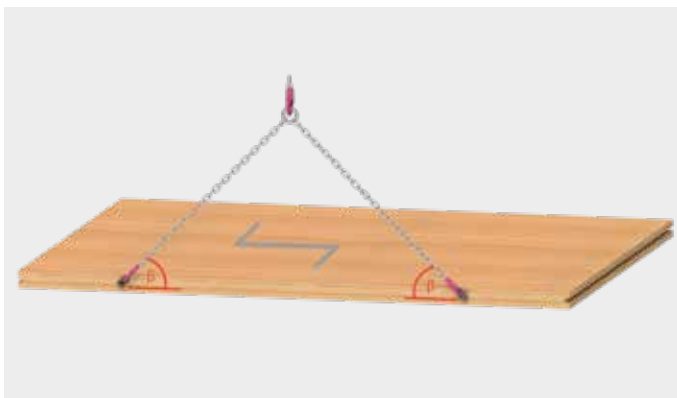

Horizontal GLT wall or beam, grain flow: horizontal



Vertical GLT wall or beam, grain flow: horizontal

## Horizontal wall or beam: Set upright, then lift

CLT wall or beam			
Connection in the	Connector	Stop bracket	Total weight [kg]
End grain area	Lifting Anchor Mini $\varnothing$ 40 mm + 8 x VSS 6 x 60	30°	248
		45°	295
		60°	318
		75°	328
		$\beta$	with n strands
		90°	n x 166

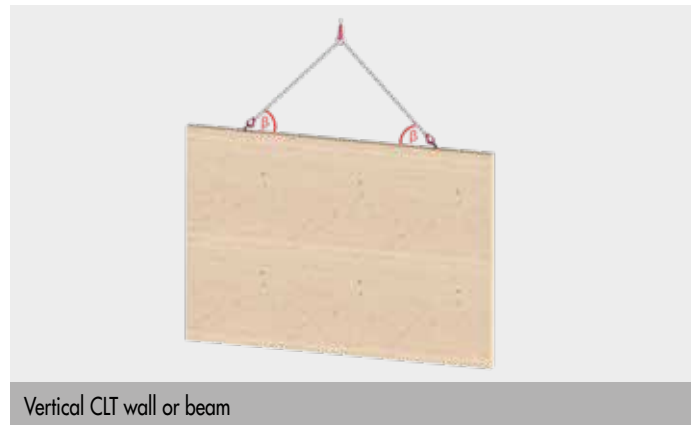
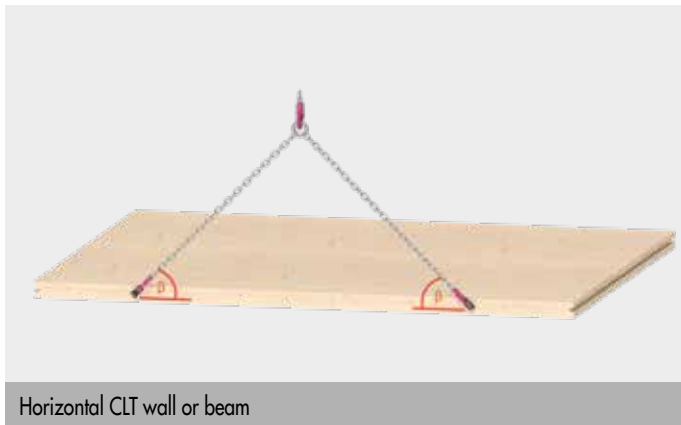

## Notes:

- The tables are based on the expert evaluation report entitled 'Load-Carrying Capacity of Connections with E.u.r.o. Tec HebeFix Mini Lifting Anchors' by H.J. Blafß, 01/12/2020.
- The tables illustrate the 'Horizontal wall or beam: Set upright, then lift' load case.
- The table values are only valid for lifting or assembly states.
- The minimum cross-section thickness for walls and beams is 100 mm.
- The minimum distances between the edges of the connectors parallel to the component plane is 200 mm.
- The connectors must be screwed into the components' centre plane flush, plus perpendicular to the surfaces of the narrow sides and side or end grain areas.
- The values in the table apply to characteristic raw densities of min. 350 kg/m<sup>3</sup> for CLT and 385 kg/m<sup>3</sup> for GLT.
- According to the above-mentioned expert report, a vibration coefficient of min  $\varphi = 2,0$  must be used.
- The values stated in the table take a vibration coefficient of  $\varphi = 2,0$  into account. For deviating vibration coefficients, the table values must be multiplied by the factor  $2,0/\varphi$ .

## Vertical wall or beam: Lift

Glue-laminated timber beams			
Connection in the	Connector	Stop bracket	Total weight [kg]
Side area	Lifting Anchor Mini Ø 40 mm + 8 x VSS 6 x 60	$\beta$	with 2 strands
		30°	396
		45°	642
		60°	928
		75°	929
		$\beta$	with n strands
		90°	n x 464

Glue-laminated timber wall			
Connection in the	Connector	Stop bracket	Total weight [kg]
End grain area	Lifting Anchor Mini Ø 40 mm + 8 x VSS 6 x 60	$\beta$	with 2 strands
		30°	163
		45°	279
		60°	468
		75°	864
		$\beta$	with n strands
		90°	n x 743

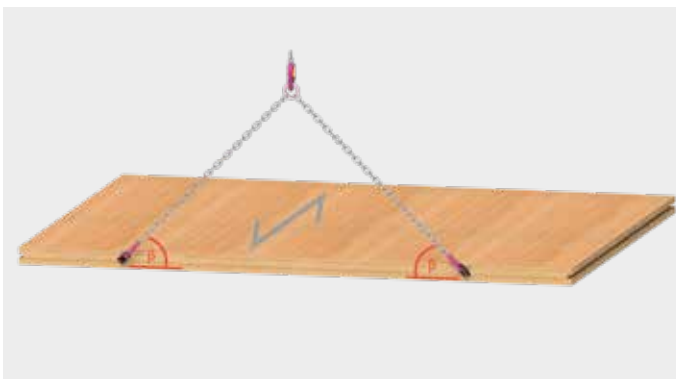

Horizontal GLT wall or beam, grain flow: vertical



Vertical GLT wall or beam, grain flow: vertical

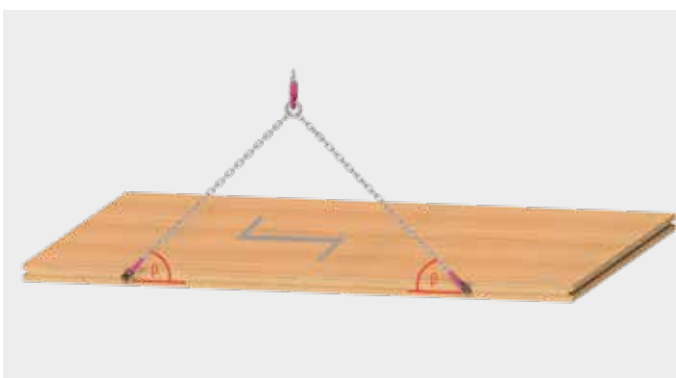

Horizontal GLT wall or beam, grain flow: horizontal



Vertical GLT wall or beam, grain flow: horizontal

## Vertical wall or beam: Lift

CLT wall or beam			
Connection in the	Connector	Stop bracket	Total weight [kg]
Narrow surface	Lifting Anchor Mini $\varnothing$ 40 mm + 8 x VSS 6 x 60	30°	360
		45°	585
		60°	869
		75°	1196
		$\beta$	with n strands
		90°	n x 688

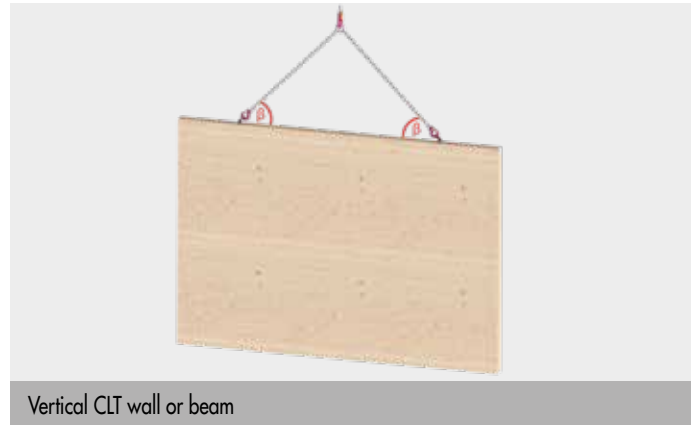
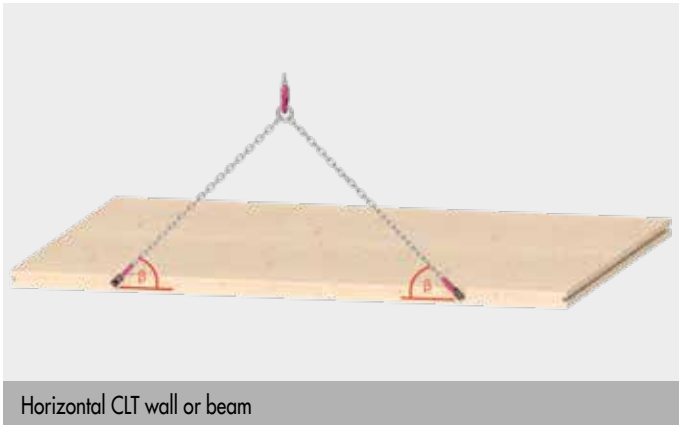

## Notes:

- The tables are based on the expert evaluation report entitled 'Load-Carrying Capacity of Connections with E.u.r.o. Tec HebeFix Mini Lifting Anchors' by H.J. Blafß, 01/12/2020.
- The tables illustrate the 'Horizontal wall or beam: Set upright, then lift' load case.
- The table values are only valid for lifting or assembly states.
- The minimum cross-section thickness for walls and beams is 100 mm.
- The minimum distances between the edges of the connectors parallel to the component plane is 200 mm.
- The connectors must be screwed into the components' centre plane flush, plus perpendicular to the surfaces of the narrow sides and side or end grain areas.
- The values in the table apply to characteristic raw densities of min. 350 kg/m<sup>3</sup> for CLT and 385 kg/m<sup>3</sup> for GLT.
- According to the above-mentioned expert report, a vibration coefficient of min  $\varphi = 2,0$  must be used.
- The values stated in the table take a vibration coefficient of  $\varphi = 2,0$  into account. For deviating vibration coefficients, the table values must be multiplied by the factor  $2,0/\varphi$ .



# Lift the horizontal ceiling

Glue-laminated timber beams						
Connection in the	Connector	Stop bracket $\beta$	Ground plan bracket $\delta$	Total weight [kg] with 4 strands		
Side area	Lifting Anchor Mini $\varnothing$ 40 mm + 8 x VSS 6 x 60	30°	5°	784		
			15°	731		
			25°	654		
			35°	581		
			45°	522		
			60°	461		
		45°	75°	427		
			5°	1273		
			15°	1196		
			25°	1082		
			35°	970		
			45°	877		
		60°	60°	780		
			75°	726		
			5°	1858		
			15°	1800		
			25°	1666		
			35°	1526		
		75°	45°	1403		
			60°	1267		
			75°	1189		
			5°	1858		
			15°	1858		
			25°	1859		
		$\beta$	$\delta$	with 2 strands		
				30°	0°	396
					90°	208
				45°	0°	642
		45°	90°		354	
				60°	0°	928
60°	90°		582			
		75°	0°	929		
75°	90°		929			
		$\beta$	$\delta$	with n strands		
90°	0°		n x 464			

CLT ceiling						
Connection in the	Connector	Stop bracket	Ground plan bracket	Total weight [kg]		
		$\beta$	$\delta$	with 4 strands		
Side area	Lifting Ancho Mini $\varnothing$ 40 mm + 8 x VSS 6 x 60	30°	5°	714		
			15°	665		
			25°	595		
			35°	529		
			45°	475		
			60°	419		
			75°	389		
		45°	5°	1161		
			15°	1091		
			25°	986		
			35°	884		
			45°	799		
			60°	710		
			75°	645		
		60°	5°	1727		
			15°	1648		
			25°	1524		
			35°	1394		
			45°	1281		
			60°	1155		
			75°	1061		
		75°	5°	2385		
			15°	2339		
			25°	2257		
			35°	2160		
			45°	2063		
			60°	1943		
			75°	1841		
				$\beta$	$\delta$	with 2 strands
		30°	0°	721		
90°	189					
45°	0°	1171				
	90°	322				
60°	0°	1738				
	90°	530				
75°	0°	2392				
	90°	920				
		$\beta$	$\delta$	with n strands		
90°	0°	n x 688				

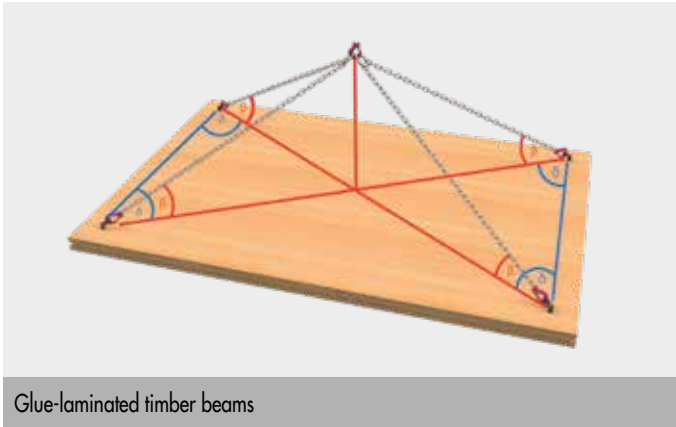

Glue-laminated timber beams

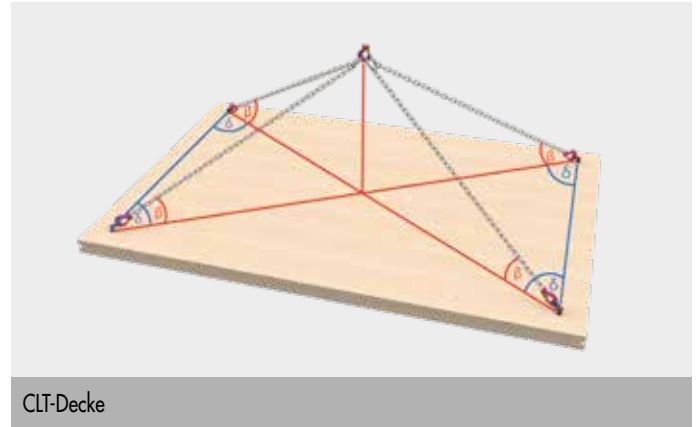

CLT-Decke

## Notes:

- The tables are based on the expert evaluation report entitled 'Load-Carrying Capacity of Connections with E.u.r.o. Tec HebeFix Mini Lifting Anchors' by H.J. Blaß, 01/12/2020.
- The tables illustrate the 'Horizontal wall or beam: Set upright, then lift' load case.
- The table values are only valid for lifting or assembly states.
- The minimum cross-section thickness for walls and beams is 100 mm.
- The minimum distances between the edges of the connectors parallel to the component plane is 200 mm.
- The connectors must be screwed into the components' centre plane flush, plus perpendicular to the surfaces of the narrow sides and side or end grain areas.
- The values in the table apply to characteristic raw densities of min. 350 kg/m<sup>3</sup> for CLT and 385 kg/m<sup>3</sup> for GLT.
- According to the above-mentioned expert report, a vibration coefficient of min  $\varphi = 2,0$  must be used.
- The values stated in the table take a vibration coefficient of  $\varphi = 2,0$  into account. For deviating vibration coefficients, the table values must be multiplied by the factor  $2,0/\varphi$ .

# Round slings

For lifting fragile loads

**NEW**  
to our product range

## Round slings

Bearing capacity 1000 kg



Art. no.	Dimensions	Scope [m]	Load-bearing capacity [kg]	PU
324040	1 m x 5 mm	2	1000	1
324070	1,5 m x 50 mm	3	1000	1

## Round slings

Bearing capacity 2000 kg



Art. no.	Dimensions	Scope [m]	Load-bearing capacity [kg]	PU
324060	1 m x 55 mm	2	2000	1
324080	1,5 m x 55 mm	3	2000	1
324050	2 m x 55 mm	4	2000	1

## Round slings

Bearing capacity 3000 kg



Art. no.	Dimensions	Scope [m]	Load-bearing capacity [kg]	PU
324100	2 m x 65 mm	4	3000	1





# IdeeFix

Hidden wood connector



## What can it be used for?

- As a hidden timber connection
- For wood/wood connections
- Hidden connector for making joints between the column and beam or main and secondary beam and the steel plate and beam

## Advantages

- High load absorption for tensile and transverse loads
- Adjustable tension/detachable
- Universal application
- Low wood-weakening effect
- For single- or multiple-row serial connections

## Assembly

- Quick and easy installation
- Comes supplied with system screws
- See graphic on page 192

### IdeeFix 30



Art. no.	Diameter/Height [mm]	PU
945390	30	25
Incl. fully threaded screws 5,0 x 40 mm		

### IdeeFix 40



Art. no.	Diameter/Height [mm]	PU
944890	40	25
Incl. fully threaded screws 6,0 x 60 mm		

### IdeeFix 50



Art. no.	Diameter/Height [mm]	PU
944896	50	25
Incl. fully threaded screws 8,0 x 90 mm		

**1** Drill



**2** Insert and install supplied screws



**3** Fix construction in place with construction screws – and THAT'S IT!

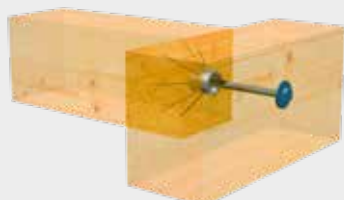



# IdeeFix 30/40/50

Technical information

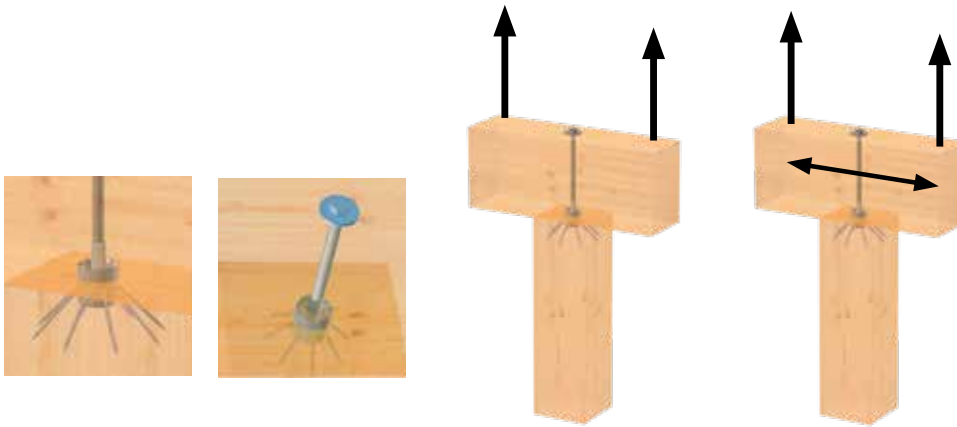

IdeeFix			Timber Dimensions		Tension connection with anti-twist element		Mortise joint with anti-twist element		Tensile load with threaded bolt		
Dimensions [mm]			Min. cross section post		Drilling depth for post	Drilling depth for cross-piece	Drilling depth for post	Drilling depth for cross-piece	Perm. Values	Char. Values	Screw pattern
$d_c$	$a_g$	$v_c$	[mm]	[mm]	[mm]	[mm]	[mm]	[mm]	$N_{ze}$ [kN]	$R_{1,3,k}$ [kN]	pc.
30	M12	3	80	80	27	-	20	7	7,62	17,33	
40	M16	5	120	120	35	-	25	10	12,65	28,79	
50	M20	5	160	160	45	-	30	15	20,81	47,35	
30	M12	3	60	80	27	-	20	7	5,71	13,00	
40	M16	5	80	120	35	-	25	10	9,49	21,59	
50	M20	5	120	160	45	-	30	15	15,61	35,51	
30	M12	3	40	80	27	-	20	7	3,81	8,67	
40	M16	5	60	120	35	-	25	10	6,33	14,39	
50	M20	5	80	160	45	-	30	15	10,41	23,67	
30	M12	3	60	60	27	-	20	7	3,81	8,67	
40	M16	5	80	80	35	-	25	10	6,33	14,39	
50	M20	5	120	120	45	-	30	15	10,41	23,67	

$d_c$  is the diameter and the total height of the connector

$a_g$  is the metric connection thread of the connector

$v_c$  is the height of the integrated anti-twist system

Fully threaded screw, GoFix® FX IF 30 5,0 x 40 mm - IF 40 6,0 x 60 mm - IF 50 8,0 x 90 mm

The connection is drawn together using a threaded rod or construction screw with a DIN 440 R washer

Tension connection as a mortise joint with simultaneous absorption of transverse forces

$R_k$  characteristic value calculated according to DIN 1052:2004-08 Timber  $p_k$  380 kg/m<sup>3</sup> Nze. recommended permissible load  $R_k \times 0,8 k_{mod} : 1,3 \text{ ym} : 1,4$ . Factor 1,4 average load safety factor

Please note: The stated values are planning aids. Projects must only be calculated by authorised persons.

## Main/Secondary beam

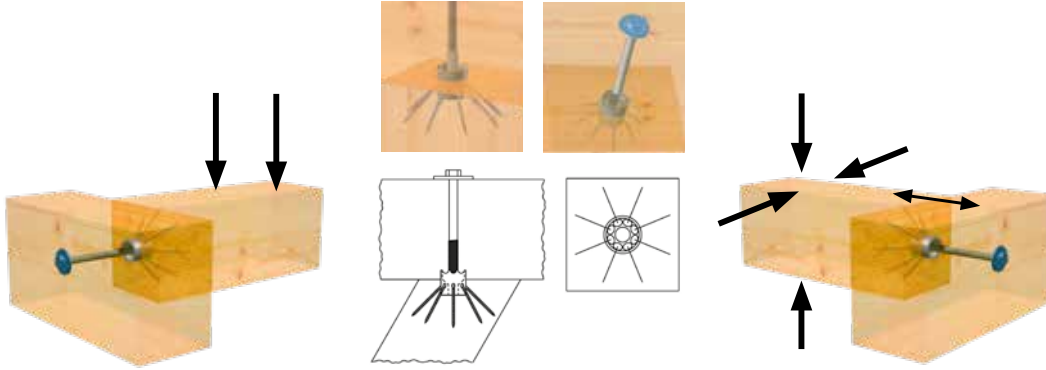

IdeeFix			Timber Dimensions		Timber Dimensions		Main–secondary beam with anti-twist element		Load-bearing capacity with threaded bolt		
Dimensions [mm]			Min. cross section of secondary beam		Min. cross section of main beam		Drilling depth for SB	Drilling depth for MB	Perm. Values	Char. Values	Screw pattern
$d_c$	$a_g$	$v_c$	$w$ [mm]	$h$ [mm]	$w$ [mm]	$h$ [mm]	[mm]	[mm]	$V_{z,e}$ [kN]	$R_{23,k}$ [kN]	pc.
30	M12	3	80	80	80	80	20	7	4,32	8,94	
40	M16	5	120	120	120	120	25	10	6,98	14,66	
50	M20	5	160	160	160	160	30	15	10,88	21,09	
30	M12	3	60	80	60	80	20	7	3,50	7,97	
40	M16	5	80	120	80	120	25	10	5,63	12,80	
50	M20	5	120	160	120	160	30	15	8,65	19,68	
30	M12	3	40	80	40	80	20	7	3,50	7,97	
40	M16	5	60	120	60	120	25	10	5,63	12,80	
50	M20	5	80	160	80	160	30	15	8,65	19,68	
30	M12	3	60	60	60	60	20	7	3,50	7,97	
40	M16	5	80	80	80	80	25	10	5,63	12,80	
50	M20	5	120	120	120	120	30	15	8,65	19,68	

$d_c$  is the diameter and the total height of the connector

$a_g$  is the metric connection thread of the connector

$v_c$  is the height of the integrated anti-twist system

System – Fully threaded screw, GoFix® FK IF 30 5,0 x 40 mm - IF 40 6,0 x 60 mm - IF 50 8,0 x 90 mm

The connection is drawn together using a threaded rod or construction screw with a DIN 440 R washer

MB–SB connection as a mortise joint with simultaneous absorption of tensile forces

$R_k$  characteristic value calculated according to DIN 1052:2004-08 Timber  $p_k$  380 kg/m<sup>2</sup> Nze. recommended permissible load  $R_k \times 0,8 k_{mod}$ : 1,3 ym : 1,4. Factor 1,4 average load safety factor

Please note: The stated values are planning aids. Projects must only be calculated by authorised persons.



## Main/Secondary beam, double-sided connection, with fixing screw

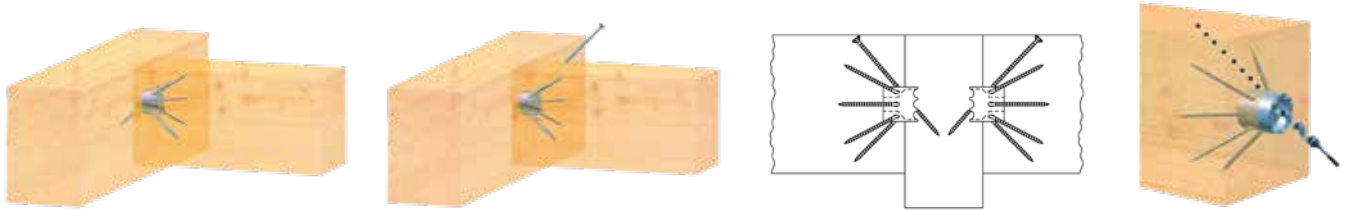

IdeeFix			Timber Dimensions		Timber Dimensions		Main–secondary beam with anti-twist element		Load-bearing capacity with threaded bolt		
Dimensions [mm]			Min. cross section of secondary beam		Min. cross section of main beam		Drilling depth for SB	Drilling depth for MB	Perm. Values	Char. Values	Screw pattern
$d_c$	$a_g$	$v_c$	w [mm]	h [mm]	w [mm]	h [mm]	[mm]	[mm]	$V_{zB}$ [kN]	$R_{233,k}$ [kN]	pc.
30	M12	3	80	80	80	80	20	10	2,34	5,32	
40	M16	5	120	120	120	120	25	15	3,60	8,19	
50	M20	5	160	160	160	160	30	20	5,03	11,44	
30	M12	3	60	80	60	80	20	10	2,34	5,32	
40	M16	5	80	120	80	120	25	15	3,60	8,19	
50	M20	5	120	160	120	160	30	20	5,03	11,44	
30	M12	3	40	80	40	80	20	10	2,34	5,32	
40	M16	5	60	120	60	120	25	15	3,60	8,19	
50	M20	5	80	160	80	160	30	20	5,03	11,44	
30	M12	3	60	60	60	60	20	10	2,34	5,32	
40	M16	5	80	80	80	80	25	15	3,60	8,19	
50	M20	5	120	120	120	120	30	20	5,03	11,44	

$d_c$  is the diameter and the total height of the connector

$a_g$  is the metric connection thread of the connector

$v_c$  is the height of the integrated anti-twist system

System – Fully threaded screw, GoFix® FK IF 30 5,0 x 40 mm - IF 40 6,0 x 60 mm - IF 50 8,0 x 90 mm

Position retention using GoFix® SK IF 30 5,0 x 100 mm, IF 40 6,0 x 140 mm, IF 50 8,0 x 160 mm

MB–SB connection as mortise joint for double-sided connection of secondary beam

$R_k$  characteristic value calculated according to DIN 1052:2004-08 Timber  $p_k$  380 kg/m<sup>3</sup> Nze. recommended permissible load  $R_k \times 0,8 k_{mod}$ : 1,3 ym : 1,4. Favtor 1,4 average load safety factor

Please note: The stated values are planning aids. Projects must only be calculated by authorised persons.

## Main/Secondary beam multiple connection, single-row

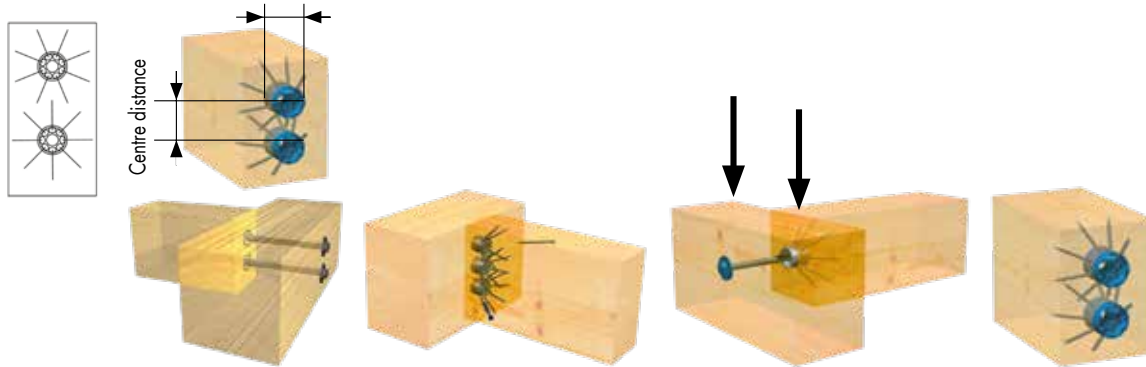

IdeeFix			Timber Dimensions		Edge and centre distance		Main–secondary beam Multiple connection		Load-bearing capacity Single-row		
Dimensions [mm]			Min. cross section of secondary beam		Edge distance	Centre distance	Drilling depth for SB	Drilling depth for MB	Perm. Values	Char. Values	Number of Connectors
d <sub>c</sub>	a <sub>g</sub>	v <sub>c</sub>	w [mm]	h [mm]	[mm]	[mm]	[mm]	[mm]	V <sub>z6</sub> [kN]	R <sub>23,k</sub> [kN]	pc.
30	M12	3	80	80	50	50	20	7	4,32	8,94	1
40	M16	5	120	120	60	60	25	10	6,98	14,66	1
50	M20	5	160	160	80	80	30	15	10,88	21,09	1
30	M12	3	80	150	50	50	20	10	8,64	17,88	2
40	M16	5	120	180	60	60	25	15	13,96	29,32	2
50	M20	5	160	240	80	80	30	20	21,76	42,18	2
30	M12	3	80	200	50	50	20	10	12,96	26,82	3
40	M16	5	120	240	60	60	25	15	20,94	43,98	3
50	M20	5	160	320	80	80	30	20	32,64	63,27	3
30	M12	3	80	250	50	50	20	10	17,28	35,76	4
40	M16	5	120	300	60	60	25	15	27,92	58,64	4
50	M20	5	160	400	80	80	30	20	43,52	84,36	4
30	M12	3	80	300	50	50	20	10	21,60	44,70	5
40	M16	5	120	360	60	60	25	15	34,90	73,30	5
50	M20	5	160	480	80	80	30	20	54,40	105,45	5
30	M12	3	80	350	50	50	20	10	25,92	53,64	6
40	M16	5	120	420	60	60	25	15	41,88	87,96	6
50	M20	5	160	560	80	80	30	20	65,28	126,54	6
30	M12	3	80	400	50	50	20	10	30,24	62,58	7
40	M16	5	120	480	60	60	25	15	48,86	102,62	7
50	M20	5	160	640	80	80	30	20	76,16	117,63	7
30	M12	3	80	450	50	50	20	10	34,56	71,52	8
40	M16	5	120	540	60	60	25	15	55,84	117,28	8
50	M20	5	160	720	80	80	30	20	87,04	168,72	8

d<sub>c</sub> is the diameter and the total height of the connector

a<sub>g</sub> is the metric connection thread of the connector

v<sub>c</sub> is the height of the integrated anti-twist system – Fully threaded screw, GoFix® FK

IF 30 5,0 x 40 mm - IF 40 6,0 x 60 mm - IF 50 8,0 x 90 mm

The connection is drawn together using a threaded rod or constructionscrew with a DIN 440 R washer



MB–SB connection as a mortise joint with simultaneous absorption of tensile forces

R<sub>k</sub> characteristic value calculated according to DIN 1052:2004-08 Timber ρ<sub>k</sub> 380 kg/m<sup>3</sup> Nze. recommended permissible load R<sub>k</sub> x 0,8 k<sub>mod</sub> : 1,3 ym : 1,4. Favor 1,4 average load safety factor

Please note: The stated values are planning aids. Projects must only be calculated by authorised persons.

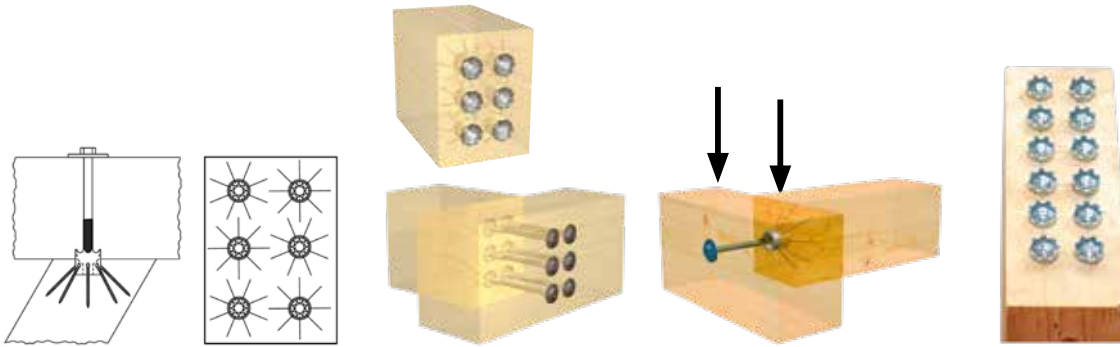
## Main/Secondary beam multiple connection, double-row



IdeeFix			Timber Dimensions		Edge and centre distance		Main–secondary beam Multiple connection		Load-bearing capacity Single-row		 
Dimensions [mm]			Min. cross section of secondary beam		Edge distance	Centre distance	Drilling depth for SB	Drilling depth for MB	Perm. Values	Char. Values	Number of connectors
$d_c$	$a_g$	$v_c$	$w$ [mm]	$h$ [mm]	[mm]	[mm]	[mm]	[mm]	$V_{2e}$ [kN]	$R_{23,k}$ [kN]	pc.
30	M12	3	150	80	50	50	20	10	8,64	17,88	2
40	M16	5	180	120	60	60	25	15	13,96	29,32	2
50	M20	5	240	160	80	80	30	20	21,76	42,18	2
30	M12	3	150	150	50	50	20	10	17,28	35,76	4
40	M16	5	180	180	60	60	25	15	27,92	58,64	4
50	M20	5	240	240	80	80	30	20	43,52	84,36	4
30	M12	3	150	200	50	50	20	10	25,92	53,64	6
40	M16	5	180	240	60	60	25	15	41,88	87,96	6
50	M20	5	240	320	80	80	30	20	65,28	126,54	6
30	M12	3	150	250	50	50	20	10	34,56	71,52	8
40	M16	5	180	300	60	60	25	15	55,84	117,28	8
50	M20	5	240	400	80	80	30	20	87,04	168,72	8
30	M12	3	150	300	50	50	20	10	43,20	89,40	10
40	M16	5	180	360	60	60	25	15	69,80	146,60	10
50	M20	5	240	480	80	80	30	20	108,80	210,90	10
30	M12	3	150	350	50	50	20	10	51,84	107,28	12
40	M16	5	180	420	60	60	25	15	83,76	175,92	12
50	M20	5	240	560	80	80	30	20	130,56	253,08	12
30	M12	3	150	400	50	50	20	10	60,48	125,16	14
40	M16	5	180	480	60	60	25	15	97,72	205,24	14
50	M20	5	240	640	80	80	30	20	152,32	295,26	14
30	M12	3	150	450	50	50	20	10	69,12	143,04	16
40	M16	5	180	540	60	60	25	15	111,68	234,56	16
50	M20	5	240	720	80	80	30	20	174,08	337,44	16

$d_c$  is the diameter and the total height of the connector

$a_g$  is the metric connection thread of the connector

$v_c$  is the height of the integrated anti-twist system

Fully threaded screw, GoFix® FK IF 30 5,0 x 40 mm - IF 40 6,0 x 60 mm - IF 50 8,0 x 90 mm

The connection is drawn together using a threaded rod or constructionscrew with a DIN 440 R washer

MB–SB connection as a mortise joint with simultaneous absorption of tensile forces

$R_k$  characteristic value calculated according to DIN 1052:2004-08 Timber  $\rho_k$  380 kg/m<sup>3</sup> Nze. recommended permissible load  $R_k \times 0,8 k_{mod}$  : 1,3 ym : 1,4. Factor 1,4 average load safety factor

Please note: The stated values are planning aids. Projects must only be calculated by authorised persons.

# PediX post feet

Quick to assemble, with an especially high load-bearing capacity



## What can it be used for?

- For anchoring wooden supports of wooden structures onto concrete foundations
- Carports, canopies, patio roofs
- Can be used in the usage classes 1, 2 and 3 in accordance with DIN EN 1995-1 -1

## Advantages

- Easy assembly without milling
- Subsequent height adjustment 50, 100 or 150 mm
- PediX 300+150 and PediX 300+150 HV allow constructive timber protection in accordance with the new DIN 68800-2
- High load-bearing capacity according to ETA-13/0550
- Additional constructive timber protection thanks to gasket on end grain
- Min. timber cross section of 100 x 100 mm
- Hot-dip galvanised S235JR (ST37-2) structural steel
- Meets the constructional wood preservation requirements and thus increases the wooden structure's longevity (protection against splash water)

## Assembly

- Simple assembly with fully threaded screws and no need for joinery work, pilot drilling or milling
- Comes supplied with 12 fully threaded A2 screws measuring 5,0 x 80 mm



Suitable for this:  
**Rock 6kt Bi-Metall A2 10,5 x 95 mm**  
 Art. no. 110355  
 Find more information on p. 390

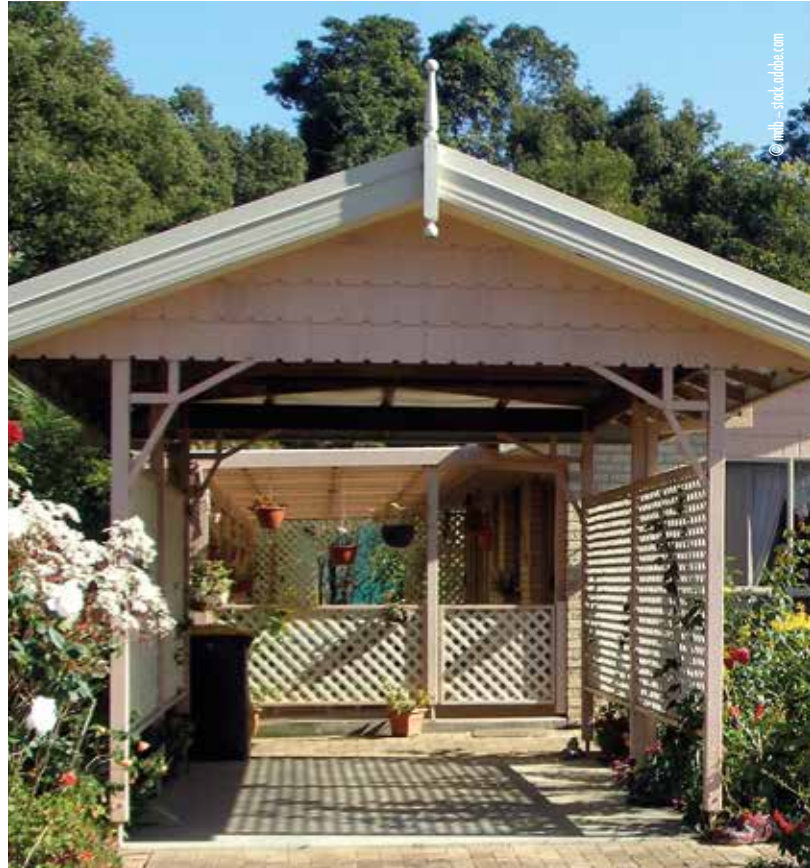













# PediX post feet

Technical data

Name	Art. no.	Height adjustment in assembled state	Min. post cross section	Dimensions of baseplate	Compressive loadbearing capacity	Tensile loadbearing capacity	Lateral force resistance <sup>1)</sup>	PU
Post feet on concrete		[mm]	[mm]	H x L x W [mm]	$N_{c,d}$ [kN]	$N_{t,d}$ [kN]	$V_{R,d}$ [kN]	pcs.
PediX 140+50 	904681	140 - 190	100 x 100	8 x 160 x 100	48,0	9,2	-	4
PediX 190+100 	904682	190 - 290	100 x 100	8 x 160 x 100	30,9	9,2	-	4
PediX 300+150 	904689	300 - 450	100 x 100	8 x 160 x 100	16,2	9,2	-	4
PediX 140+50 HV 	904681-HV	140 - 190	100 x 100	8 x 160 x 100	48,0	9,2	3,5	4
PediX 190+100 HV 	904682-HV	190 - 290	100 x 100	8 x 160 x 100	35,4	9,2	2,9	4
PediX 300+150 HV 	904689-HV	300 - 450	100 x 100	8 x 160 x 100	34,5	8,6	2,3	4
Post feet in concrete		Height adjustability [mm]	[mm]	H x L x W [mm]	$N_{c,d}$ [kN]	$N_{t,d}$ [kN]	$V_{R,d}$ [kN]	pcs.
PediX B500 	904683	-	100 x 100	-	49,0	24	4,6	4
PediX B500+50 	904686	50	100 x 100	-	44,9	23	-	4

1) The lateral force resistance must be overlaid with the compressive and tensile load in accordance with ETA-13-/0550 and can therefore lead to lower load-bearing capacities.

Please note: The stated values are only intended as planning aids. They are subject to typographical and printing errors. Projects must only be calculated by authorised persons.

## Installation instructions: You will find more-detailed information in our installation instructions

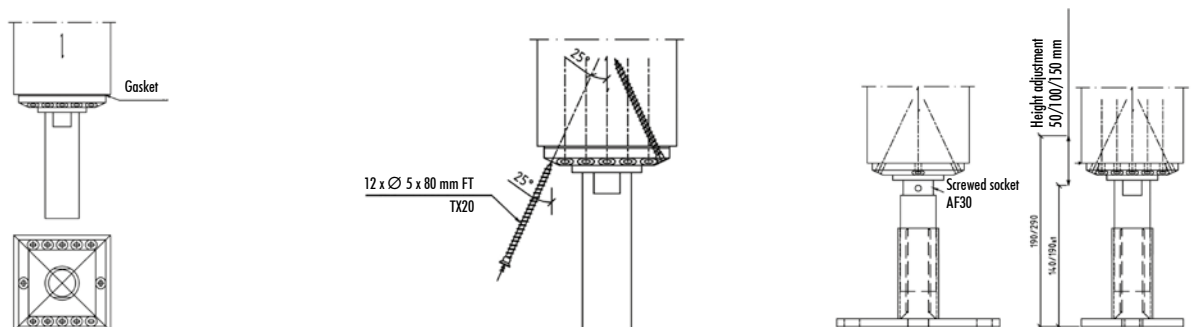

The PediX post foot can be attached easily to the end grain. Place the seal on the support foot and then place both parts centrally on the end grain surface.  
Note: To make assembly easier, the base plate and the cover sleeve can be unscrewed.

After centring the head plate, screw in the 12 A2 full-thread 5,0 x 80 mm screws at an angle of 25° without base plate.

The protective sleeve and the pilot drilling can be reinstalled after all screws are fitted. After the post is erected with the post foot installed, it can be anchored on a concrete foundation with two or four cavity-wall ties or concrete bolts. Once the foot is installed on the socket, its height can be adjusted using an AF30 spanner.

Please note: Do not screw the post foot to a height greater than 190, 290 or 450 mm respectively.

# PediX Easy 135+65 / 200+100

## PediX Easy 135+65 / 200+100



### Advantages / Properties

- Simple assembly with fully threaded screws without any need for joinery work, pilot drilling or milling
- Min. timber cross-section: 100 x 100 mm
- Can be used in service classes 1, 2 and 3 according to DIN EN 1995-1-1
- Can also absorb horizontal loads

### Description

The PediX Easy 135+65 and PediX Easy 200+100 are post supports for lightweight timber structures that meet structural wood preservation requirements. They can be assembled on the end grain without any need for additional joinery work or pilot drilling using fully threaded screws. Following assembly, the height of the support pedestals can still be adjusted by 65 mm or 100 mm. Thanks to the height adjustment, manufacturing tolerances relating to the structure and subsequent settlement in the individual foundations can be balanced out. The PediX Easy 135+65 and PediX Easy 200+100 can also absorb horizontal loads. The pedestal's durability is guaranteed by a zinc/nickel coating

Art. no.	Designation	Dimensions of the baseplate [mm] <sup>a)</sup>	Height adjustment in assembled state	PU*
904678	PediX Easy 135+65	160 x 100 x 6	135 - 200	4
904684	PediX Easy 200+100	160 x 100 x 6	200 - 300	4

a) Length x width x height  
Delivery incl. twelve A2 fully threaded screws (Ø 5.0 x 80 mm) per post support



# PediX Duo 150+45 / 190+80

## PediX Duo 150+45 / 190+80



### Advantages / Properties

- Simple assembly with fully threaded screws without any need for joinery work, pilot drilling or milling
- The bayonet lock makes assembling the support pedestal and the structure extremely easy
- Two-part structure
- Min. timber cross-section: 100 x 100 mm
- Can be used in service classes 1, 2 and 3 according to DIN EN 1995-1-1

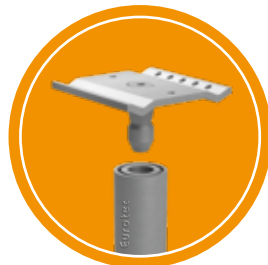

### Description

The PediX Duo 150+45 and PediX Duo 190+80 are post supports for lightweight timber structures that meet structural wood preservation requirements. The pedestals' durability is guaranteed by a zinc/nickel coating. The post supports can be assembled on the support's end grain without any need for additional joinery work or pilot drilling using fully threaded screws. The bayonet lock permits extremely easy assembly of the top part with the assembled support and the anchored bottom part. The connection is locked by plugging in and pulling up the lock. The connection established in this way can even transfer tensile forces from the support to the foundation. Following assembly, the height of the support pedestal can still be adjusted by 45 mm or 80 mm. If you have any further questions about assembly, please refer to our assembly instructions or contact our Application Engineering Department (Technik@eurotec.team)

Art. no.	Designation	Dimensions of the baseplate [mm] <sup>a)</sup>	Height adjustment in assembled state	PU*
904679	PediX Duo 150+45	160 x 100 x 8	150 - 195	4
904680	PediX Duo 190+80	160 x 100 x 8	190 - 270	4

a) Length x width x height

Delivery incl. twelve A2 fully threaded screws (Ø 5.0 x 80 mm) per post support

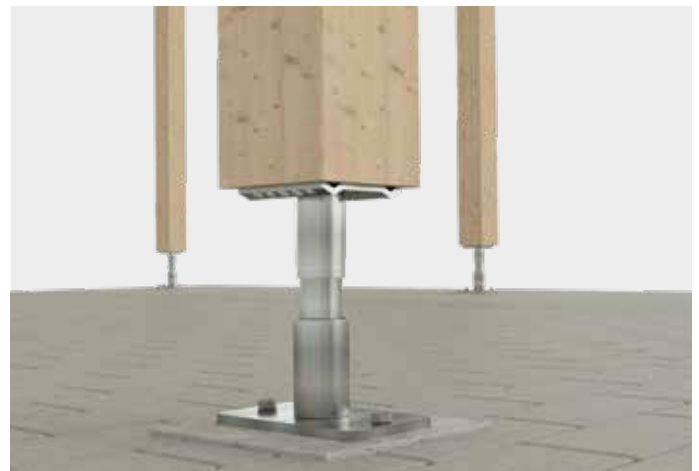

# BRUTUS threaded rod

Fully threaded rod for transverse-shear reinforcement in laminated wood joists



## What can it be used for?

- For large timber components such as building trusses
- For use in new and existing properties
- Allow larger spans and narrower timber cross sections in new constructions

## Advantages

- BRUTUS threaded rods absorb transverse-shear forces!
- Transverse-shear reinforcement
  - of building trusses
  - at notches and openings
  - at transverse connections

## Assembly

- Shorten BRUTUS threaded rod to any desired length
- Pilot-drill to  $\varnothing$  13 mm
- Care must be taken to avoid drill wander when drilling the holes

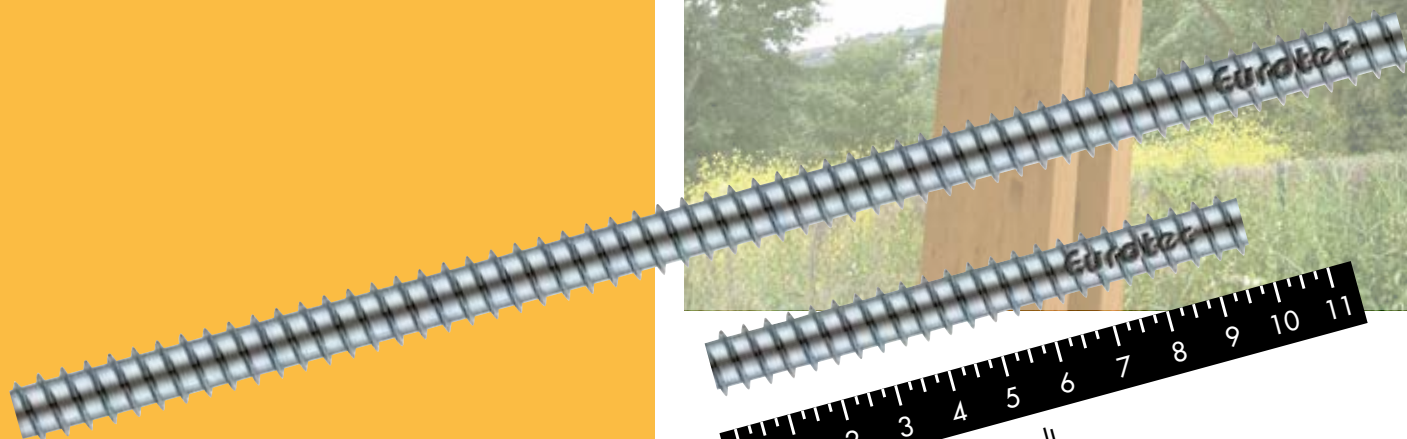

Can be shortened as required!



## Brutus threaded rod

Grade 8.8 steel, Galvanised steel



Art. no.	Dimensions [mm]	PU
945247	16 x 3000	1



### Things to bear in mind

- Pilot-drill to Ø 13 mm
- The drill bit can wander while drilling deeper holes



## Insertion tool

Suitable for this



Art. no.	PU
945318	1

## BRUTUS drilling system

Art. no.	PU
945279	1



Suitable for pre-drilling the BRUTUS threaded rod

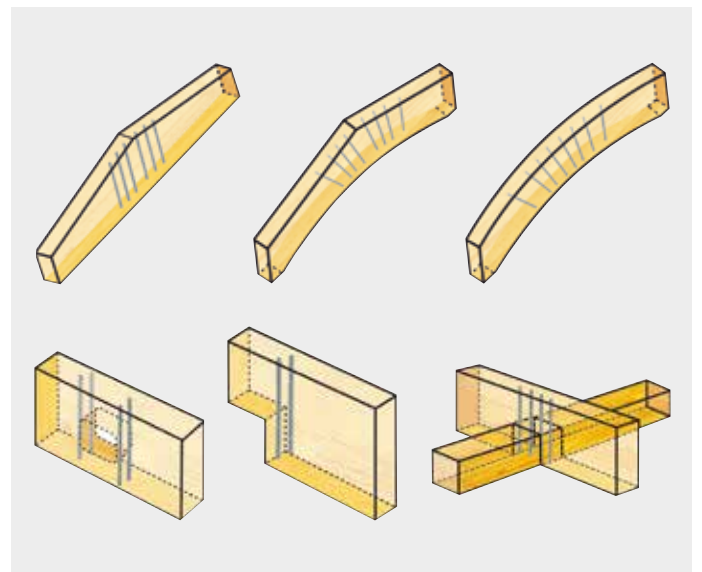

# KonstruX fully threaded screws

The powerful solution for construction and renovation



## What can it be used for?

- For all timber-frame construction joints
- Timber engineering
- Carpentry
- Timber-frame construction
- Construction of timber elements
- Hall construction
- Renovation of ceilings

## Properties

- Maximum load transmission
- High fire-resistance
- No thermal bridges

## Advantages

- High extraction resistance
- Strong joints
- Maximisation of the load-bearing capacity
- A time- and cost-saving alternative
- Hidden connections
- No pre-drilling required according to approval / ETA (recommended from screw lengths  $\geq 245$  mm)

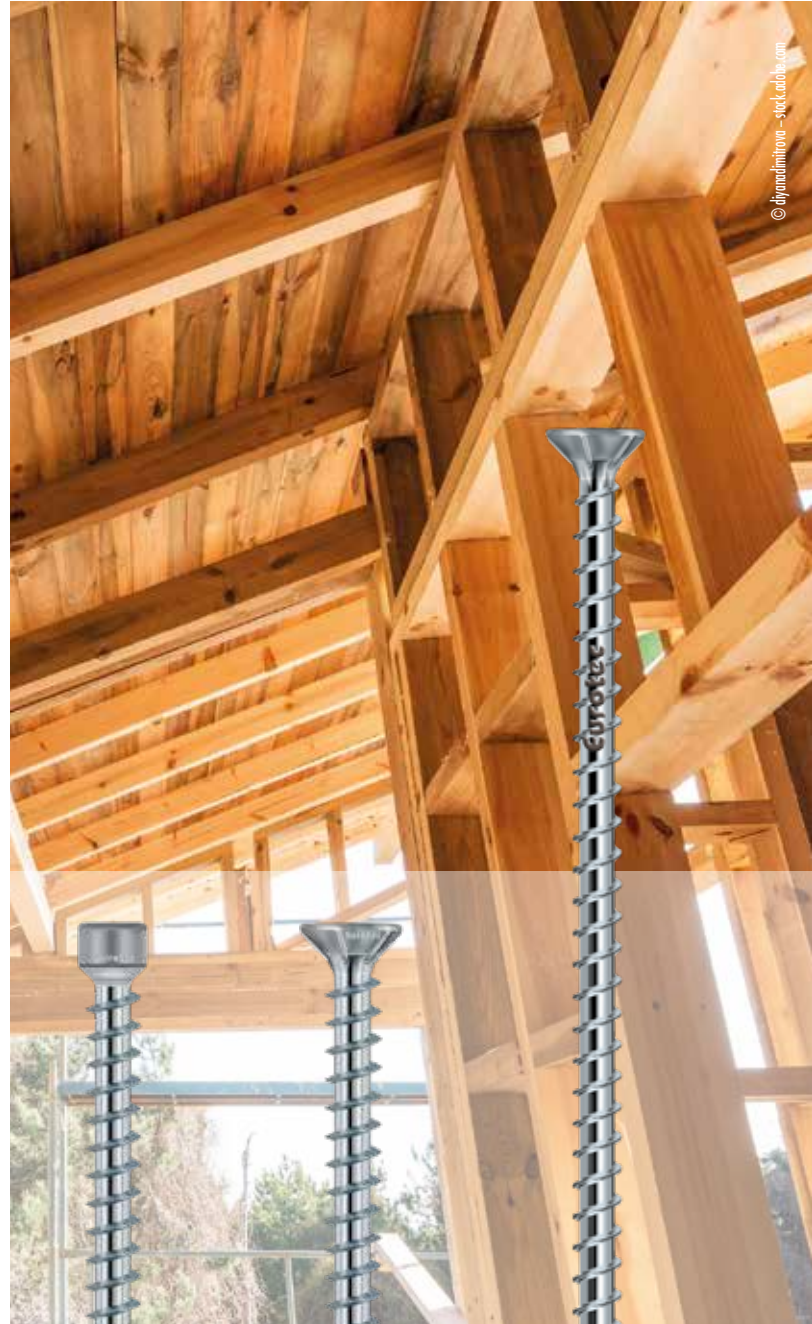

KonstruX ST  
cylinder head,  
galvanised

KonstruX ST  
countersunk head,  
galvanised

KonstruX  
countersunk head,  
galvanised

### KonstruX ST fully threaded screw

Cylinder head, galvanised



**Benefits of drill point**

- Reduced screwing torque
- High extraction resistance



Art. no.	Dimensions [mm]	Drive	PU
904808	6,5 x 80	TX30 ●	100
904809	6,5 x 100	TX30 ●	100
904810	6,5 x 120	TX30 ●	100
904811	6,5 x 140	TX30 ●	100
904812	6,5 x 160	TX30 ●	100
904813	6,5 x 195	TX30 ●	100
904825	8,0 x 155	TX40 ●	50
904826	8,0 x 195	TX40 ●	50
904827	8,0 x 220	TX40 ●	50
904828	8,0 x 245	TX40 ●	50
904834	8,0 x 270	TX40 ●	50
904829	8,0 x 295	TX40 ●	50
904830	8,0 x 330	TX40 ●	50
904831	8,0 x 375	TX40 ●	50
904832	8,0 x 400	TX40 ●	50
944804	8,0 x 430	TX40 ●	50
944805	8,0 x 480	TX40 ●	50
944806	8,0 x 530	TX40 ●	50
944807	8,0 x 580	TX40 ●	50
904815	10,0 x 300	TX50 ●	25
904816	10,0 x 330	TX50 ●	25
904817	10,0 x 360	TX50 ●	25
904818	10,0 x 400	TX50 ●	25
904819	10,0 x 450	TX50 ●	25
904820	10,0 x 500	TX50 ●	25
904821	10,0 x 550	TX50 ●	25
904822	10,0 x 600	TX50 ●	25

### KonstruX ST fully threaded screw

Countersunk head, galvanised

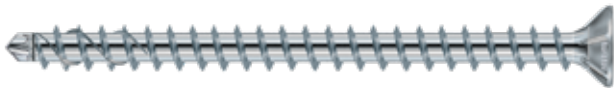

**Benefits of drill point**

- Reduced screwing torque
- High extraction resistance



Art. no.	Dimensions [mm]	Drive	PU
904857	6,5 x 80	TX30 ●	100
904858	6,5 x 100	TX30 ●	100
904859	6,5 x 120	TX30 ●	100
904860	6,5 x 140	TX30 ●	100
904790	8,0 x 95	TX40 ●	50
904791	8,0 x 125	TX40 ●	50
904792	8,0 x 155	TX40 ●	50
904793	8,0 x 195	TX40 ●	50
904794	8,0 x 220	TX40 ●	50
904795	8,0 x 245	TX40 ●	50
904796	8,0 x 270	TX40 ●	50
904797	8,0 x 295	TX40 ●	50
904798	8,0 x 330	TX40 ●	50
904799	8,0 x 375	TX40 ●	50
904800	8,0 x 400	TX40 ●	50
904801	8,0 x 430	TX40 ●	50
904802	8,0 x 480	TX40 ●	50
904803	8,0 x 545	TX40 ●	50
904770	10,0 x 125	TX50 ●	25
904771	10,0 x 155	TX50 ●	25
904772	10,0 x 195	TX50 ●	25
904773	10,0 x 220	TX50 ●	25
904774	10,0 x 245	TX50 ●	25
904775	10,0 x 270	TX50 ●	25
904776	10,0 x 300	TX50 ●	25
904777	10,0 x 330	TX50 ●	25
904778	10,0 x 360	TX50 ●	25
904779	10,0 x 400	TX50 ●	25
904780	10,0 x 450	TX50 ●	25
904781	10,0 x 500	TX50 ●	25
904782	10,0 x 550	TX50 ●	25
904783	10,0 x 600	TX50 ●	25



## KonstruX fully threaded screw

Countersunk head, galvanised



### Advantages AG screw tip

- Faster and easier screwing
- Reduced splitting effect



Art. no.	Dimensions [mm]	Drive	PU
905737	11,3 x 300	TX50 •	20
905738	11,3 x 340	TX50 •	20
905739	11,3 x 380	TX50 •	20
905740	11,3 x 420	TX50 •	20
905741	11,3 x 460	TX50 •	20
905742	11,3 x 500	TX50 •	20
905743	11,3 x 540	TX50 •	20
905744	11,3 x 580	TX50 •	20
905745	11,3 x 620	TX50 •	20
905746	11,3 x 660	TX50 •	20
905747	11,3 x 700	TX50 •	20
905748	11,3 x 750	TX50 •	20
905749	11,3 x 800	TX50 •	20
904750	11,3 x 900	TX50 •	20
904751	11,3 x 1000	TX50 •	20

## KonstruX fully threaded screw

Countersunk-head screw, A4

Stainless Steel



Art. no.	Dimensions [mm]	Drive	PU
905750	10,0 x 160	TX50 •	25
905751	10,0 x 200	TX50 •	25
905752	10,0 x 220	TX50 •	25
905753	10,0 x 240	TX50 •	25
905754	10,0 x 260	TX50 •	25
905755	10,0 x 280	TX50 •	25
905756	10,0 x 300	TX50 •	25
905757	10,0 x 350	TX50 •	25
905758	10,0 x 400	TX50 •	25





## ECS calculation program for KonstruX

This user-friendly software allows pre-calculation of main/secondary beam connections, joist doubling and reinforcements of supports. Verifiable calculation aid in accordance with EN 1995 (Eurocode 5) and DIN 1052.

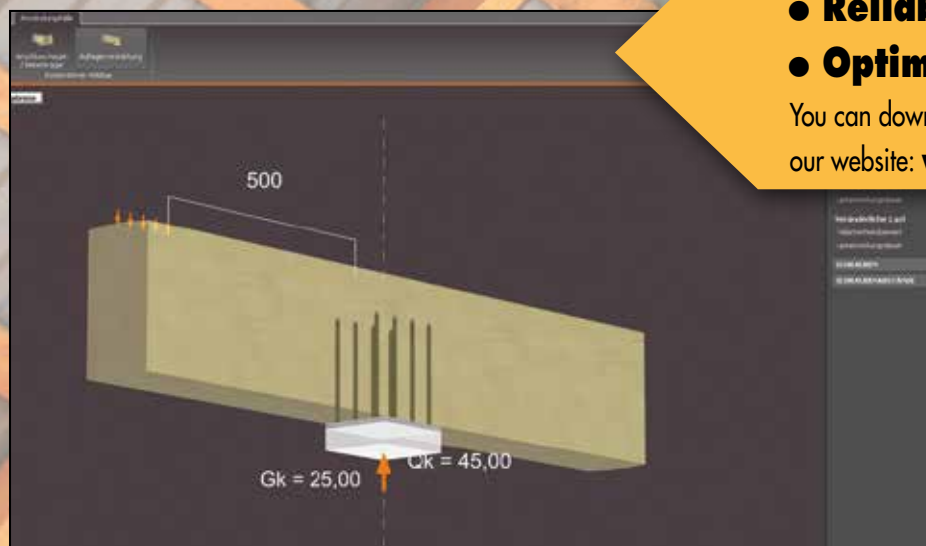
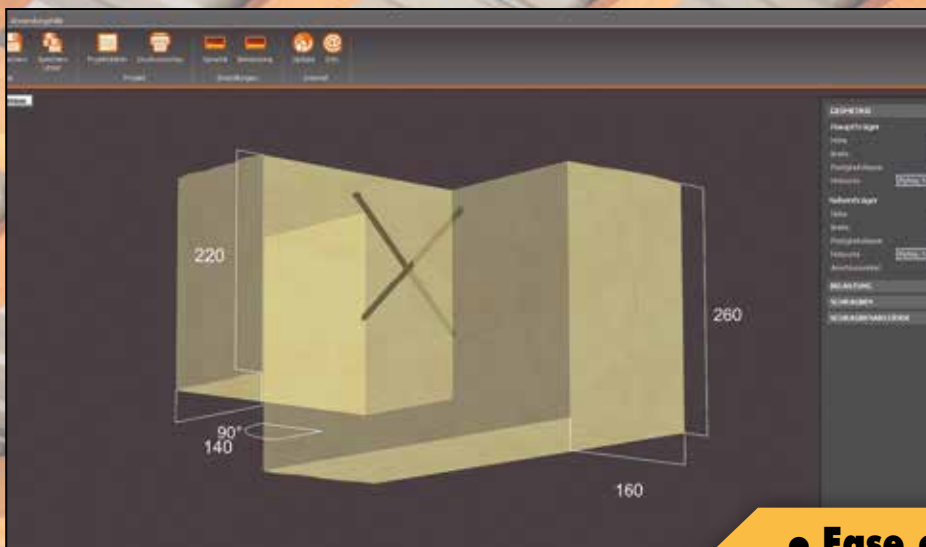

- **Ease of use**
- **Reliable planning**
- **Optimisation**

You can download the ECS software for free from our website: [www.eurotec.team/en](http://www.eurotec.team/en)

# The fast and secure timber-joint system

## KonstruX cylinder-head/countersunk-head screws

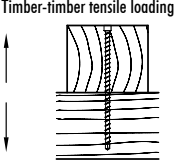
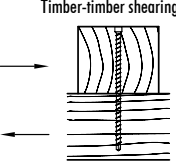
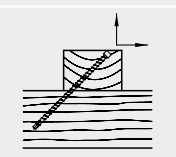
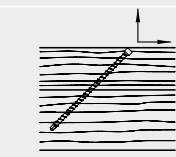
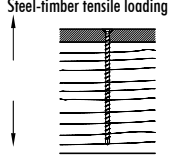
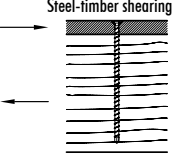
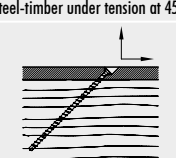
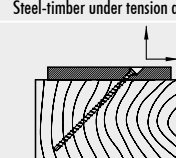
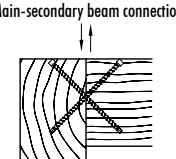
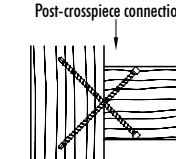
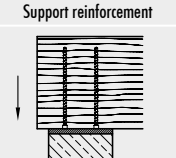
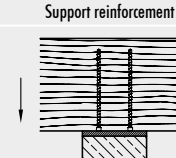
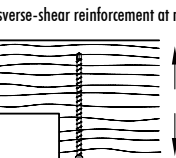
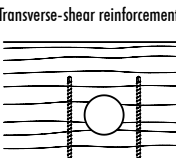
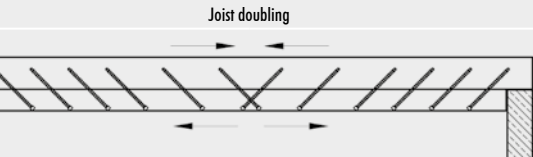
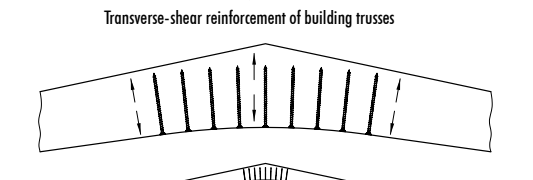
Example applications		Cylinder head			Countersunk head			
		Ø 6,5 [mm]	Ø 8,0 [mm]	Ø 10,0 [mm]	Ø 6,5 [mm]	Ø 8,0 [mm]	Ø 10,0 [mm]	Ø 11,3 [mm]
 <p>Timber-timber tensile loading</p>	 <p>Timber-timber shearing</p>	×	×	×	×	×	×	×
 <p>Timber-timber under tension at 45°</p>	 <p>Timber-timber under tension at 45°</p>	×	×	×	×	×	×	×
 <p>Steel-timber tensile loading</p>	 <p>Steel-timber shearing</p>	—	—	—	×	×	×	×
 <p>Steel-timber under tension at 45°</p>	 <p>Steel-timber under tension at 45°</p>	—	—	—	×	×	×	×
 <p>Main-secondary beam connection</p>	 <p>Post-crosspiece connection</p>	×	×	×	×	×	×	—
 <p>Support reinforcement</p>	 <p>Support reinforcement</p>	×	×	×	×	×	×	×
 <p>Transverse-shear reinforcement at notch</p>	 <p>Transverse-shear reinforcement at hole</p>	×	×	×	×	×	×	×
 <p>Joist doubling</p>		—	×	×	—	×	×	×
 <p>Transverse-shear reinforcement of building trusses</p>		—	—	×	—	—	×	×



# KonstruX fully threaded screw

Technical information

## KonstruX ST with cylinder head and drill point 6,5 to 10,0 mm: timber/timber joints

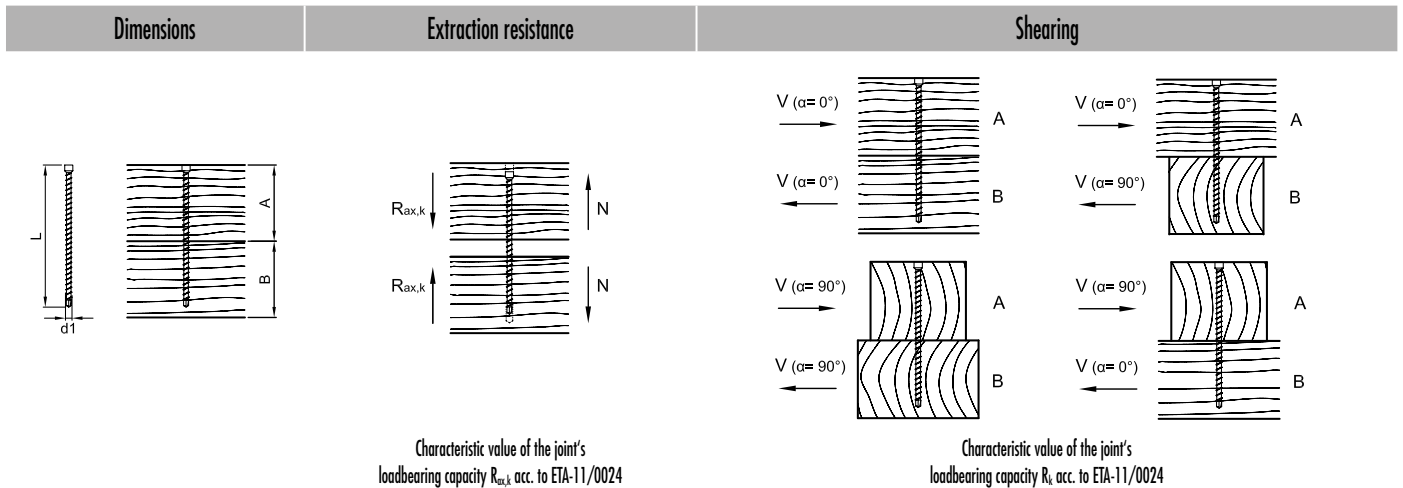

d1 x L [mm]	A [mm]	B [mm]	R <sub>ax,k</sub> <sup>a)</sup> - [kN]	Characteristic value of the joint's loadbearing capacity R <sub>k</sub> acc. to ETA-11/0024				
				R <sub>k</sub> <sup>a)</sup> - [kN]	R <sub>k</sub> <sup>a)</sup> - [kN]		R <sub>k</sub> <sup>a)</sup> - [kN]	
					α = 0°	α = 90°		α <sub>A</sub> = 0°
					α <sub>B</sub> = 90°	α <sub>B</sub> = 0°		
6,5 x 120	60	80	4,75	3,93	3,47		3,93	3,47
6,5 x 140	80	80	4,75	3,93	3,47		3,47	3,93
6,5 x 160	80	100	6,33	4,32	3,86		4,32	3,86
6,5 x 195	100	100	7,52	4,62	4,16		4,16	4,62
8,0 x 155	80	80	7,11	5,67	4,99		4,99	5,67
8,0 x 195	100	100	9,01	6,15	5,46		5,46	6,15
8,0 x 220	120	120	9,48	6,27	5,58		5,58	6,27
8,0 x 245	120	140	11,38	6,74	6,06		6,74	6,06
8,0 x 295	140	160	13,28	7,21	6,42		7,21	6,42
8,0 x 330	160	180	15,17	7,69	6,42		7,69	6,42
8,0 x 375	180	200	17,07	7,79	6,42		7,79	6,42
8,0 x 400	200	220	18,97	7,79	6,42		7,79	6,42
8,0 x 430	220	220	19,92	7,79	6,42		6,42	7,79
8,0 x 480	240	260	22,76	7,79	6,42		7,79	6,42
10,0 x 300	160	160	16,15	9,48	8,48		8,48	9,48
10,0 x 330	160	180	18,46	10,06	8,90		10,06	8,90
10,0 x 360	180	200	20,76	10,64	8,90		10,64	8,90
10,0 x 400	200	220	23,07	10,89	8,90		10,89	8,90
10,0 x 450	220	240	25,38	10,89	8,90		10,89	8,90
10,0 x 500	240	280	27,68	10,89	8,90		10,89	8,90
10,0 x 550	260	300	29,99	10,89	8,90		10,89	8,90
10,0 x 600	300	320	33,00	10,89	8,90		10,89	8,90

Calculation according to ETA-11/0024. Wood density ρ<sub>k</sub> = 380 kg/m³. All mechanical values provided should be viewed as subject to the assumptions that have been made and represent example calculations.

All values are calculated minimum values and are subject to typographical and printing errors.

a) The characteristic values of the load-bearing capacity R<sub>k</sub> cannot be treated as equivalent to the max. possible load (the max. force). Characteristic values of the load-bearing capacity R<sub>k</sub> should be reduced to dimensioning values R<sub>d</sub> with regard to the usage class and class of the load duration: R<sub>d</sub> = R<sub>k</sub> · k<sub>mod</sub> / γ<sub>M</sub>. The dimensioning values of the load-bearing capacity R<sub>d</sub> should be contrasted with the dimensioning values of the loads (R<sub>d</sub> ≥ E<sub>d</sub>).

### Example:

Characteristic value for constant load (dead weight) G<sub>k</sub> = 2,00 kN and variable load (e. g. snow load) Q<sub>k</sub> = 3,00 kN. k<sub>mod</sub> = 0,9. γ<sub>M</sub> = 1,3.

→ Dimensioning value of the load E<sub>d</sub> = 2,00 · 1,35 + 3,00 · 1,5 = 7,20 kN.

The load-bearing capacity of the joint is therefore considered to have been demonstrated if R<sub>d</sub> ≥ E<sub>d</sub>. → min R<sub>d</sub> = R<sub>k</sub> · γ<sub>M</sub> / k<sub>mod</sub>

i.e. the characteristic minimum value is calculated based on: min R<sub>k</sub> = R<sub>d</sub> · k<sub>mod</sub> / γ<sub>M</sub> → R<sub>k</sub> = 7,20 kN · 1,3/0,9 = 10,40 kN → comparison with table values.

Please note: These are planning aids. Projects must only be calculated by authorised persons.

# KonstruX ST with cylinder head and drill point 6,5 to 10,0 mm: timber/timber joints

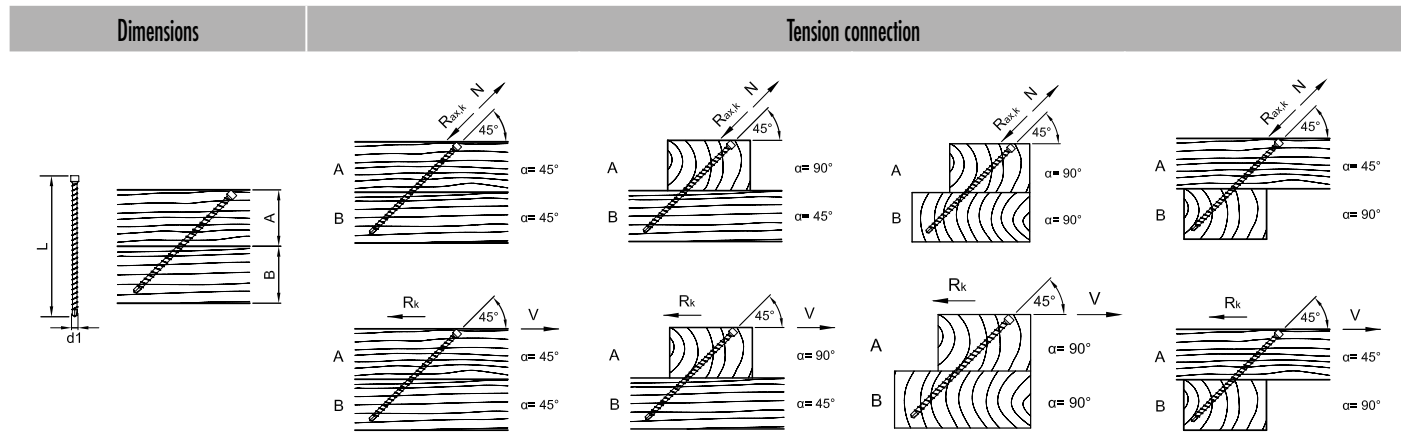

Characteristic value of the joint's load-bearing capacity  $R_{ox,k}$  bzw.  $R_k$  acc. to ETA-11/0024

d1 x L [mm]	A [mm]	B [mm]	$\alpha = 45^\circ$		$\alpha_A = 90^\circ$ $\alpha_B = 45^\circ$		$\alpha_A = 90^\circ$ $\alpha_B = 90^\circ$		$\alpha_A = 45^\circ$ $\alpha_B = 90^\circ$	
			$R_{ox,k}^{01}$ - [kN]	$R_k^{01}$ - [kN]	$R_{ox,k}^{01}$ - [kN]	$R_k^{01}$ - [kN]	$R_{ox,k}^{01}$ - [kN]	$R_k^{01}$ - [kN]	$R_{ox,k}^{01}$ - [kN]	$R_k^{01}$ - [kN]
6,5 x 160	60	80	5,95	4,21	5,95	4,21	5,95	4,21	5,95	4,21
6,5 x 195	80	80	6,48	4,58	6,48	4,58	6,48	4,58	6,48	4,58
8,0 x 155	60	60	6,65	4,70	6,65	4,70	6,65	4,70	6,65	4,70
8,0 x 195	80	80	7,76	5,49	7,76	5,49	7,76	5,49	7,76	5,49
8,0 x 220	80	100	10,13	7,17	10,13	7,17	10,13	7,17	10,13	7,17
8,0 x 245	100	100	9,82	6,95	9,82	6,95	9,82	6,95	9,82	6,95
8,0 x 295	120	100	11,88	8,40	11,88	8,40	11,88	8,40	11,88	8,40
8,0 x 330	120	140	15,20	10,75	15,20	10,75	15,20	10,75	15,20	10,75
8,0 x 375	140	140	16,79	11,87	16,79	11,87	16,79	11,87	16,79	11,87
8,0 x 400	160	140	16,48	11,65	16,48	11,65	16,48	11,65	16,48	11,65
8,0 x 430	160	160	19,32	13,66	19,32	13,66	19,32	13,66	19,32	13,66
8,0 x 480	180	180	21,38	15,12	21,38	15,12	21,38	15,12	21,38	15,12
10,0 x 300	120	120	15,03	10,63	15,03	10,63	15,03	10,63	15,03	10,63
10,0 x 330	120	140	18,49	13,07	18,49	13,07	18,49	13,07	18,49	13,07
10,0 x 360	140	140	18,69	13,21	18,69	13,21	18,69	13,21	18,69	13,21
10,0 x 400	160	140	20,04	14,17	20,04	14,17	20,04	14,17	20,04	14,17
10,0 x 450	160	180	25,81	18,25	25,81	18,25	25,81	18,25	25,81	18,25
10,0 x 500	180	200	28,31	20,02	28,31	20,02	28,31	20,02	28,31	20,02
10,0 x 550	200	200	30,82	21,79	30,82	21,79	30,82	21,79	30,82	21,79
10,0 x 600	220	220	33,00	23,33	33,00	23,33	33,00	23,33	33,00	23,33

Calculation according to ETA-11/0024. Wood density  $\rho_k = 380 \text{ kg/m}^3$ . All mechanical values provided should be viewed as subject to the assumptions that have been made and represent example calculations.

All values are calculated minimum values and are subject to typographical and printing errors.

a) The characteristic values of the load-bearing capacity  $R_k$  cannot be treated as equivalent to the max. possible load (the max. force). Characteristic values of the load-bearing capacity  $R_k$  should be reduced to dimensioning values  $R_d$  with regard to the usage class and class of the load duration:  $R_d = R_k \cdot k_{mod} / \gamma_M$ . The dimensioning values of the load-bearing capacity  $R_d$  should be contrasted with the dimensioning values of the loads ( $R_d \geq E_d$ ).

### Example:

Characteristic value for constant load (dead weight)  $G_k = 2,00 \text{ kN}$  and variable load (e. g. snow load)  $Q_k = 3,00 \text{ kN}$ .  $k_{mod} = 0,9$ .  $\gamma_M = 1,3$ .

→ Dimensioning value of the load  $E_d = 2,00 \cdot 1,35 + 3,00 \cdot 1,5 = 7,20 \text{ kN}$ .

The load-bearing capacity of the joint is therefore considered to have been demonstrated if  $R_d \geq E_d$ . →  $\min R_k = R_d \cdot \gamma_M / k_{mod}$

i.e. the characteristic minimum value is calculated based on:  $\min R_k = R_d \cdot \gamma_M / k_{mod} \rightarrow R_k = 7,20 \text{ kN} \cdot 1,3 / 0,9 = 10,40 \text{ kN}$  → comparison with table values.

Please note: These are planning aids. Projects must only be calculated by authorised persons.



# KonstruX ST with countersunk head and drill point 6,5 to 10,0 mm: timber/timber joints

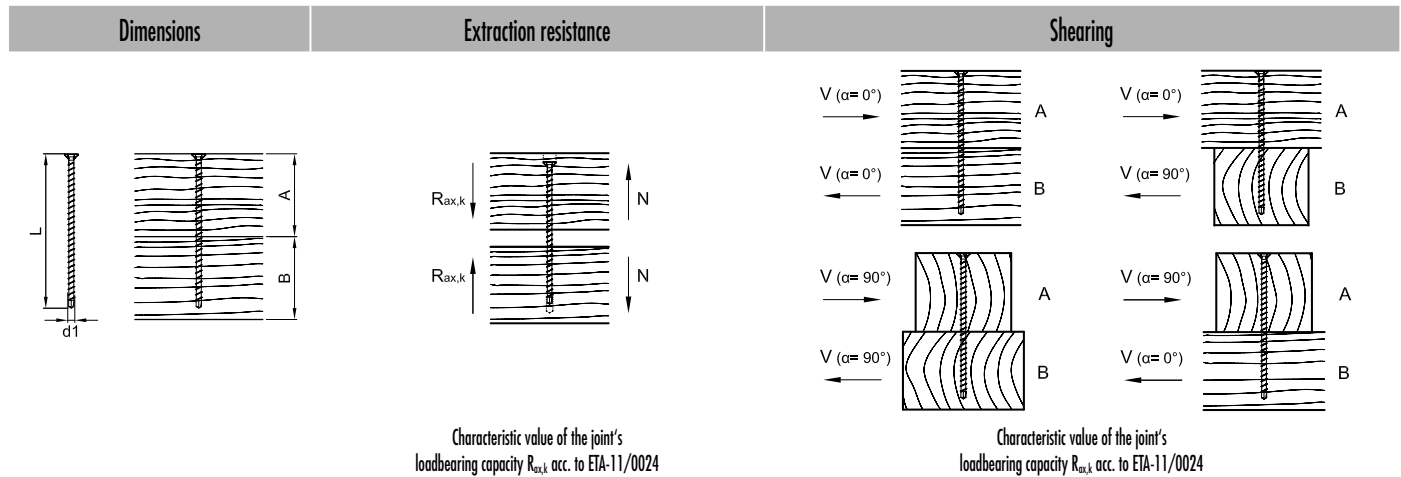

Characteristic value of the joint's loadbearing capacity  $R_{ax,k}$  acc. to ETA-11/0024

Characteristic value of the joint's loadbearing capacity  $R_k$  acc. to ETA-11/0024

d1 x L [mm]	A [mm]	B [mm]	$R_{ax,k}^{a)}$ - [kN]	$R_k^{a)}$ - [kN]				
				$\alpha = 0^\circ$	$\alpha = 90^\circ$	$\alpha_A = 0^\circ$		$\alpha_A = 90^\circ$
						$\alpha_B = 90^\circ$	$\alpha_B = 0^\circ$	
6,5 x 120	60	80	4,75	3,93	3,47	3,93	3,47	
6,5 x 140	80	80	4,75	3,93	3,47	3,47	3,93	
8,0 x 95	40	60	3,08	4,61	3,57	4,61	3,57	
8,0 x 125	60	80	4,61	5,05	4,37	5,05	4,37	
8,0 x 155	80	80	7,11	5,67	4,99	4,99	5,67	
8,0 x 195	100	100	9,01	6,15	5,46	5,46	6,15	
8,0 x 220	120	120	9,48	6,27	5,58	5,58	6,27	
8,0 x 245	120	140	11,38	6,74	6,06	6,74	6,06	
8,0 x 270	140	140	12,33	6,98	6,29	6,29	6,98	
8,0 x 295	140	160	13,28	7,21	6,42	7,21	6,42	
8,0 x 330	160	180	15,17	7,69	6,42	7,69	6,42	
8,0 x 375	180	200	17,07	7,79	6,42	7,79	6,42	
8,0 x 400	200	220	18,97	7,79	6,42	7,79	6,42	
8,0 x 430	220	220	19,92	7,79	6,42	6,42	7,79	
8,0 x 480	240	260	22,76	7,79	6,42	7,79	6,42	
10,0 x 125	60	80	6,92	7,18	6,18	7,18	6,18	
10,0 x 155	80	80	8,65	7,61	6,61	6,61	7,61	
10,0 x 195	100	100	10,96	8,19	7,19	7,19	8,19	
10,0 x 220	120	120	11,53	8,33	7,33	7,33	8,33	
10,0 x 245	120	140	13,84	8,91	7,91	8,91	7,91	
10,0 x 270	140	140	14,99	9,20	8,20	8,20	9,20	
10,0 x 300	160	160	16,15	9,48	8,48	8,48	9,48	
10,0 x 330	160	180	18,46	10,06	8,90	10,06	8,90	
10,0 x 360	180	200	20,76	10,64	8,90	10,64	8,90	
10,0 x 400	200	220	23,07	10,89	8,90	10,89	8,90	
10,0 x 450	220	240	25,38	10,89	8,90	10,89	8,90	
10,0 x 500	240	280	27,68	10,89	8,90	10,89	8,90	
10,0 x 550	260	300	29,99	10,89	8,90	10,89	8,90	
10,0 x 600	300	320	33,00	10,89	8,90	10,89	8,90	

Calculation according to ETA-11/0024. Wood density  $\rho_k = 380 \text{ kg/m}^3$ . All mechanical values provided should be viewed as subject to the assumptions that have been made and represent example calculations.

All values are calculated minimum values and are subject to typographical and printing errors.

a) The characteristic values of the load-bearing capacity  $R_k$  cannot be treated as equivalent to the max. possible load (the max. force). Characteristic values of the load-bearing capacity  $R_k$  should be reduced to dimensioning values  $R_d$  with regard to the usage class and class of the load duration:  $R_d = R_k \cdot k_{mod} / \gamma_M$ . The dimensioning values of the load-bearing capacity  $R_d$  should be contrasted with the dimensioning values of the loads ( $R_d \geq E_d$ ).

### Example:

Characteristic value for constant load (dead weight)  $G_k = 2,00 \text{ kN}$  and variable load (e. g. snow load)  $Q_k = 3,00 \text{ kN}$ .  $k_{mod} = 0,9$ .  $\gamma_M = 1,3$ .  $\rightarrow$  Dimensioning value of the load  $E_d = 2,00 \cdot 1,35 + 3,00 \cdot 1,5 = 7,20 \text{ kN}$ . The load-bearing capacity of the joint is therefore considered to have been demonstrated if  $R_d \geq E_d$ .  $\rightarrow \min R_k = R_d \cdot \gamma_M / k_{mod}$ . i.e. the characteristic minimum value is calculated based on:  $\min R_k = R_d \cdot \gamma_M / k_{mod} \rightarrow R_k = 7,20 \text{ kN} \cdot 1,3 / 0,9 = 10,40 \text{ kN}$   $\rightarrow$  comparison with table values.

Please note: These are planning aids. Projects must only be calculated by authorised persons.

# KonstruX ST with countersunk head and drill point 8,0 and 10,0 mm: timber/timber joints

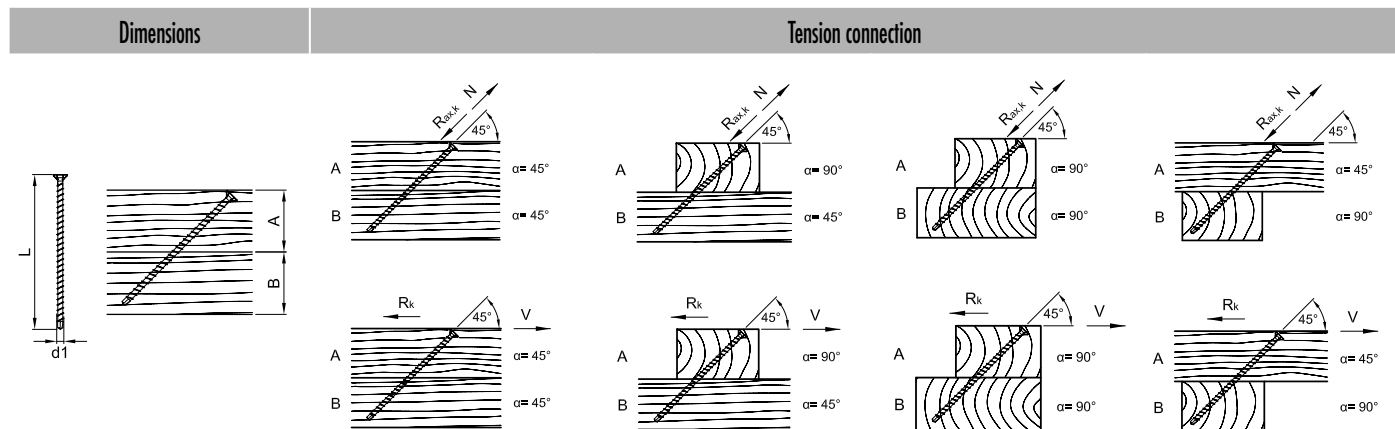

Characteristic value of the joint's loadbearing capacity  $R_{ox,k}$  bzw.  $R_k$  acc. to ETA-11/0024

$d1 \times L$ [mm]	A [mm]	B [mm]	$R_{ox,k}^{a)}$ - [kN]	$R_k^{a)}$ - [kN]	$R_{ox,k}^{a)}$ - [kN]	$R_k^{a)}$ - [kN]	$R_{ox,k}^{a)}$ - [kN]	$R_k^{a)}$ - [kN]	$R_{ox,k}^{a)}$ - [kN]	$R_k^{a)}$ - [kN]
			$\alpha = 45^\circ$		$\alpha_A = 90^\circ$ $\alpha_B = 45^\circ$		$\alpha_A = 90^\circ$ $\alpha_B = 90^\circ$		$\alpha_A = 45^\circ$ $\alpha_B = 90^\circ$	
8,0 x 155	60	60	6,65	4,70	6,65	4,70	6,65	4,70	6,65	4,70
8,0 x 195	80	80	7,76	5,49	7,76	5,49	7,76	5,49	7,76	5,49
8,0 x 220	80	100	10,13	7,17	10,13	7,17	10,13	7,17	10,13	7,17
8,0 x 245	100	100	9,82	6,95	9,82	6,95	9,82	6,95	9,82	6,95
8,0 x 270	100	120	12,19	8,62	12,19	8,62	12,19	8,62	12,19	8,62
8,0 x 295	120	100	11,88	8,40	11,88	8,40	11,88	8,40	11,88	8,40
8,0 x 330	120	140	15,20	10,75	15,20	10,75	15,20	10,75	15,20	10,75
8,0 x 375	140	140	16,79	11,87	16,79	11,87	16,79	11,87	16,79	11,87
8,0 x 400	160	140	16,48	11,65	16,48	11,65	16,48	11,65	16,48	11,65
8,0 x 430	160	160	19,32	13,66	19,32	13,66	19,32	13,66	19,32	13,66
8,0 x 480	180	180	21,38	15,12	21,38	15,12	21,38	15,12	21,38	15,12
10,0 x 220	80	100	12,33	8,72	12,33	8,72	12,33	8,72	12,33	8,72
10,0 x 245	100	100	11,95	8,45	11,95	8,45	11,95	8,45	11,95	8,45
10,0 x 270	100	120	14,83	10,49	14,83	10,49	14,83	10,49	14,83	10,49
10,0 x 300	120	120	15,03	10,63	15,03	10,63	15,03	10,63	15,03	10,63
10,0 x 330	120	140	18,49	13,07	18,49	13,07	18,49	13,07	18,49	13,07
10,0 x 360	140	140	18,69	13,21	18,69	13,21	18,69	13,21	18,69	13,21
10,0 x 400	160	140	20,04	14,17	20,04	14,17	20,04	14,17	20,04	14,17
10,0 x 450	160	180	25,81	18,25	25,81	18,25	25,81	18,25	25,81	18,25
10,0 x 500	180	200	28,31	20,02	28,31	20,02	28,31	20,02	28,31	20,02
10,0 x 550	200	200	30,82	21,79	30,82	21,79	30,82	21,79	30,82	21,79
10,0 x 600	220	220	33,00	23,33	33,00	23,33	33,00	23,33	33,00	23,33

Calculation according to ETA-11/0024. Wood density  $\rho_k = 380 \text{ kg/m}^3$ . All mechanical values provided should be viewed as subject to the assumptions that have been made and represent example calculations.

All values are calculated minimum values and are subject to typographical and printing errors.

a) The characteristic values of the load-bearing capacity  $R_k$  cannot be treated as equivalent to the max. possible load (the max. force). Characteristic values of the load-bearing capacity  $R_k$  should be reduced to dimensioning values  $R_d$  with regard to the usage class and class of the load duration:  $R_d = R_k \cdot k_{mod} / \gamma_M$ . The dimensioning values of the load-bearing capacity  $R_d$  should be contrasted with the dimensioning values of the loads ( $R_d \geq E_d$ ).

### Example:

Characteristic value for constant load (dead weight)  $G_k = 2,00 \text{ kN}$  and variable load (e. g. snow load)  $Q_k = 3,00 \text{ kN}$ .  $k_{mod} = 0,9$ ,  $\gamma_M = 1,3$ .

→ Dimensioning value of the load  $E_d = 2,00 \cdot 1,35 + 3,00 \cdot 1,5 = 7,20 \text{ kN}$ .

The load-bearing capacity of the joint is therefore considered to have been demonstrated if  $R_d \geq E_d \rightarrow \min R_k = R_d \cdot \gamma_M / k_{mod}$

i.e. the characteristic minimum value is calculated based on:  $\min R_k = R_d \cdot \gamma_M / k_{mod} \rightarrow R_k = 7,20 \text{ kN} \cdot 1,3 / 0,9 = 10,40 \text{ kN}$  → comparison with table values.

Please note: These are planning aids. Projects must only be calculated by authorised persons.

# KonstruX with countersunk head and drill point or AG tip 11,3 mm: timber/timber connection

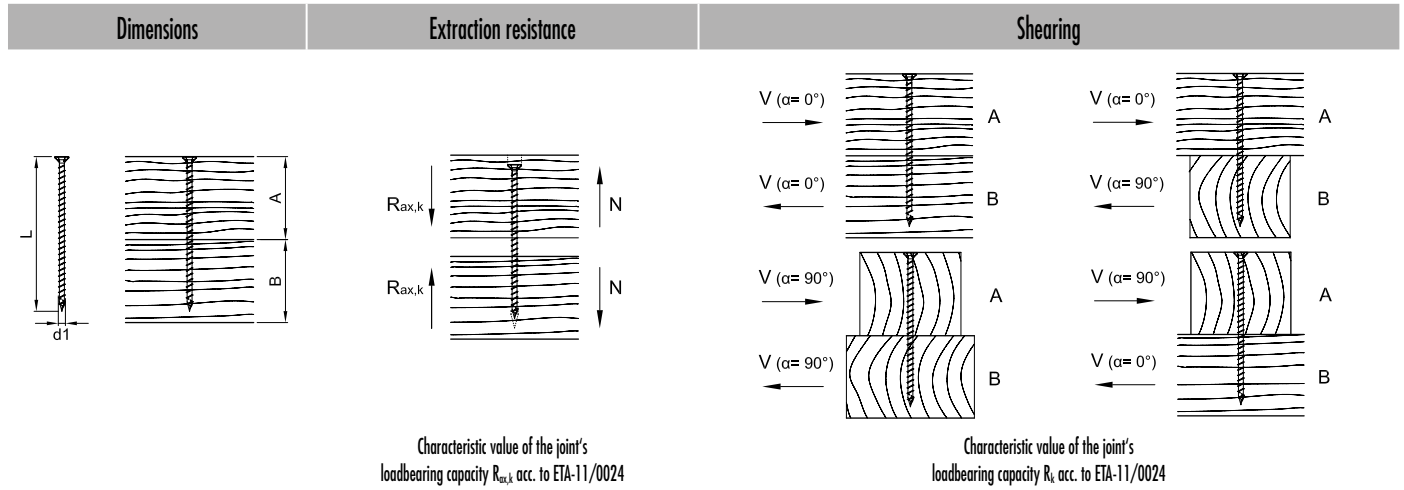

Characteristic value of the joint's loadbearing capacity  $R_{ax,k}$  acc. to ETA-11/0024

Characteristic value of the joint's loadbearing capacity  $R_k$  acc. to ETA-11/0024

d1 x L [mm]	A [mm]	B [mm]	$R_{ax,k}^{a)}$ - [kN]	$R_k^{a)}$ - [kN]			
				$\alpha = 0^\circ$	$\alpha = 90^\circ$	$\alpha_A = 0^\circ$	$\alpha_B = 90^\circ$
						$\alpha_A = 90^\circ$	$\alpha_B = 0^\circ$
11,3 x 300	160	160	18,25	12,17	10,73	10,73	12,17
11,3 x 340	180	180	20,85	12,82	11,38	11,38	12,82
11,3 x 380	200	200	23,46	13,47	12,03	12,03	13,47
11,3 x 420	220	220	26,07	14,12	12,34	12,34	14,12
11,3 x 460	240	240	26,67	14,77	12,34	12,34	14,77
11,3 x 500	260	260	31,28	15,21	12,34	12,34	15,21
11,3 x 540	280	280	33,89	15,21	12,34	12,34	15,21
11,3 x 580	300	300	36,49	15,21	12,34	12,34	15,21
11,3 x 620	320	320	39,10	15,21	12,34	12,34	15,21
11,3 x 660	340	340	41,71	15,21	12,34	12,34	15,21
11,3 x 700	360	360	44,32	15,21	12,34	12,34	15,21
11,3 x 750	380	380	48,23	15,21	12,34	12,34	15,21
11,3 x 800	400	420	50,00	15,21	12,34	15,21	12,34
11,3 x 900	460	460	50,00	15,21	12,34	12,34	15,21
11,3 x 1000	500	520	50,00	15,21	12,34	15,21	12,34

Calculation according to ETA-11/0024. Wood density  $\rho_k = 380 \text{ kg/m}^3$ . All mechanical values provided should be viewed as subject to the assumptions that have been made and represent example calculations.

All values are calculated minimum values and are subject to typographical and printing errors.

a) The characteristic values of the load-bearing capacity  $R_k$  cannot be treated as equivalent to the max. possible load (the max. force). Characteristic values of the load-bearing capacity  $R_k$  should be reduced to dimensioning values  $R_d$  with regard to the usage class and class of the load duration:  $R_d = R_k \cdot k_{mod} / \gamma_M$ . The dimensioning values of the load-bearing capacity  $R_d$  should be contrasted with the dimensioning values of the loads ( $R_d \geq E_d$ ).

### Example:

Characteristic value for constant load (dead weight)  $G_k = 2,00 \text{ kN}$  and variable load (e. g. snow load)  $Q_k = 3,00 \text{ kN}$ .  $k_{mod} = 0,9$ ,  $\gamma_M = 1,3$ .

→ Dimensioning value of the load  $E_d = 2,00 \cdot 1,35 + 3,00 \cdot 1,5 = 7,20 \text{ kN}$ .

The load-bearing capacity of the joint is therefore considered to have been demonstrated if  $R_d \geq E_d$  →  $\min R_k = R_d \cdot \gamma_M / k_{mod}$

i.e. the characteristic minimum value is calculated based on:  $\min R_k = R_d \cdot \gamma_M / k_{mod} \rightarrow R_k = 7,20 \text{ kN} \cdot 1,3 / 0,9 = 10,40 \text{ kN}$  → comparison with table values.

Please note: These are planning aids. Projects must only be calculated by authorised persons.

# KonstruX with countersunk head and drill point or AG tip

## 11,3 mm: timber/timber connection

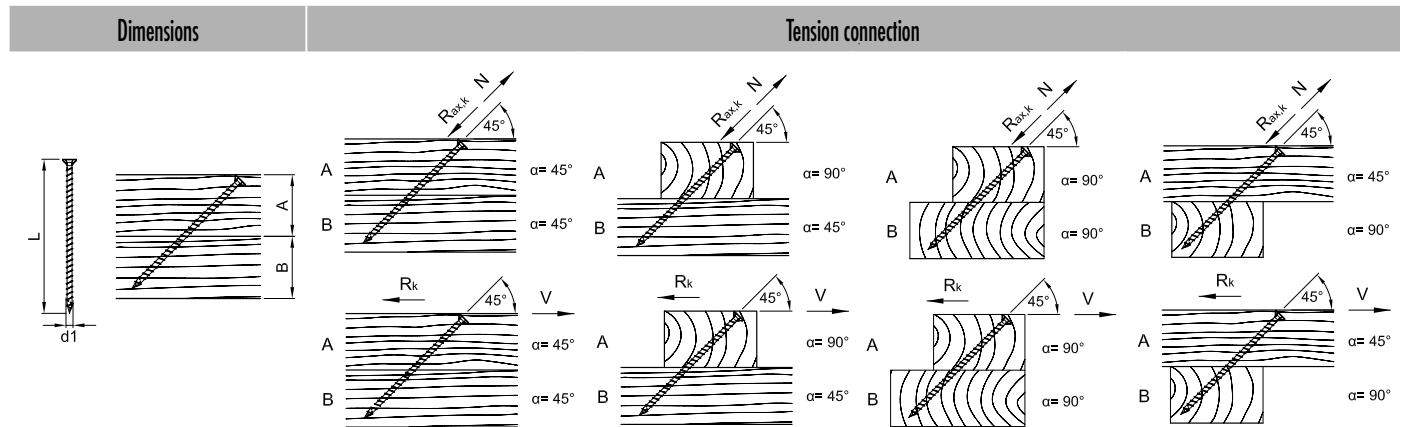

Characteristic value of the joint's load-bearing capacity  $R_{ox,k}$  or  $R_k$  acc. to ETA-11/0024

d1 x L [mm]	A [mm]	B [mm]	$R_{ox,k}^{a)}$ - [kN]	$R_k^{a)}$ - [kN]	$R_{ox,k}^{a)}$ - [kN]	$R_k^{a)}$ - [kN]	$R_{ox,k}^{a)}$ - [kN]	$R_k^{a)}$ - [kN]	$R_{ox,k}^{a)}$ - [kN]	$R_k^{a)}$ - [kN]
			$\alpha = 45^\circ$		$\alpha_A = 90^\circ$ $\alpha_B = 45^\circ$		$\alpha_A = 90^\circ$ $\alpha_B = 90^\circ$		$\alpha_A = 45^\circ$ $\alpha_B = 90^\circ$	
11,3 x 300	120	120	16,98	12,01	16,98	12,01	16,98	12,01	16,98	12,01
11,3 x 340	140	120	18,51	13,09	18,51	13,09	18,51	13,09	18,51	13,09
11,3 x 380	140	140	23,72	16,77	23,72	16,77	23,72	16,77	23,72	16,77
11,3 x 420	160	160	25,25	17,85	25,25	17,85	25,25	17,85	25,25	17,85
11,3 x 460	180	160	26,78	18,93	26,78	18,93	26,78	18,93	26,78	18,93
11,3 x 500	180	200	31,99	22,62	31,99	22,62	31,99	22,62	31,99	22,62
11,3 x 540	200	200	33,52	23,70	33,52	23,70	33,52	23,70	33,52	23,70
11,3 x 580	220	220	35,04	24,78	35,04	24,78	35,04	24,78	35,04	24,78
11,3 x 620	220	240	40,26	28,47	40,26	28,47	40,26	28,47	40,26	28,47
11,3 x 660	240	240	41,79	29,55	41,79	29,55	41,79	29,55	41,79	29,55
11,3 x 700	260	260	43,31	30,63	43,31	30,63	43,31	30,63	43,31	30,63
11,3 x 750	280	280	46,14	32,63	46,14	32,63	46,14	32,63	46,14	32,63
11,3 x 800	300	280	48,97	34,63	48,97	34,63	48,97	34,63	48,97	34,63
11,3 x 900	320	340	50,00	35,36	50,00	35,36	50,00	35,36	50,00	35,36
11,3 x 1000	360	360	50,00	35,36	50,00	35,36	50,00	35,36	50,00	35,36

Calculation according to ETA-11/0024. Wood density  $\rho_k = 380 \text{ kg/m}^3$ . All mechanical values provided should be viewed as subject to the assumptions that have been made and represent example calculations.

All values are calculated minimum values and are subject to typographical and printing errors.

a) The characteristic values of the load-bearing capacity  $R_k$  cannot be treated as equivalent to the max. possible load (the max. force). Characteristic values of the load-bearing capacity  $R_k$  should be reduced to dimensioning values  $R_d$  with regard to the usage class and class of the load duration:  $R_d = R_k \cdot k_{mod} / \gamma_M$ . The dimensioning values of the load-bearing capacity  $R_d$  should be contrasted with the dimensioning values of the loads ( $R_d \geq E_d$ ).

### Example:

Characteristic value for constant load (dead weight)  $G_k = 2,00 \text{ kN}$  and variable load (e. g. snow load)  $Q_k = 3,00 \text{ kN}$ .  $k_{mod} = 0,9$ .  $\gamma_M = 1,3$ .

→ Dimensioning value of the load  $E_d = 2,00 \cdot 1,35 + 3,00 \cdot 1,5 = 7,20 \text{ kN}$ .

The load-bearing capacity of the joint is therefore considered to have been demonstrated if  $R_d \geq E_d$ . →  $\min R_k = R_d \cdot \gamma_M / k_{mod}$

i.e. the characteristic minimum value is calculated based on:  $\min R_k = R_d \cdot \gamma_M / k_{mod} \rightarrow R_k = 7,20 \text{ kN} \cdot 1,3 / 0,9 = 10,40 \text{ kN}$  → comparison with table values.

Please note: These are planning aids. Projects must only be calculated by authorised persons.



# KonstruX ST with countersunk head and drill point 6,5 to 10,0 mm: steel/timber joints

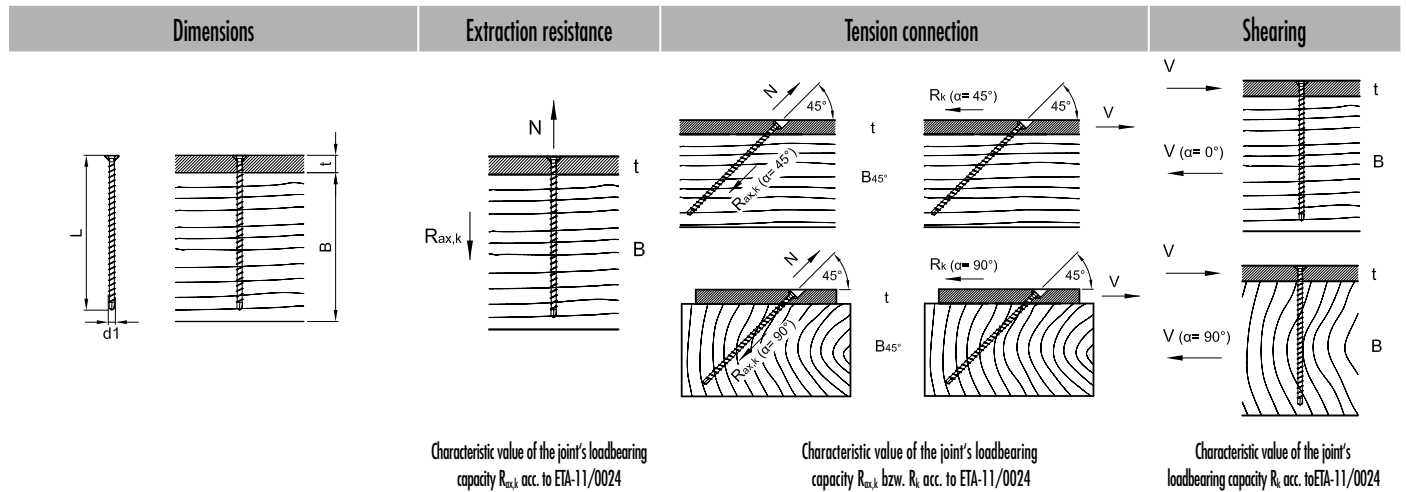

d1 x L [mm]	t [mm]	B [mm]	B <sub>45°</sub> [mm]	Characteristic value of the joint's loadbearing capacity $R_{ax,k}^{(a)}$ - [kN]		Characteristic value of the joint's loadbearing capacity $R_{ax,k}$ bzw. $R_k$ acc. to ETA-11/0024				Characteristic value of the joint's loadbearing capacity $R_k$ acc. to ETA-11/0024	
				$R_{ax,k}^{(a)}$ - [kN]	$R_{ax,k}^{(a)}$ - [kN]	$R_{ax,k}^{(a)}$ - [kN]	$R_k^{(a)}$ - [kN]	$R_k^{(a)}$ - [kN]	$R_k^{(a)}$ - [kN]	$R_k^{(a)}$ - [kN]	$R_k^{(a)}$ - [kN]
						$\alpha=45^\circ$	$\alpha=90^\circ$	$\alpha=45^\circ$	$\alpha=90^\circ$	$\alpha=0^\circ$	$\alpha=90^\circ$
6,5 x 80	15	80	60	5,14	4,65	4,65	3,29	3,29	4,17	3,52	
6,5 x 100	15	100	80	6,73	6,24	6,24	4,41	4,41	4,17	3,52	
6,5 x 120	15	120	80	8,31	7,82	7,82	5,53	5,53	4,17	3,52	
6,5 x 140	15	140	100	9,89	9,40	9,40	6,65	6,65	4,17	3,52	
8,0 x 95	15	100	80	7,59	7,00	7,00	4,95	4,95	6,18	5,22	
8,0 x 125	15	120	100	10,43	9,84	9,84	6,96	6,96	6,18	5,22	
8,0 x 155	15	160	120	13,28	12,69	12,69	8,97	8,97	6,18	5,22	
8,0 x 195	15	200	140	17,07	16,48	16,48	11,65	11,65	6,18	5,22	
8,0 x 220	15	220	160	19,44	18,85	18,85	13,33	13,33	6,18	5,22	
8,0 x 245	15	240	180	21,81	21,22	21,22	15,01	15,01	6,18	5,22	
8,0 x 270	15	280	200	24,18	23,59	23,59	16,68	16,68	6,18	5,22	
8,0 x 295	15	300	220	25,00	25,00	25,00	17,68	17,68	6,18	5,22	
8,0 x 330	15	340	240	25,00	25,00	25,00	17,68	17,68	6,18	5,22	
8,0 x 375	15	380	280	25,00	25,00	25,00	17,68	17,68	6,18	5,22	
8,0 x 400	15	400	280	25,00	25,00	25,00	17,68	17,68	6,18	5,22	
8,0 x 430	15	440	300	25,00	25,00	25,00	17,68	17,68	6,18	5,22	
8,0 x 480	15	480	340	25,00	25,00	25,00	17,68	17,68	6,18	5,22	
10,0 x 125	15	120	100	12,69	11,97	11,97	8,46	8,46	8,72	7,30	
10,0 x 155	15	160	120	16,15	15,43	15,43	10,91	10,91	8,72	7,30	
10,0 x 195	15	200	140	20,76	20,05	20,05	14,17	14,17	8,72	7,30	
10,0 x 220	15	220	160	23,65	22,93	22,93	16,21	16,21	8,72	7,30	
10,0 x 245	15	240	180	26,53	25,81	25,81	18,25	18,25	8,72	7,30	
10,0 x 270	15	280	200	29,41	28,70	28,70	20,29	20,29	8,72	7,30	
10,0 x 300	15	300	220	32,87	32,16	32,16	22,74	22,74	8,72	7,30	
10,0 x 330	15	340	240	33,00	33,00	33,00	23,33	23,33	8,72	7,30	
10,0 x 360	15	360	260	33,00	33,00	33,00	23,33	23,33	8,72	7,30	
10,0 x 400	15	400	280	33,00	33,00	33,00	23,33	23,33	8,72	7,30	
10,0 x 450	15	460	320	33,00	33,00	33,00	23,33	23,33	8,72	7,30	
10,0 x 500	15	500	360	33,00	33,00	33,00	23,33	23,33	8,72	7,30	
10,0 x 550	15	560	400	33,00	33,00	33,00	23,33	23,33	8,72	7,30	
10,0 x 600	15	600	420	33,00	33,00	33,00	23,33	23,33	8,72	7,30	

Calculation according to ETA-11/0024. Wood density  $\rho_k = 380 \text{ kg/m}^3$ . All mechanical values provided should be viewed as subject to the assumptions that have been made and represent example calculations.

All values are calculated minimum values and are subject to typographical and printing errors.

a) The characteristic values of the load-bearing capacity  $R_k$  cannot be treated as equivalent to the max. possible load (the max. force). Characteristic values of the load-bearing capacity  $R_k$  should be reduced to dimensioning values  $R_d$  with regard to the usage class and class of the load duration:  $R_d = R_k \cdot k_{mod} / \gamma_{Mk}$ . The dimensioning values of the load-bearing capacity  $R_d$  should be contrasted with the dimensioning values of the loads ( $R_d \geq E_d$ ).

### Example:

Characteristic value for constant load (dead weight)  $G_k = 2,00 \text{ kN}$  and variable load (e.g. snow load)  $Q_k = 3,00 \text{ kN}$ .  $k_{mod} = 0,9$ ,  $\gamma_{Mk} = 1,3$ .  $\rightarrow$  Dimensioning value of the load  $E_d = 2,00 \cdot 1,35 + 3,00 \cdot 1,5 = 7,20 \text{ kN}$ . The load-bearing capacity of the joint is therefore considered to have been demonstrated if  $R_d \geq E_d$ .  $\rightarrow \min R_k = R_d \cdot \gamma_{Mk} / k_{mod}$ . i.e. the characteristic minimum value is calculated based on:  $\min R_k = R_d \cdot \gamma_{Mk} / k_{mod} \rightarrow R_k = 7,20 \text{ kN} \cdot 1,3 / 0,9 = 10,40 \text{ kN}$   $\rightarrow$  comparison with table values.

Please note: These are planning aids. Projects must only be calculated by authorised persons.

# KonstruX with countersunk head and drill point or AG tip

## 11,3 mm: steel/timber connection

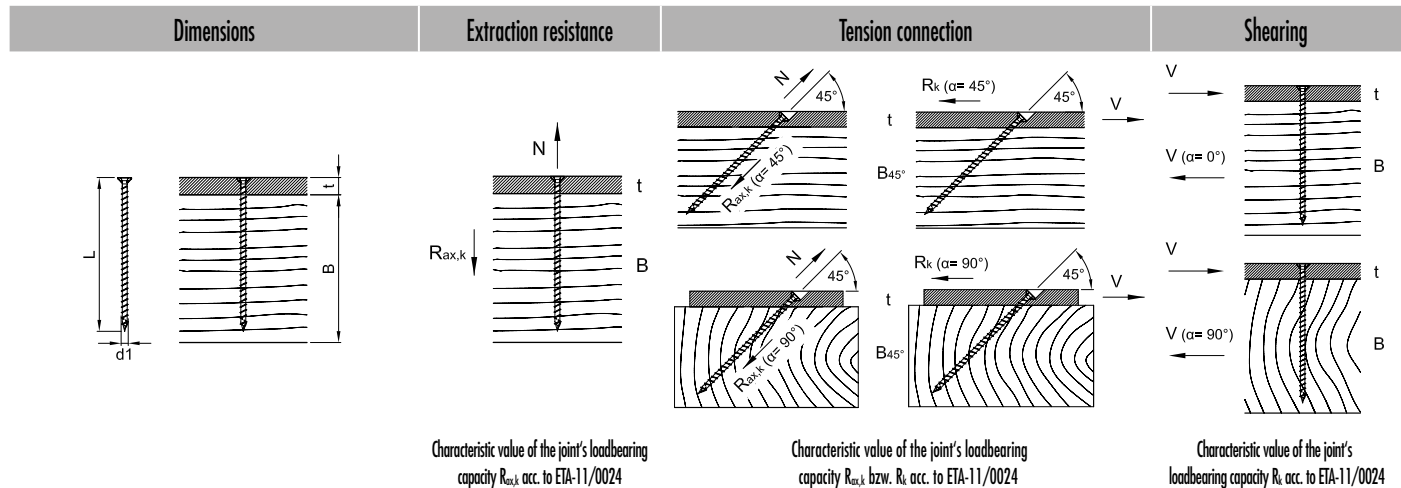

d1 x L [mm]	t [mm]	B [mm]	B <sub>45°</sub> [mm]	$R_{ax,k}^{a)}$ - [kN]	$R_{ax,k}^{a)}$ - [kN]		$R_k^{a)}$ - [kN]		$R_k^{a)}$ - [kN]	
					$\alpha=45^\circ$	$\alpha=90^\circ$	$\alpha=45^\circ$	$\alpha=90^\circ$	$\alpha=0^\circ$	$\alpha=90^\circ$
11,3 x 300	20	300	220	36,49	35,42	35,42	25,04	25,04	11,79	9,76
11,3 x 340	20	340	240	41,71	40,63	40,63	28,73	28,73	11,79	9,76
11,3 x 380	20	380	260	46,92	45,84	45,84	32,42	32,42	11,79	9,76
11,3 x 420	20	420	300	50,00	50,00	50,00	35,36	35,36	11,79	9,76
11,3 x 460	20	460	320	50,00	50,00	50,00	35,36	35,36	11,79	9,76
11,3 x 500	20	500	360	50,00	50,00	50,00	35,36	35,36	11,79	9,76
11,3 x 540	20	540	380	50,00	50,00	50,00	35,36	35,36	11,79	9,76
11,3 x 580	20	580	420	50,00	50,00	50,00	35,36	35,36	11,79	9,76
11,3 x 620	20	620	440	50,00	50,00	50,00	35,36	35,36	11,79	9,76
11,3 x 660	20	660	460	50,00	50,00	50,00	35,36	35,36	11,79	9,76
11,3 x 700	20	700	500	50,00	50,00	50,00	35,36	35,36	11,79	9,76
11,3 x 750	20	740	540	50,00	50,00	50,00	35,36	35,36	11,79	9,76
11,3 x 800	20	800	560	50,00	50,00	50,00	35,36	35,36	11,79	9,76
11,3 x 900	20	900	640	50,00	50,00	50,00	35,36	35,36	11,79	9,76
11,3 x 1000	20	1000	700	50,00	50,00	50,00	35,36	35,36	11,79	9,76

Calculation according to ETA-11/0024. Wood density  $\rho_k = 380 \text{ kg/m}^3$ . All mechanical values provided should be viewed as subject to the assumptions that have been made and represent example calculations.

All values are calculated minimum values and are subject to typographical and printing errors.

a) The characteristic values of the load-bearing capacity  $R_k$  cannot be treated as equivalent to the max. possible load (the max. force). Characteristic values of the load-bearing capacity  $R_k$  should be reduced to dimensioning values  $R_d$  with regard to the usage class and class of the load duration:  $R_d = R_k \cdot k_{mod} / \gamma_M$ . The dimensioning values of the load-bearing capacity  $R_d$  should be contrasted with the dimensioning values of the loads ( $R_d \geq E_d$ ).

### Example:

Characteristic value for constant load (dead weight)  $G_k = 2,00 \text{ kN}$  and variable load (e. g. snow load)  $Q_k = 3,00 \text{ kN}$ .  $k_{mod} = 0,9$ ,  $\gamma_M = 1,3$ .

→ Dimensioning value of the load  $E_d = 2,00 \cdot 1,35 + 3,00 \cdot 1,5 = 7,20 \text{ kN}$ .

The load-bearing capacity of the joint is therefore considered to have been demonstrated if  $R_d \geq E_d$ . →  $\min R_k = R_d \cdot \gamma_M / k_{mod}$

i.e. the characteristic minimum value is calculated based on:  $\min R_k = R_d \cdot \gamma_M / k_{mod} \rightarrow R_k = 7,20 \text{ kN} \cdot 1,3 / 0,9 = 10,40 \text{ kN}$  → comparison with table values.

Please note: These are planning aids. Projects must only be calculated by authorised persons.

# KonstruX ST with cylinder head and drill point

## 6,5 mm: main/secondary beam joints

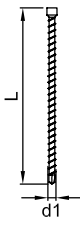
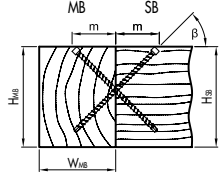
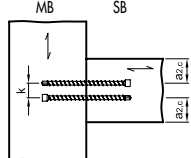
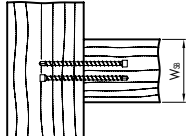
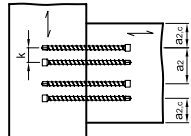
Dimensions		Main / secondary beam connection						
								
								
		$a_2 = \text{min. } 33 \text{ mm}, a_{2,c} = \text{min. } 20 \text{ mm}, k = \text{min. } 10 \text{ mm}$						
		Characteristic value of the joint's loadbearing capacity $R_k$ acc. to ETA-11/0024						
$d1 \times L$ [mm]	min. $W_{MB}$ [mm]	min. $H_{SB}$ [mm]	min. $W_{MB}$ [mm]	min. $H_{MB}$ [mm]	$m$ [mm]	$\beta$ °	$R_{v,k}^{a) b)}$ - [kN]	Pair (n)
6,5 x 195	60						10,91	1
	100						20,36	2
	120	160	80	160	69	45	29,33	3
	160						38,00	4

Calculation according to ETA-11/0024. Wood density  $\rho_k = 380 \text{ kg/m}^3$ . All mechanical values provided should be viewed as subject to the assumptions that have been made and represent example calculations. All values are calculated minimum values and are subject to typographical and printing errors.

a) The characteristic values of the load-bearing capacity  $R_k$  cannot be treated as equivalent to the max. possible load (the max. force). Characteristic values of the load-bearing capacity  $R_k$  should be reduced to dimensioning values  $R_d$  with regard to the usage class and class of the load duration:  $R_d = R_k \cdot k_{mod} / \gamma_M$ . The dimensioning values of the load-bearing capacity  $R_d$  should be contrasted with the dimensioning values of the loads ( $R_d \geq E_d$ ).

### Example:

Characteristic value for constant load (dead weight)  $G_k = 2,00 \text{ kN}$  and variable load (e. g. snow load)  $Q_k = 3,00 \text{ kN}$ .  $k_{mod} = 0,9$ .  $\gamma_M = 1,3$ .  
 → Dimensioning value of the load  $E_d = 2,00 \cdot 1,35 + 3,00 \cdot 1,5 = 7,20 \text{ kN}$ .

The load-bearing capacity of the joint is therefore considered to have been demonstrated if  $R_d \geq E_d$ . →  $\text{min } R_k = R_d \cdot \gamma_M / k_{mod}$

i.e. the characteristic minimum value is calculated based on:  $\text{min } R_k = R_d \cdot \gamma_M / k_{mod} \rightarrow R_k = 7,20 \text{ kN} \cdot 1,3 / 0,9 = 10,40 \text{ kN}$  → comparison with table values.

b) estimated with an efficient quantity of pairs of screws:  $n^{0,9}$ .

Please note: These are planning aids. Projects must only be calculated by authorised persons.

# KonstruX ST with cylinder head and drill point 8,0 mm: main/secondary beam joints

**Dimensions** | **Main / secondary beam connection**

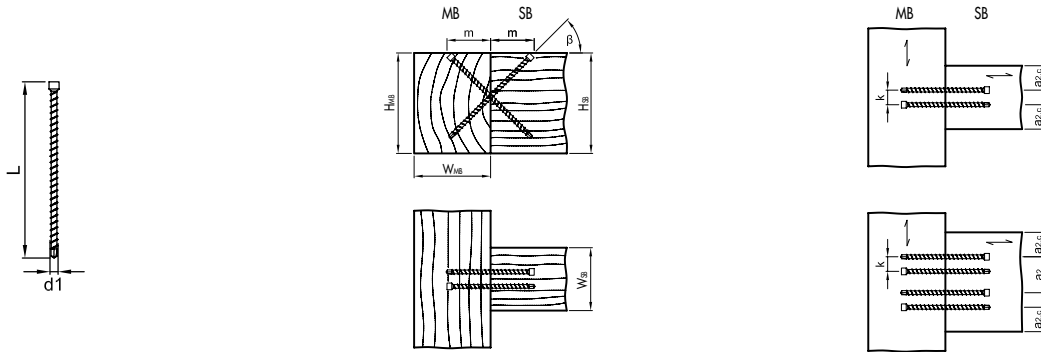

$a_2 = \text{min. } 40 \text{ mm}, a_{2c} = \text{min. } 24 \text{ mm}, k = \text{min. } 12 \text{ mm}$

Characteristic value of the joint's loadbearing capacity  $R_k$ , acc. to ETA-11/0024

$d1 \times L$ [mm]	min. $W_{SB}$ [mm]	min. $H_{SB}$ [mm]	min. $W_{MB}$ [mm]	min. $H_{MB}$ [mm]	$m$ [mm]	$\beta$ °	$R_{yk}^{a) b)}$ - [kN]	Pair (n)
8,0 x 245	80	200	100	200	87	45	16,43	1
	100						30,66	2
	140						44,16	3
	180						57,21	4
8,0 x 295	80	220	120	220	104	45	17,44	1
	100						32,55	2
	140						46,88	3
	180						60,74	4
8,0 x 330	80	260	140	260	117	45	17,44	1
	100						32,55	2
	140						46,88	3
	180						60,74	4
8,0 x 375	80	280	160	280	133	45	17,44	1
	100						32,55	2
	140						46,88	3
	180						60,74	4
8,0 x 400	80	300	160	300	141	45	17,44	1
	100						32,55	2
	140						46,88	3
	180						60,74	4
8,0 x 430	80	320	180	320	152	45	17,44	1
	100						32,55	2
	140						46,88	3
	180						60,74	4
8,0 x 480	80	360	180	360	170	45	17,44	1
	100						32,55	2
	140						46,88	3
	180						60,74	4

Calculation according to ETA-11/0024. Wood density  $\rho_{15} = 380 \text{ kg/m}^3$ . All mechanical values provided should be viewed as subject to the assumptions that have been made and represent example calculations.

All values are calculated minimum values and are subject to typographical and printing errors.

a) The characteristic values of the load-bearing capacity  $R_k$  cannot be treated as equivalent to the max. possible load (the max. force). Characteristic values of the load-bearing capacity  $R_k$  should be reduced to dimensioning values  $R_d$  with regard to the usage class and class of the load duration:  $R_d = R_k \cdot k_{mod} / \gamma_M$ . The dimensioning values of the load-bearing capacity  $R_d$  should be contrasted with the dimensioning values of the loads ( $R_d \geq E_d$ ).

**Example:**

Characteristic value for constant load (dead weight)  $G_k = 2,00 \text{ kN}$  and variable load (e. g. snow load)  $Q_k = 3,00 \text{ kN}$ .  $k_{mod} = 0,9$ ,  $\gamma_M = 1,3$ .

→ Dimensioning value of the load  $E_d = 2,00 \cdot 1,35 + 3,00 \cdot 1,5 = 7,20 \text{ kN}$ .

The load-bearing capacity of the joint is therefore considered to have been demonstrated if  $R_d \geq E_d$ . →  $\text{min } R_k = R_d \cdot \gamma_M / k_{mod}$

i.e. the characteristic minimum value is calculated based on:  $\text{min } R_k = R_d \cdot \gamma_M / k_{mod} \rightarrow R_k = 7,20 \text{ kN} \cdot 1,3 / 0,9 = 10,40 \text{ kN}$  → comparison with table values.

b) estimated with an efficient quantity of pairs of screws:  $n^{0,9}$ .

Please note: These are planning aids. Projects must only be calculated by authorised persons.



# KonstruX ST with cylinder head and drill point

## 10,0 mm: main/secondary beam joints

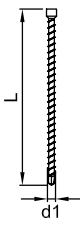
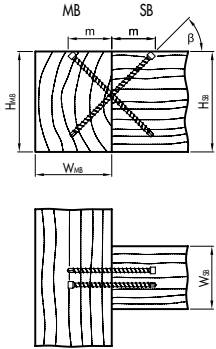
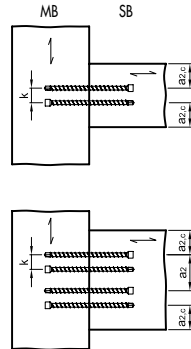
Dimensions		Main / secondary beam connection						
								
		$a_1 = \text{min. } 50 \text{ mm}, a_2 = \text{min. } 30 \text{ mm}, k = \text{min. } 15 \text{ mm}$					Characteristic value of the joint's loadbearing capacity $R_k$ acc. to ETA-11/0024	
$d1 \times L$ [mm]	min. $W_{MB}$ [mm]	min. $H_{SB}$ [mm]	min. $W_{MB}$ [mm]	min. $H_{MB}$ [mm]	$m$ [mm]	$\beta$ °	$R_{v,k}^{a) b)}$ - [kN]	Pair (n)
10,0 x 300	80	240	120	240	106	45	23,67	1
	140						44,18	2
	180						63,63	3
	240						82,44	4
10,0 x 330	80	260	140	260	117	45	23,67	1
	140						44,18	2
	180						63,63	3
	240						82,44	4
10,0 x 360	80	280	140	280	127	45	23,67	1
	140						44,18	2
	180						63,63	3
	240						82,44	4
10,0 x 400	80	300	160	300	141	45	23,67	1
	140						44,18	2
	180						63,63	3
	240						82,44	4
10,0 x 450	80	340	180	340	159	45	23,67	1
	140						44,18	2
	180						63,63	3
	240						82,44	4
10,0 x 500	80	380	200	380	177	45	23,67	1
	140						44,18	2
	180						63,63	3
	240						82,44	4
10,0 x 550	80	400	220	400	194	45	23,67	1
	140						44,18	2
	180						63,63	3
	240						82,44	4
10,0 x 600	80	440	240	440	212	45	23,67	1
	140						44,18	2
	180						63,63	3
	240						82,44	4

Calculation according to ETA-11/0024. Wood density  $\rho_k = 380 \text{ kg/m}^3$ . All mechanical values provided should be viewed as subject to the assumptions that have been made and represent example calculations.

All values are calculated minimum values and are subject to typographical and printing errors.

a) The characteristic values of the load-bearing capacity  $R_k$  cannot be treated as equivalent to the max. possible load (the max. force). Characteristic values of the load-bearing capacity  $R_k$  should be reduced to dimensioning values  $R_d$  with regard to the usage class and class of the load duration:  $R_d = R_k \cdot k_{mod} / \gamma_M$ . The dimensioning values of the load-bearing capacity  $R_d$  should be contrasted with the dimensioning values of the loads ( $R_d \geq E_d$ ).

### Example:

Characteristic value for constant load (dead weight)  $G_k = 2,00 \text{ kN}$  and variable load (e. g. snow load)  $Q_k = 3,00 \text{ kN}$ .  $k_{mod} = 0,9$ .  $\gamma_M = 1,3$ .

→ Dimensioning value of the load  $E_d = 2,00 \cdot 1,35 + 3,00 \cdot 1,5 = 7,20 \text{ kN}$ .

The load-bearing capacity of the joint is therefore considered to have been demonstrated if  $R_d \geq E_d \rightarrow \text{min } R_d = R_k \cdot \gamma_M / k_{mod}$

i.e. the characteristic minimum value is calculated based on:  $\text{min } R_k = R_d \cdot \gamma_M / k_{mod} \rightarrow R_k = 7,20 \text{ kN} \cdot 1,3 / 0,9 = 10,40 \text{ kN} \rightarrow$  comparison with table values.

b) estimated with an efficient quantity of pairs of screws:  $n^{0,9}$ .

Please note: These are planning aids. Projects must only be calculated by authorised persons.

# Timber frame construction with KonstruX ST

Connections with fully threaded screws



© dynamiltd.com - stock.adobe.com

The KonstruX ST is a universal fully threaded screw for connecting timber frame elements such as posts and cross-beams. Measuring 6 mm in diameter, the KonstruX ST ZK is especially suitable for connecting slim timber frame elements grouped in service classes 1 and 2.

Due to the special drill tip geometry, reduced edge and centre distances may be used. This enables use in smaller cross-sections. The reduced drill tip has no negative impact on the extraction resistance of the screw thread. The fine double thread behind the drill tip reduces the screw-in torque.

Fully threaded screws are optimally used when they are loaded axially, i.e. in tension (or compression). Full-thread screws cannot reach their full potential if they are used for shearing only. Therefore, always try to position the screws in the direction of the force applied. If the force-axis angle (not to be confused with the axis-fibre angle) is between 0° and 45°, the bolts may be considered as purely tensioned. Proof of shearing is therefore not required. The connection is therefore much more stable with an inclined screw connection than with a screw connection at 90° to the force. KonstruX ST may be set independently of the fibre direction, i.e. also parallel to the fibre. The pull-out resistance remains between 45° and 90° mathematically equal.

## Matching screw

KonstruX ST: ZK, Ø 6,5 mm  
 Assembly pliers: 80 – 195 mm  
 Sinkable cylinder head  
 Material: Steel hardened  
 Surface coating: Electrogalvanised



## Sample applications

There are many application options for fully threaded screws. Cylinder head screws are designed for connecting wood/wood components. The cylinder heads can be sunk deep into the wood with an adequate long bit. In visible beam constructions, the connecting elements are therefore not virtually invisible. In contrast to partially-threaded screws, with fully threaded screws it is also irrelevant in which component the head is located, except of course steel/wood connections. In any case, the required minimum edge and centre distances must be observed.



Fastening cross-beams in lightweight timber frame constructions



Fastening supports in timber frame constructions



Fastening supports in timber frame constructions and main / secondary beam connections



Fastening supports in timber frame constructions in the inferior purlin area

### Sample applications

Timber-timber tensile loading

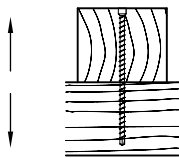

Timber-timber shearing

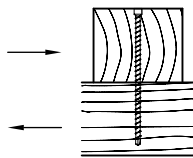

Timber-timber under tension at 45°

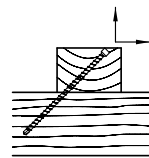

Timber-timber under tension at 45°

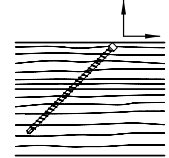

Main-secondary beam connection

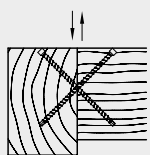

Post-crosspiece connection

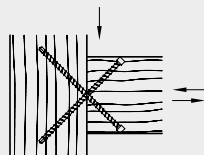

Support reinforcement

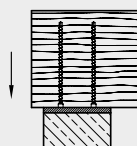

Support reinforcement

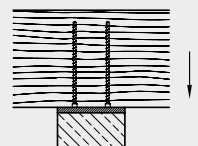

Transverse-shear reinforcement at notch

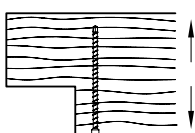

Transverse-shear reinforcement at hole

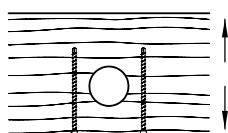

Joist doubling

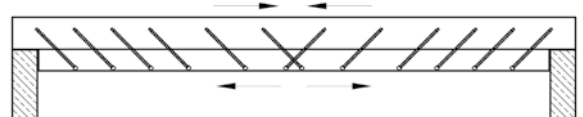

## KonstruX ST with cylinder head 6,5 mm

## Geometry and mechanical properties

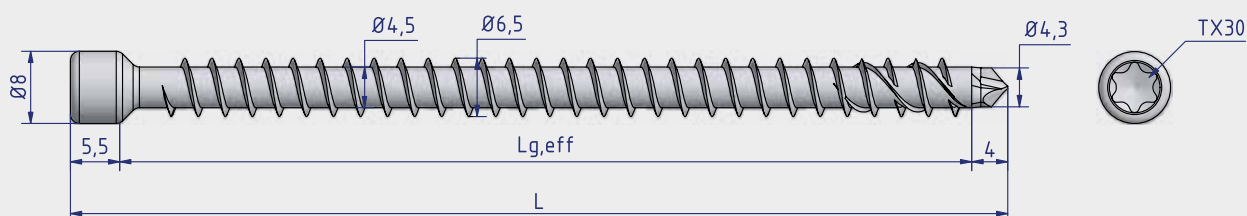

KonstruX ST-ZK Ø6,5xL -TX30

Art.no.	L [mm]	L <sub>g,eff</sub> [mm]	PU	Pre-drilling diameter Ød <sub>v</sub> [mm]	Characteristic pull-out resistance value f <sub>ax,k</sub> [N/mm <sup>2</sup> ]	Characteristic tensile strength value f <sub>tens,k</sub> [kN]	Characteristic yield moment M <sub>y,k</sub> [Nmm]	Characteristic yield strength f <sub>y,k</sub> [N/mm <sup>2</sup> ]
904808	80	71	100	4,5	11,4	17,0	15000	1000
904809	100	91	100	4,5	11,4	17,0	15000	1000
904810	120	111	100	4,5	11,4	17,0	15000	1000
904811	140	131	100	4,5	11,4	17,0	15000	1000
904812	160	151	100	4,5	11,4	17,0	15000	1000
904813	195	186	100	4,5	11,4	17,0	15000	1000



**Axial and edge distances**

The minimum distances for KonstruX loaded exclusively in the axial direction in pre-drilled and non-pre-drilled holes in components measuring min.  $t = 65$  thick and min. 60 mm wide must be selected as follows

Axial distance parallel to the direction of the grain	$a_1$	[mm]	$5 \cdot d$	33
Axial distance perpendicular to the direction of the grain	$a_2$	[mm]	$5 \cdot d$	33
Distance from the centre of gravity of the screw area driven into the wood from the end grain surface	$a_{1,c}$	[mm]	$5 \cdot d$	33
Distance from the centre of gravity of the screw area driven into the wood from the side grain surface	$a_{2,c}$	[mm]	$3 \cdot d$	20
Axial distance between a crossing pair of screws	$a_{2,k}$	[mm]	$1,5 \cdot d$	10
Reduced axial distance $a_2$ perpendicular to the direction of the grain, if $a_1 \cdot a_2 \geq 25 \cdot d^2$	$a_{2,red}$	[mm]	$2,5 \cdot d$	16

The axial and edge distances are minimum distances according to DIN EN 1995:2014 (EC5) and generally apply to fasteners subjected to transverse loads

$a_1$  Distance from the fasteners within a row in the direction of the grain

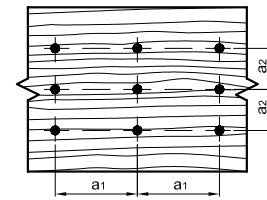

$a_2$  Distance from the fasteners perpendicular to the direction of the grain

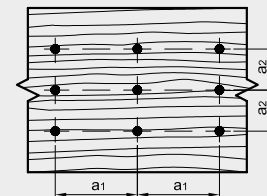

$a_{3,c}$  Distance between the fastener and the unloaded end of the end grain  $90^\circ \leq \alpha \leq 270^\circ$

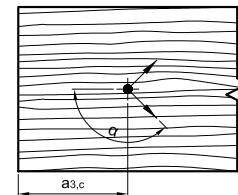

$a_{3,t}$  Distance between the fastener and the loaded end of the end grain  $-90^\circ \leq \alpha \leq 90^\circ$

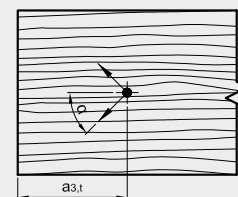

$a_{4,c}$  Distance between the fastener and the unloaded edge  $180^\circ \leq \alpha \leq 360^\circ$

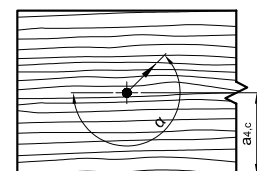

$a_{4,t}$  Distance between the fastener and the loaded edge  $0^\circ \leq \alpha \leq 180^\circ$

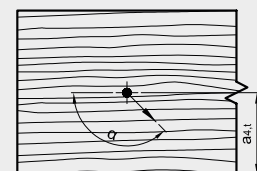

When analysed, the minimum distances for KonstruX screws in pre-drilled holes that are loaded in a crosswise direction are as follows according to the position of the direction of the grain

Minimum distances for KonstruX screws in pre-drilled holes that are loaded in a crosswise direction with a force / fibre angle of 0° and 90°

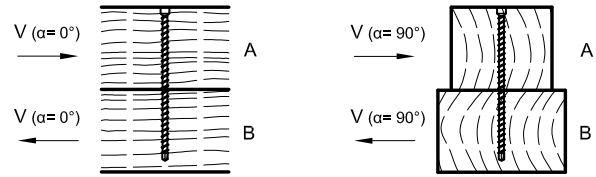

		[mm]	Force / fibre angle $\alpha = 0^\circ$		Force / fibre angle $\alpha = 90^\circ$	
Axial distance parallel to the direction of the grain	$a_1$	[mm]	5 · d	33	4 · d	33
Axial distance perpendicular to the direction of the grain	$a_2$	[mm]	3 · d	20	4 · d	33
Distance from the centre of gravity of the screw area driven into the wood from the unloaded end of the end grain	$a_{3c}$	[mm]	7 · d	46	7 · d	46
Distance from the centre of gravity of the screw area driven into the wood from the loaded end of the end grain	$a_{3l}$	[mm]	12 · d	78	7 · d	46
Axial distance perpendicular to the unloaded edge	$a_{4c}$	[mm]	3 · d	20	3 · d	20
Axial distance from the loaded edge	$a_{4l}$	[mm]	3 · d	20	7 · d	46

When analysed, the minimum distances for KonstruX in non-pre-drilled holes, loaded in a crosswise direction, are as follows according to the position of the direction of the grain

Minimum distances for KonstruX screws in non-pre-drilled holes that are loaded in a crosswise direction with a force / fibre angle of 0° and 90°

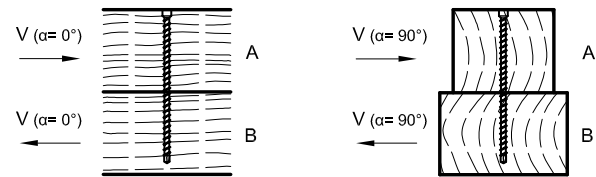

		[mm]	Force / fibre angle $\alpha = 0^\circ$		Force / fibre angle $\alpha = 90^\circ$	
Axial distance parallel to the direction of the grain	$a_1$	[mm]	12 · d	78	5 · d	33
Axial distance perpendicular to the direction of the grain	$a_2$	[mm]	5 · d	33	5 · d	33
Distance from the centre of gravity of the screw area driven into the wood from the unloaded end of the end grain	$a_{3c}$	[mm]	10 · d	65	10 · d	65
Distance from the centre of gravity of the screw area driven into the wood from the loaded end of the end grain	$a_{3l}$	[mm]	15 · d	98	10 · d	65
Axial distance perpendicular to the unloaded edge	$a_{4c}$	[mm]	5 · d	33	5 · d	33
Axial distance from the loaded edge	$a_{4l}$	[mm]	5 · d	33	10 · d	65

# KonstruX ST with cylinder head and drill point 6,5 mm: Shearing strength ratio without pre-drilling

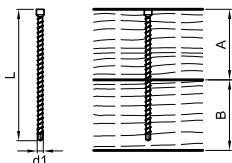
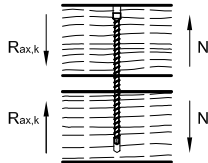
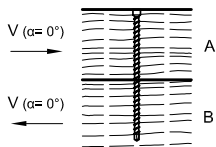
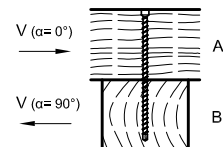
Dimensions			Axial pull-out load capacity	Shearing strength ratio without pre-drilling				
								
			<p>Characteristic value of the joint's loadbearing capacity <math>R_{ax,k}</math> to ETA-11/0024</p>	<p>Characteristic value of the joint's loadbearing capacity <math>R_k</math> to ETA-11/0024</p>				
$\text{Ød1} \times L$ [mm]	A [mm]	B [mm]	$R_{ax,k}^{a)}$ - [kN]	$R_k^{a)}$ - [kN]	$R_k^{a)}$ - [kN]	$R_k^{a)}$ - [kN]	$R_k^{a)}$ - [kN]	
				$\alpha = 0^\circ$	$\alpha = 90^\circ$	$\alpha_A = 0^\circ$	$\alpha_A = 90^\circ$	
						$\alpha_B = 90^\circ$	$\alpha_B = 0^\circ$	
6,5 x 120	60	80	4,35	3,83	3,37	3,83	3,37	
6,5 x 140	80	80	4,43	3,85	3,39	3,39	3,85	
6,5 x 160	80	100	5,94	4,22	3,76	4,22	3,76	
6,5 x 195	100	100	7,20	4,54	4,08	4,08	4,54	

Calculation according to ETA-11/0024. Wood density  $\rho_k = 380 \text{ kg/m}^3$ . All mechanical values provided should be viewed as subject to the assumptions that have been made and represent example calculations.

All values are calculated minimum values and are subject to typographical and printing errors.

a) The characteristic values of the load-bearing capacity  $R_k$  cannot be treated as equivalent to the max. possible load (the max. force). Characteristic values of the load-bearing capacity  $R_k$  should be reduced to dimensioning values  $R_d$  with regard to the usage class and class of the load duration:  $R_d = R_k \cdot k_{mod} / \gamma_{Mk}$ . The dimensioning values of the load-bearing capacity  $R_d$  should be contrasted with the dimensioning values of the loads ( $R_d \geq E_d$ ).

# KonstruX ST with cylinder head and drill point 6,5 mm: Axial pull-out load capacity without pre-drilling

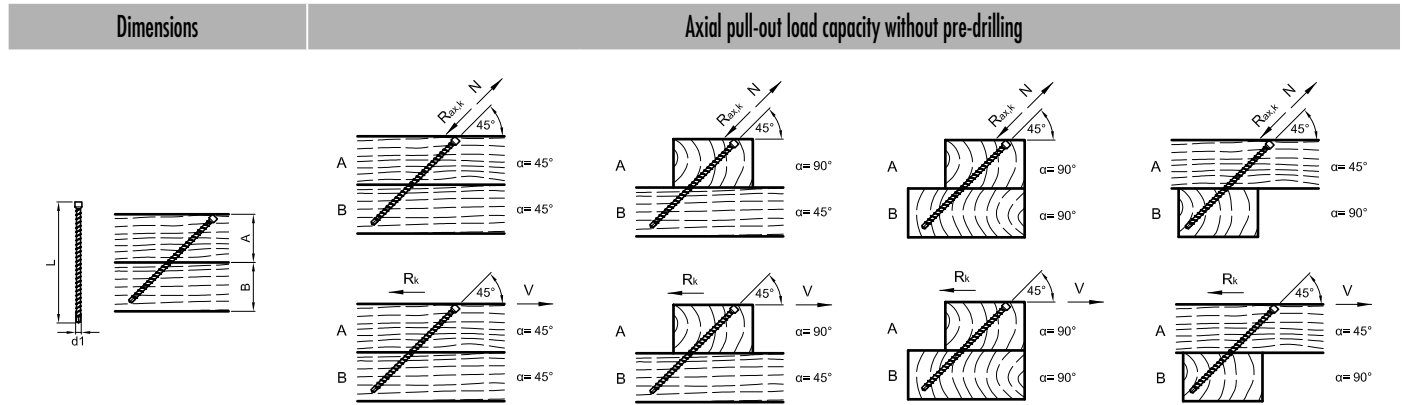

Characteristic value of the joint's loadbearing capacity  $R_{ax,k}$  to ETA-11/0024

$\varnothing d1 \times L$ [mm]	A [mm]	B [mm]	$R_{ax,k}^{a)}$ - [kN]	$R_k^{a)}$ - [kN]	$R_{ax,k}^{a)}$ - [kN]	$R_k^{a)}$ - [kN]	$R_{ax,k}^{a)}$ - [kN]	$R_k^{a)}$ - [kN]	$R_{ax,k}^{a)}$ - [kN]	$R_k^{a)}$ - [kN]
			$\alpha = 45^\circ$		$\alpha_A = 90^\circ$ $\alpha_B = 45^\circ$		$\alpha_A = 90^\circ$ $\alpha_B = 90^\circ$		$\alpha_A = 45^\circ$ $\alpha_B = 90^\circ$	
6,5 x 160	60	80	5,51	3,90	5,51	3,90	5,51	3,90	5,51	3,90
6,5 x 195	80	80	6,04	4,27	6,04	4,27	6,04	4,27	6,04	4,27

Calculation according to ETA-11/0024. Wood density  $\rho_k = 380 \text{ kg/m}^3$ . All mechanical values provided should be viewed as subject to the assumptions that have been made and represent example calculations.

All values are calculated minimum values and are subject to typographical and printing errors.

a) The characteristic values of the load-bearing capacity  $R_k$  cannot be treated as equivalent to the max. possible load (the max. force). Characteristic values of the load-bearing capacity  $R_k$  should be reduced to dimensioning values  $R_d$  with regard to the usage class and class of the load duration:  $R_d = R_k \cdot k_{mod} / \gamma_M$ . The dimensioning values of the load-bearing capacity  $R_d$  should be contrasted with the dimensioning values of the loads ( $R_d \geq E_d$ ).



# KonstruX ST with cylinder head and drill point

## 6,5 mm: main/secondary beam joints

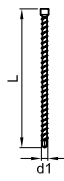
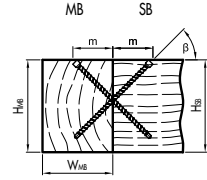
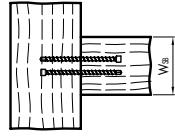
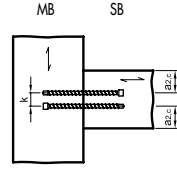
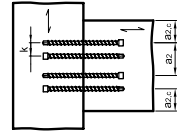
Dimensions		Main / secondary beam connection							
									
		$a_2 = \text{min. } 33 \text{ mm}, a_{2,c} = \text{min. } 20 \text{ mm}, k = \text{min. } 10 \text{ mm}$							Characteristic value of the joint's loadbearing capacity $R_{v,k}$ to ETA-11/0024
$d1 \times L$ [mm]	min. $W_{MB}$ [mm]	min. $H_{SB}$ [mm]	min. $W_{MB}$ [mm]	min. $H_{MB}$ [mm]	$m$ [mm]	$\beta$ °	$R_{v,k}^{a) b)}$ - [kN]	Pair (n)	
6,5 x 195	60						10,91	1	
	100						20,36	2	
	120	160	80	160	69	45	29,33	3	
	160						38,00	4	

Calculation according to ETA-11/0024. Wood density  $\rho_k = 380 \text{ kg/m}^3$ . All mechanical values provided should be viewed as subject to the assumptions that have been made and represent example calculations. All values are calculated minimum values and are subject to typographical and printing errors.

a) The characteristic values of the load-bearing capacity  $R_k$  cannot be treated as equivalent to the max. possible load (the max. force). Characteristic values of the load-bearing capacity  $R_k$  should be reduced to dimensioning values  $R_d$  with regard to the usage class and class of the load duration:  $R_d = R_k \cdot k_{mod} / \gamma_M$ . The dimensioning values of the load-bearing capacity  $R_d$  should be contrasted with the dimensioning values of the loads ( $R_d \geq E_d$ ).

# Wood-concrete composite system

Strengthening of ceiling frameworks in new builds and renovations



## What can it be used for?

- Is used both in new builds and in the renovation of residential and commercial buildings
- Combining wood and reinforced concrete

## Advantages

- Increased load-bearing capacity
- Increased rigidity
- Improved sound insulation
- Increased fire resistance
- The existing joists are retained
- The boarding can be retained (Topfloor system)



© by studio - stock.adobe.com



## Wood-concrete composite

Composite screw

Art. no.	Dimensions [mm]	PU
981841	7,3 x 150	200

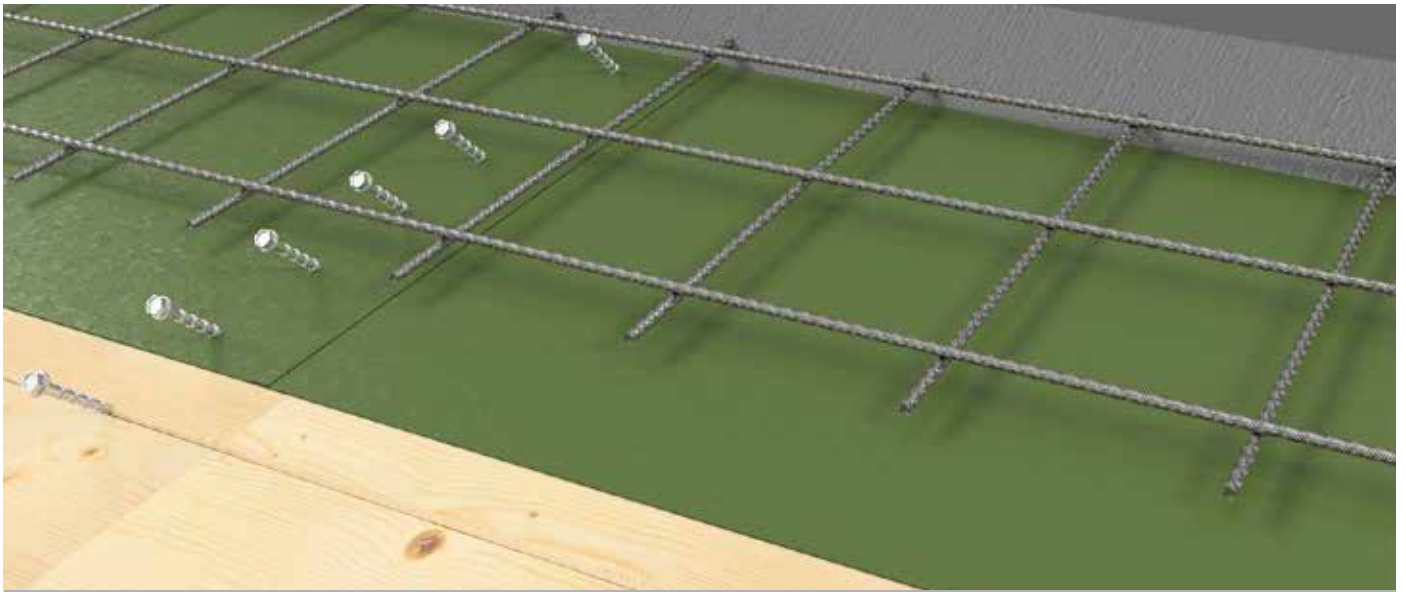

Topfloor (concrete on the top side)



### Intelligent load conversion

The ceiling load is resolved into compression components between the concrete and timber and tension components in the special screw.

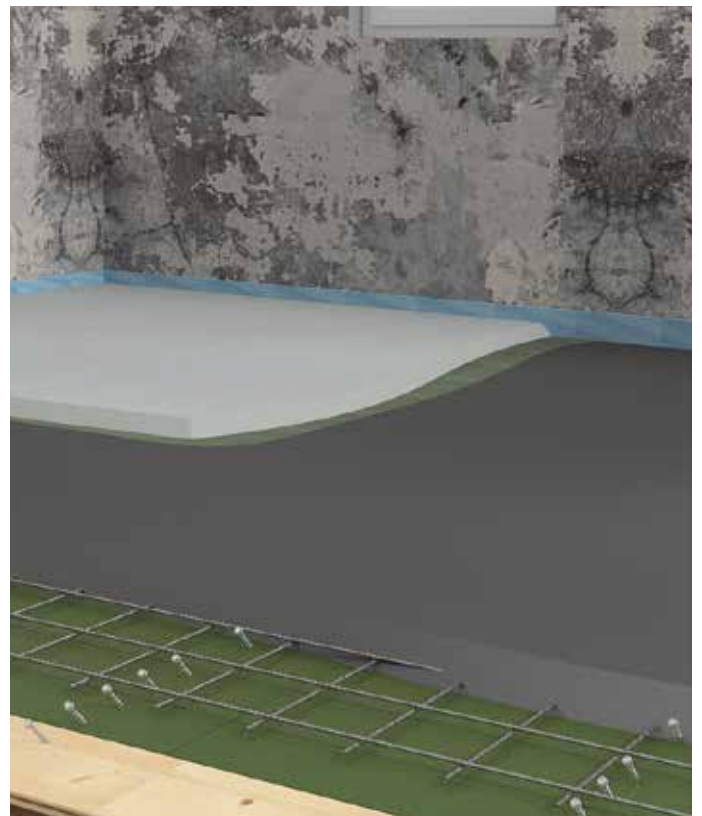

### Construction in the existing structure

Props lift the sag of the existing ceiling joists.



# Calculation aid

Projects for the wood-concrete composite system are precalculated by Eurotec. A customised software program based on Mathcad is available for this.

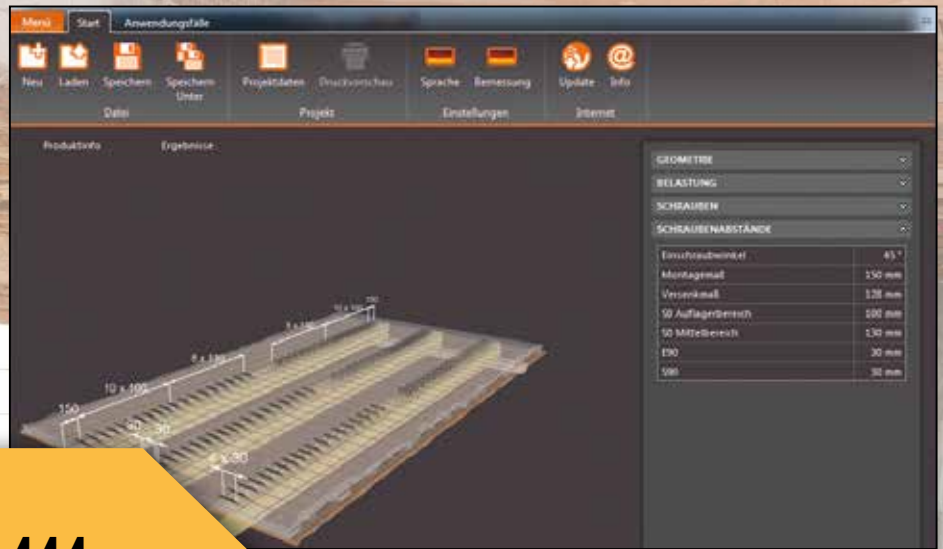
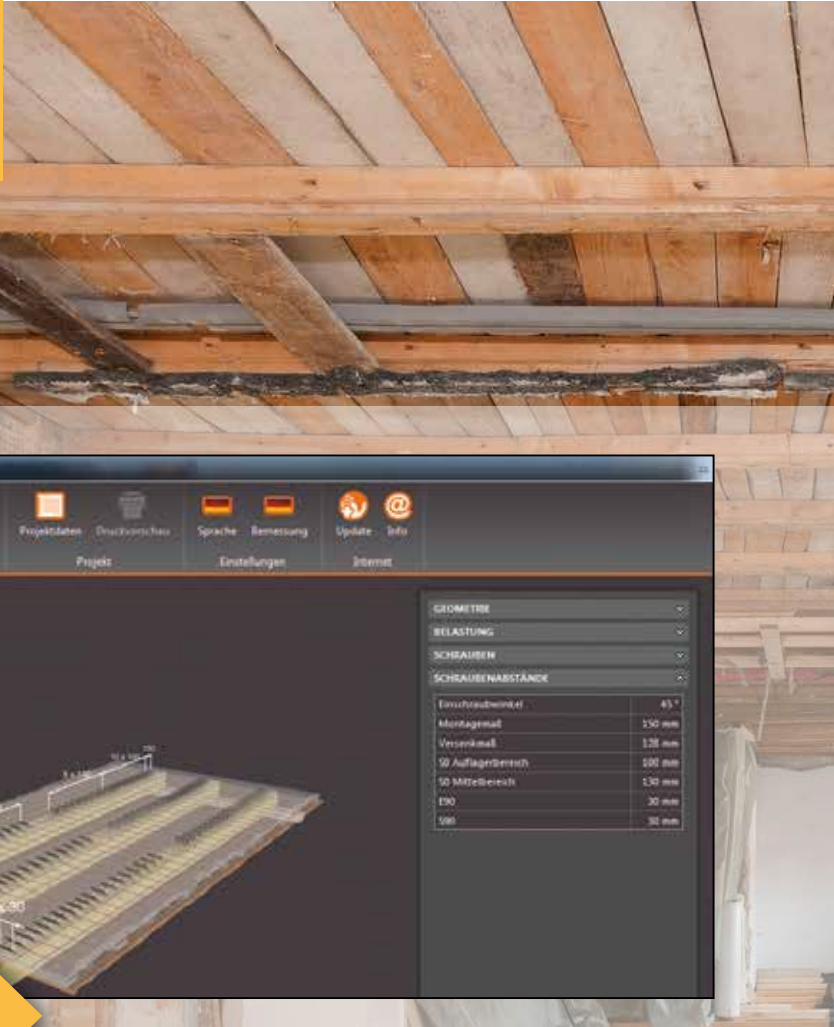

Please contact us:  
**Tel. +49 2331 - 62 45-444**  
**E-Mail [technik@eurotec.team](mailto:technik@eurotec.team)**

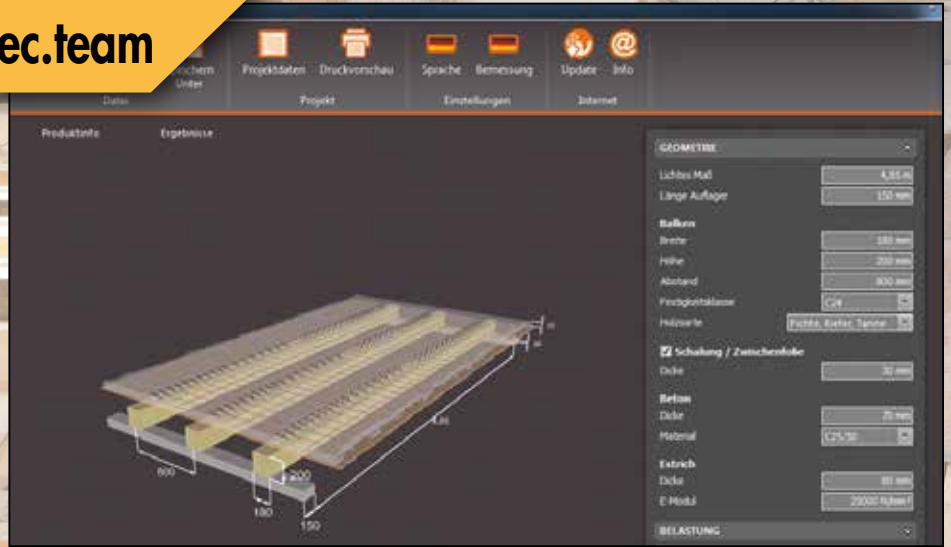



# A new era of wood connectors

We offer a solution for every load case occurring in solid wood and timber frame construction in the form of angles, straps, hook connectors or beam girders.

We are currently working flat out on unique solutions for system fasteners. These solutions are a system of all kinds of connections in modular and system design.

Our optimised screw patterns enable absorption of high tensile and shearing forces. Consequently, fewer fasteners are required.

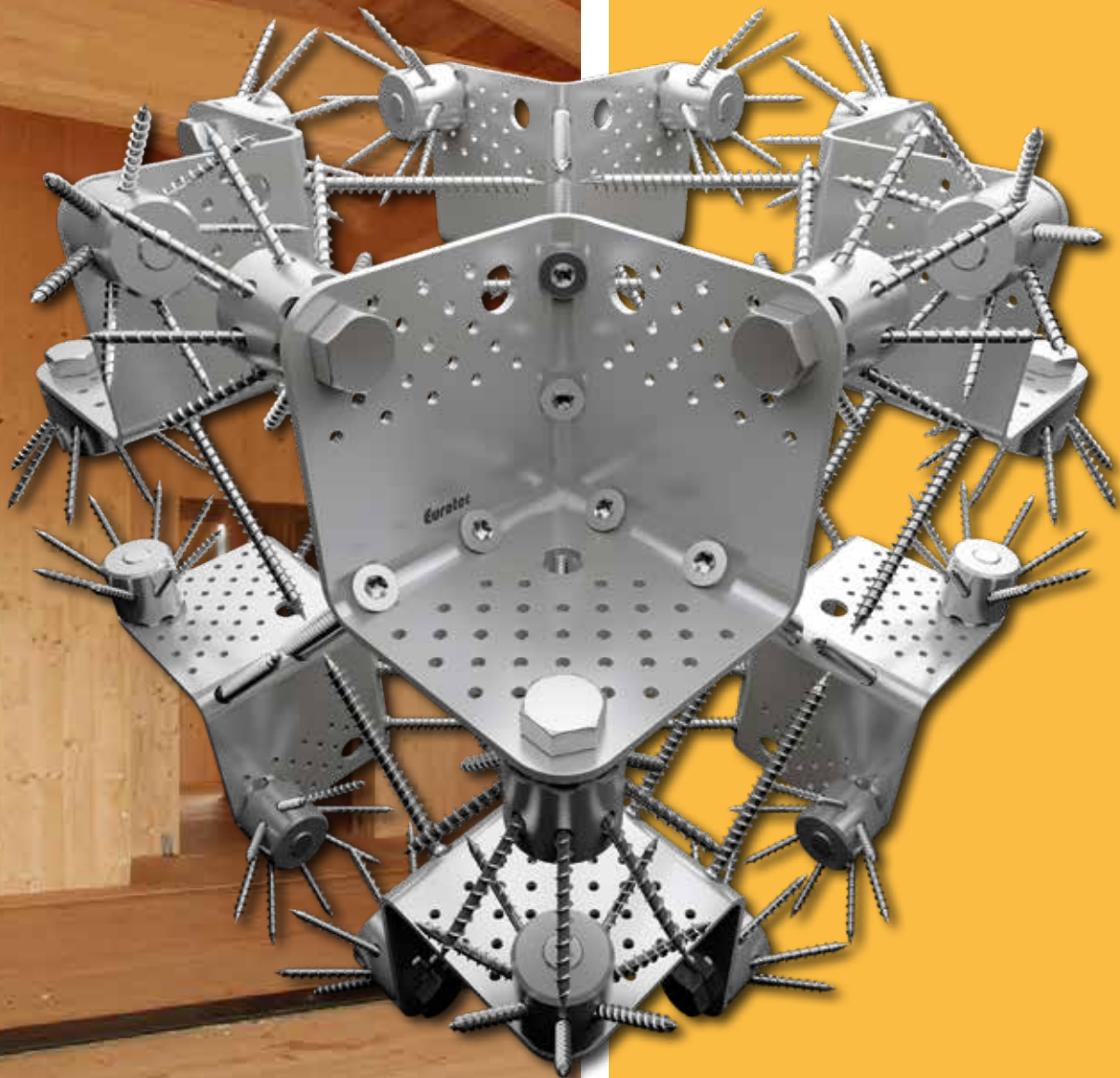

**Technical documentation is available from your Eurotec contact.**

# Possible applications

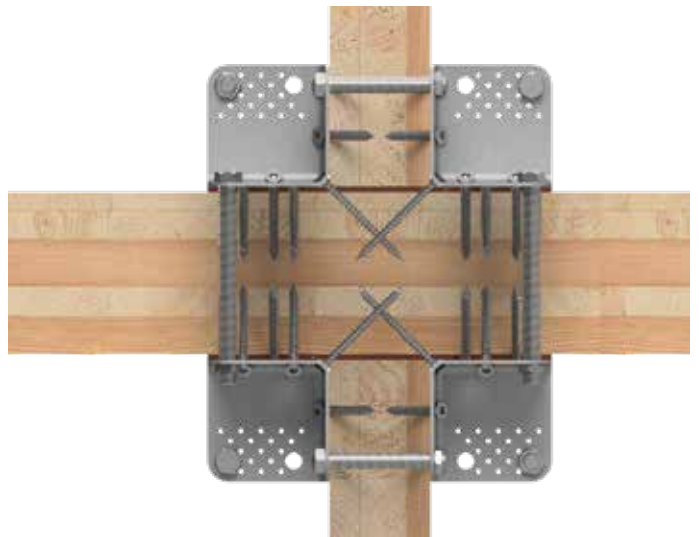
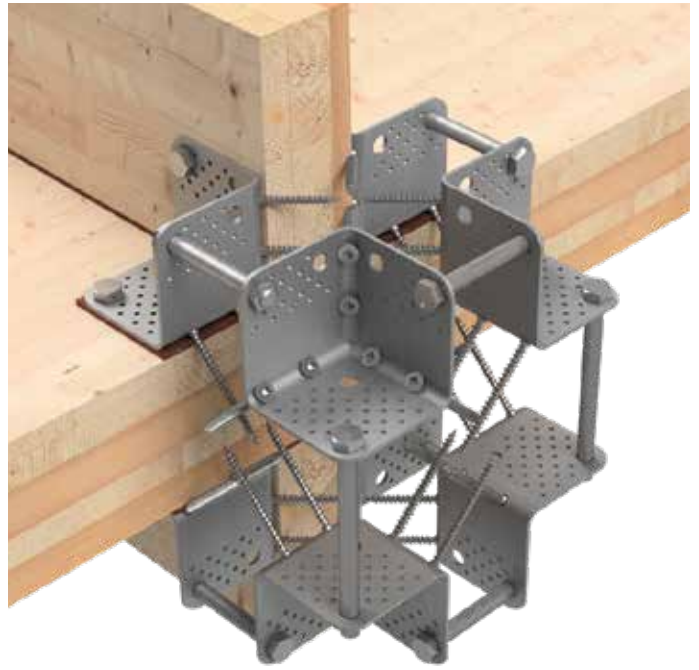
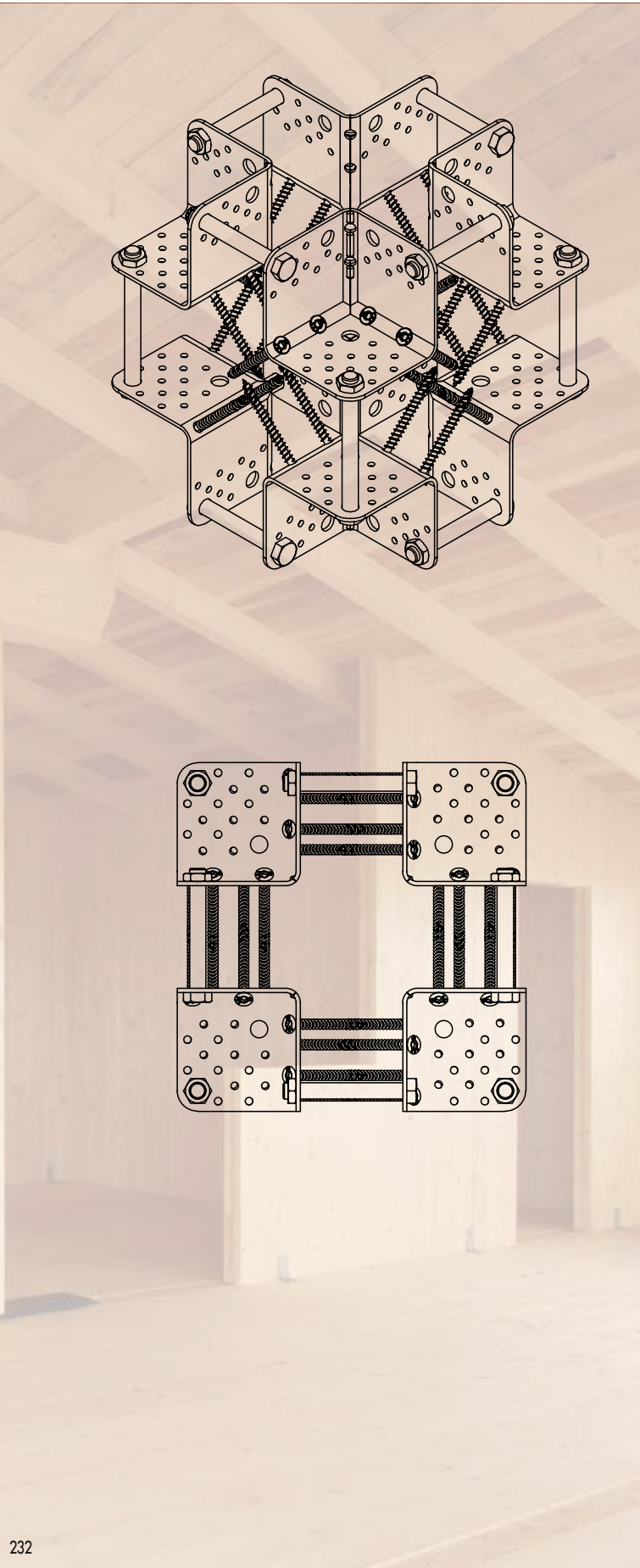



## Corner bracing in the tension and shearing direction



## Cantilever structures

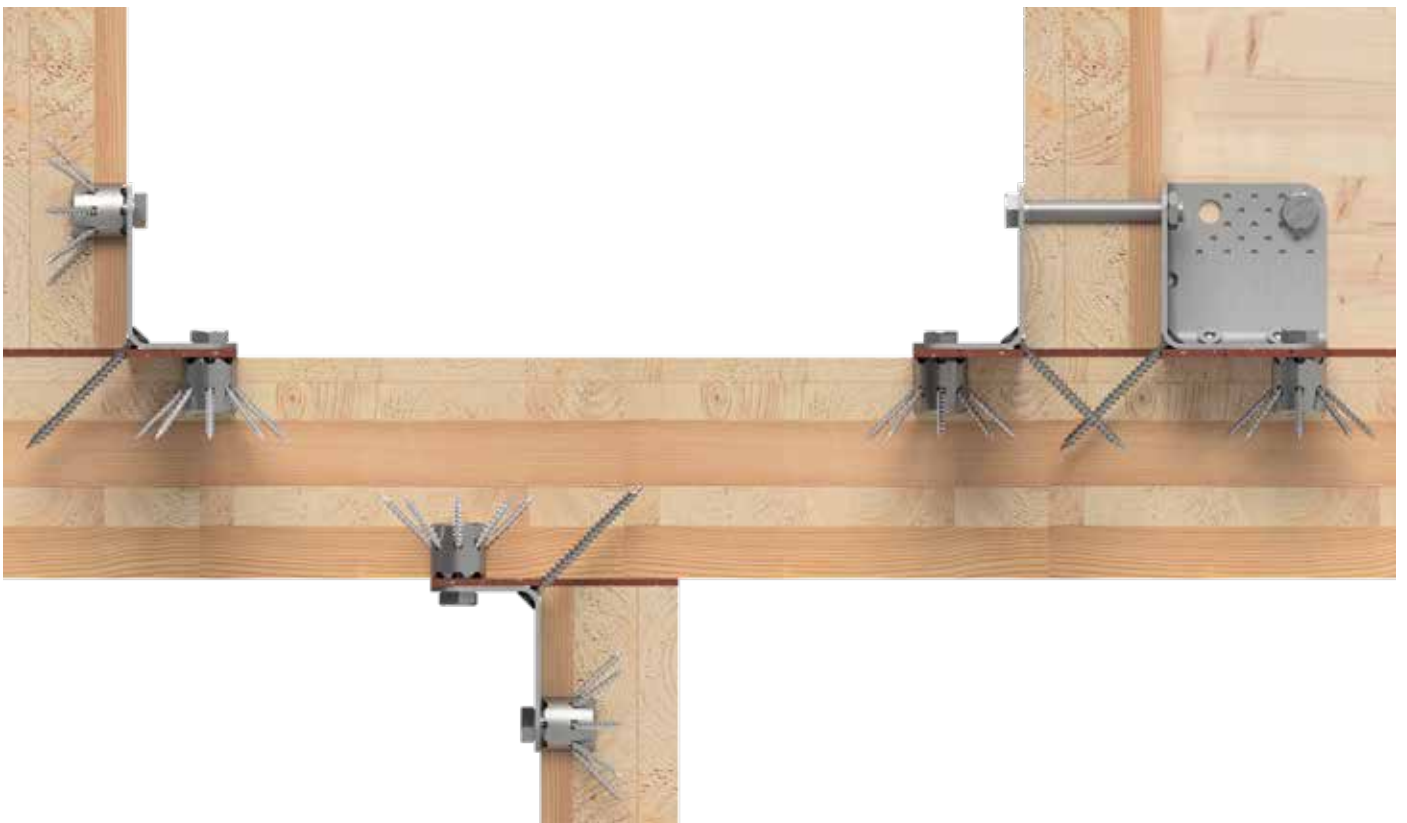

## Wall junction – visible solid wood ceiling

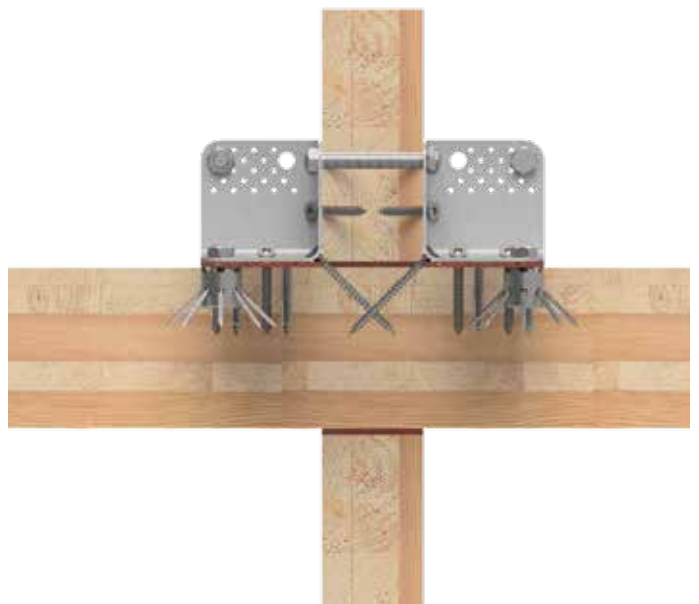
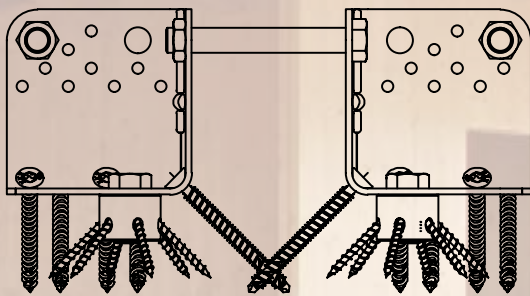
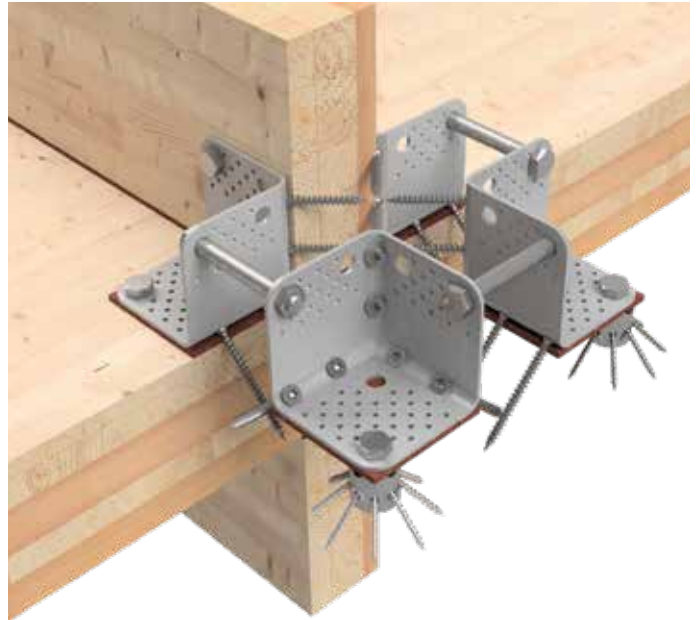
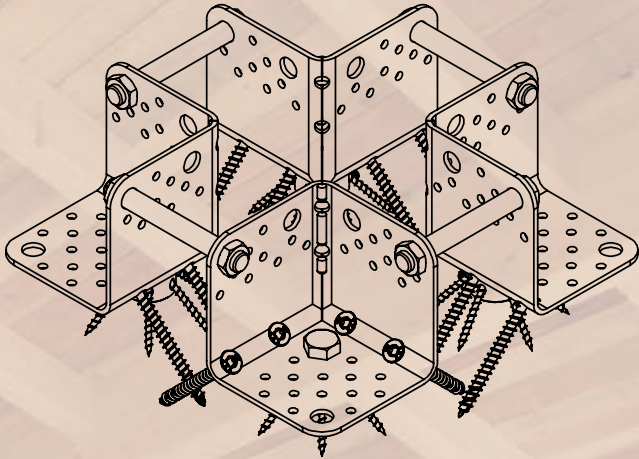

Sign up to the **NEWSLETTER**  
online now and never miss anything again.  
**[www.eurotec.team](http://www.eurotec.team)**





# Timber construction connectors

Connectors developed for modern timber construction



© Copyright Stora Enso

## What can it be used for?

- Timber frame and solid timber construction
- For installation in wood and concrete
- For absorbing tensile and shearing forces

## Advantages

- Many different fields of application
- High load-bearing capacity  
→ Fewer connectors required
- Indirect fixing due to an intermediate layer (e. g. OSB)
- Optimised hole pattern

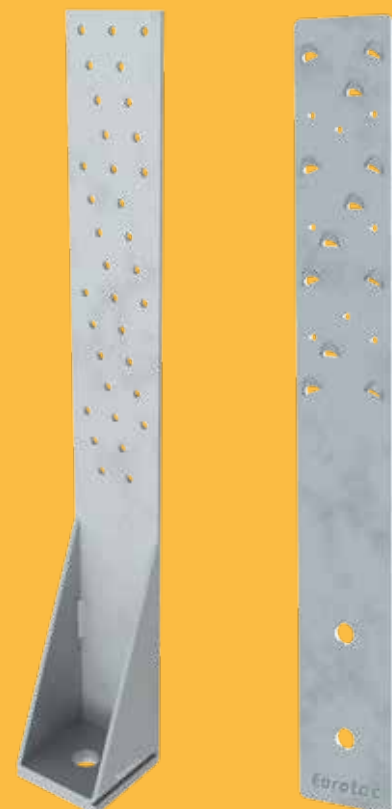

# Shearing angle, Shearing plate

Connectors for absorbing shearing forces developed for modern timber construction



## Shearing angle

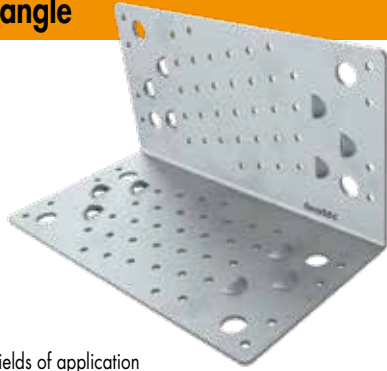

Art. no.	Dimensions [mm]	Material	Material thickness [mm]	PU
954112	230 x 120	S250 Galvanised	3	1

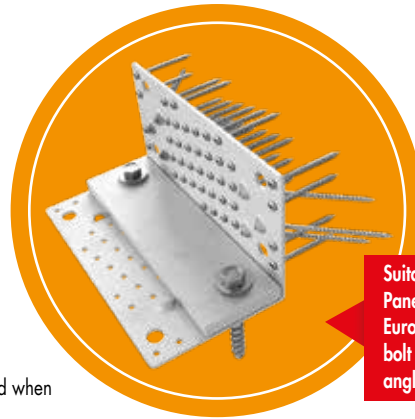

Suitable for this:  
Paneltwistec CH 5 x 120 mm,  
Eurotec rock concrete screw,  
bolt anchor, anchor nails and  
angle-bracket screw

### Advantages

- Many different fields of application
- For installation in wood and concrete
- Very high shear load-bearing capacity thanks to a new fixing concept
- Fewer connectors required
- In combination with the pressure plate, the following tensile forces can be absorbed when fixing in concrete

### Instructions for use

6 slanted screw connection holes and 41 holes, which are optionally intended for angle-bracket screws (ABSs) or anchor nails, are provided for anchoring in wood. Depending on the application, we have provided two additional partial utilisations of the fixing holes which are also available as static-type calculations. Anchoring in concrete is carried out using the holes (Ø 14 mm) provided for this purpose with our rock concrete screw Ø 12,5 mm or bolt anchors Ø 12 mm.

## Shearing angle pressure plate



Art. no.	Dimensions [mm]	Material	Material thickness [mm]	PU
954111	230 x 70	S235 Galvanised	12	1



## SonoTec Angular Decoupler



The Eurotec SonoTec Angular Decoupler forms the perfect complement to the Eurotec Shearing Angles and the CLT System Angle. The underlay is made from SK04, which is a compound formed from cork and natural rubber. The product is suitable for vibration damping applications in which very high insulation values are required. SonoTec angular decouplers are used as invisible insulators (pads/strips) with a low resonance frequency and a medium-low load.

### Advantages

- Underlay enables straightforward assembly
- Sustainable material
- Invisible
- High load capacity
- REACH-compliant

### Instructions for use

SonoTec angular decouplers feature cut-outs for concrete screws, making them suitable for use in concrete. The double layer allows an increase in the separation layer to 12 mm. The specifications for SonoTec SK04 Sound Insulation Cork apply. The material can be screwed through when used in wood. The application must be determined in advance by a structural engineer. No statement can be made regarding noise reduction since this is dependent on the construction.

Art. no.	Dimensions [mm]	Material	Suitable for	PU	
			Art. no.	Name	
945311	230 x 70 x 6	SK04	954088	HH flat shearing angle	5
945312	230 x 80 x 6	SK04	954180	CLT system angle	5
945314	230 x 100 x 6	SK04	954087	HB flat shearing angle	5
945313	230 x 120 x 6	SK04	954112	Shearing angle 120 x 230	5



## Shearing plate

Art. no.	Dimensions [mm]	Material	Material thickness [mm]	PU
954113	230 x 240	S250 Galvanised	3	1

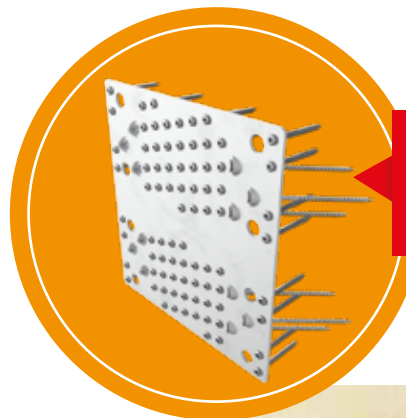

Suitable for this:  
Paneltwistec CH 5 x 120 mm,  
Eurotec rock concrete screw,  
bolt anchor, anchor nails and  
angle-bracket screw

### Advantages

- Many different fields of application
- For installation in wood and concrete
- Very high shear load-bearing capacity thanks to a new fixing concept
- Fewer connectors required

### Instructions for use

6 slanted screw connection holes and 41 holes, which are optionally intended for angle-bracket screws (ABSs) or anchor nails, are provided for anchoring in wood. Depending on the application, we have provided two additional partial utilisations of the fixing holes which are also available as static-type calculations. Anchoring in concrete is carried out using the holes (Ø 14 mm) provided for this purpose with our rock concrete screw Ø 12,5 mm or bolt anchors Ø 12 mm.



## Shearing angle – static full utilisation values



Load direction F2/F3						
Connection Timber-Timber						
Vertical leg connection	Anchor nails Ø 4 x 40 n=41	Anchor nails Ø 4 x 50 n=41	Anchor nails Ø 4 x 60 n=41	Angle-bracket screw Ø 5 x 40 n=41	Angle-bracket screw Ø 5 x 50 n=41	Angle-bracket screw Ø 5 x 60 n=41
	Panelwistec CH Ø 5 x 120 n=6					
Horizontal leg connection	Anchor nails Ø 4 x 40 n=41	Anchor nails Ø 4 x 50 n=41	Anchor nails Ø 4 x 60 n=41	Angle-bracket screw Ø 5 x 40 n=41	Angle-bracket screw Ø 5 x 50 n=41	Angle-bracket screw Ø 5 x 60 n=41
	Panelwistec CH Ø 5 x 120 n=6					
Char. Shear carrying capacity [kN]	30,5	36	37,2	41,9	44,6	47,6
Char. Shear carrying capacity [kN] (Verwendung Sonotec SK04)	22,6	26,6	27,5	32,7	34,8	37,1

Load direction F2/F3												
Connection Timber-Concrete												
Vertical leg connection	Anchor nails Ø 4 x 40 n=41	Anchor nails Ø 4 x 40 n=41	Anchor nails Ø 4 x 50 n=41	Anchor nails Ø 4 x 50 n=41	Anchor nails Ø 4 x 60 n=41	Anchor nails Ø 4 x 60 n=41	Angle-bracket screw Ø 5 x 40 n=41	Angle-bracket screw Ø 5 x 40 n=41	Angle-bracket screw Ø 5 x 50 n=41	Angle-bracket screw Ø 5 x 50 n=41	Angle-bracket screw Ø 5 x 60 n=41	Angle-bracket screw Ø 5 x 60 n=41
	Panelwistec CH Ø 5 x 120 n=6											
Horizontal leg connection	Rock concrete screws Ø 12,5 x 120 n=2	Bolt anchor Ø 12 x 110 n=2	Rock concrete screws Ø 12,5 x 120 n=2	Bolt anchor Ø 12 x 110 n=2	Rock concrete screws Ø 12,5 x 120 n=2	Bolt anchor Ø 12 x 110 n=2	Rock concrete screws Ø 12,5 x 120 n=2	Bolt anchor Ø 12 x 110 n=2	Rock concrete screws Ø 12,5 x 120 n=2	Bolt anchor Ø 12 x 110 n=2	Rock concrete screws Ø 12,5 x 120 n=2	Bolt anchor Ø 12 x 110 n=2
	incl. pressure plate 230 x 70											
Char. Shear carrying capacity [kN]	30,5	23,4	36,0	23,4	37,2	23,4	41,9	23,4	44,6	23,4	47,6	23,4

The load-bearing capacities were determined based on ETA-19/0020 Characteristic load-bearing capacity in kN, wood strength class 350 kg/m³ char. Gross density. The minimum distances between the connectors and the edges according to EC5 must be complied with.

Please note: Verify the assumptions made. The stated values, and type and number of joining devices are based on preliminary measurements. Projects are to be dimensioned exclusively by authorised persons in accordance with the State Building Code. As per LBauO, please contact a qualified structural engineer for a paid proof of stability. We will be happy to refer you to someone.

## Partial utilisation 1



Load direction F2/F3						
Connection Timber-Timber						
Vertical leg connection	Anchor nails Ø 4 x 40 n=34	Anchor nails Ø 4 x 50 n=34	Anchor nails Ø 4 x 60 n=34	Angle-bracket screw Ø 5 x 40 n=34	Angle-bracket screw Ø 5 x 50 n=34	Angle-bracket screw Ø 5 x 60 n=34
	Panelwistec CH Ø 5 x 120 n=6					
Horizontal leg connection	Anchor nails Ø 4 x 40 n=34	Anchor nails Ø 4 x 50 n=34	Anchor nails Ø 4 x 60 n=34	Angle-bracket screw Ø 5 x 40 n=34	Angle-bracket screw Ø 5 x 50 n=34	Angle-bracket screw Ø 5 x 60 n=34
	Panelwistec CH Ø 5 x 120 n=6					
Char. Shear carrying capacity [kN]	23,9	28,1	29,1	32,7	34,9	37,2
Char. Shear carrying capacity [kN] (Use of Sonotec SK04)	17,7	20,8	21,5	25,5	27,2	29



Load direction F2/F3												
Connection Timber-Concrete												
Vertical leg connection	Anchor nails Ø 4 x 40 n=34	Anchor nails Ø 4 x 40 n=34	Anchor nails Ø 4 x 50 n=34	Anchor nails Ø 4 x 50 n=34	Anchor nails Ø 4 x 60 n=34	Anchor nails Ø 4 x 60 n=34	Angle-bracket screw Ø 5 x 40 n=34	Angle-bracket screw Ø 5 x 40 n=34	Angle-bracket screw Ø 5 x 50 n=34	Angle-bracket screw Ø 5 x 50 n=34	Angle-bracket screw Ø 5 x 60 n=34	Angle-bracket screw Ø 5 x 60 n=34
	Paneltwistec CH Ø 5 x 120 n=6											
Horizontal leg connection	Rock concrete screws Ø 12,5 x 120 n=2	Bolt anchor Ø 12 x 110 n=2	Rock concrete screws Ø 12,5 x 120 n=2	Bolt anchor Ø 12 x 110 n=2	Rock concrete screws Ø 12,5 x 120 n=2	Bolt anchor Ø 12 x 110 n=2	Rock concrete screws Ø 12,5 x 120 n=2	Bolt anchor Ø 12 x 110 n=2	Rock concrete screws Ø 12,5 x 120 n=2	Bolt anchor Ø 12 x 110 n=2	Rock concrete screws Ø 12,5 x 120 n=2	Bolt anchor Ø 12 x 110 n=2
	incl. pressure plate 230 x 70											
Char. Shear carrying capacity [kN]	23,9	23,4	28,1	23,4	29,1	23,4	32,7	23,4	34,9	23,4	37,2	23,4

The load-bearing capacities were determined based on ETA-19/0020 Characteristic load-bearing capacity in kN, wood strength class 350 kg/m<sup>3</sup> char. Gross density. The minimum distances between the connectors and the edges according to ECS must be complied with.

Please note: Verify the assumptions made. The stated values, and type and number of joining devices are based on preliminary measurements. Projects are to be dimensioned exclusively by authorised persons in accordance with the State Building Code. As per LBau0, please contact a qualified structural engineer for a paid proof of stability. We will be happy to refer you to someone.

## Partial utilisation 2



Load direction F2/F3						
Connection Timber-Timber						
Vertical leg connection	Anchor nails Ø 4 x 40 n=29	Anchor nails Ø 4 x 50 n=29	Anchor nails Ø 4 x 60 n=29	Angle-bracket screw Ø 5 x 40 n=29	Angle-bracket screw Ø 5 x 50 n=29	Angle-bracket screw Ø 5 x 60 n=29
	Paneltwistec CH Ø 5 x 120 n=4					
Horizontal leg connection	Anchor nails Ø 4 x 40 n=29	Anchor nails Ø 4 x 50 n=29	Anchor nails Ø 4 x 60 n=29	Angle-bracket screw Ø 5 x 40 n=29	Angle-bracket screw Ø 5 x 50 n=29	Angle-bracket screw Ø 5 x 60 n=29
	Paneltwistec CH Ø 5 x 120 n=4					
Char. Shear carrying capacity [kN]	19,3	22,8	23,6	26,5	28,3	30,1
Char. Shear carrying capacity [kN] (Use of Sonotec SK04)	14,3	16,9	17,5	20,7	22,1	23,5

Load direction F2/F3												
Connection Timber-Concrete												
Vertical leg connection	Anchor nails Ø 4 x 40 n=29	Anchor nails Ø 4 x 40 n=29	Anchor nails Ø 4 x 50 n=29	Anchor nails Ø 4 x 50 n=29	Anchor nails Ø 4 x 60 n=29	Anchor nails Ø 4 x 60 n=29	Angle-bracket screw Ø 5 x 40 n=29	Angle-bracket screw Ø 5 x 40 n=29	Angle-bracket screw Ø 5 x 50 n=29	Angle-bracket screw Ø 5 x 50 n=29	Angle-bracket screw Ø 5 x 60 n=29	Angle-bracket screw Ø 5 x 60 n=29
	Paneltwistec CH Ø 5 x 120 n=4											
Horizontal leg connection	Rock concrete screws Ø 12,5 x 120 n=2	Bolt anchor Ø 12 x 110 n=2	Rock concrete screws Ø 12,5 x 120 n=2	Bolt anchor Ø 12 x 110 n=2	Rock concrete screws Ø 12,5 x 120 n=2	Bolt anchor Ø 12 x 110 n=2	Rock concrete screws Ø 12,5 x 120 n=2	Bolt anchor Ø 12 x 110 n=2	Rock concrete screws Ø 12,5 x 120 n=2	Bolt anchor Ø 12 x 110 n=2	Rock concrete screws Ø 12,5 x 120 n=2	Bolt anchor Ø 12 x 110 n=2
	incl. pressure plate 230 x 70											
Char. Shear carrying capacity [kN]	19,3	19,3	22,8	22,8	23,6	23,4	26,5	23,4	28,3	23,4	30,1	23,4

The load-bearing capacities were determined based on ETA-19/0020 Characteristic load-bearing capacity in kN, wood strength class 350 kg/m<sup>3</sup> char. Gross density. The minimum distances between the connectors and the edges according to ECS must be complied with.

Please note: Verify the assumptions made. The stated values, and type and number of joining devices are based on preliminary measurements. Projects are to be dimensioned exclusively by authorised persons in accordance with the State Building Code. As per LBau0, please contact a qualified structural engineer for a paid proof of stability. We will be happy to refer you to someone.

## Shearing plate – static full utilisation values

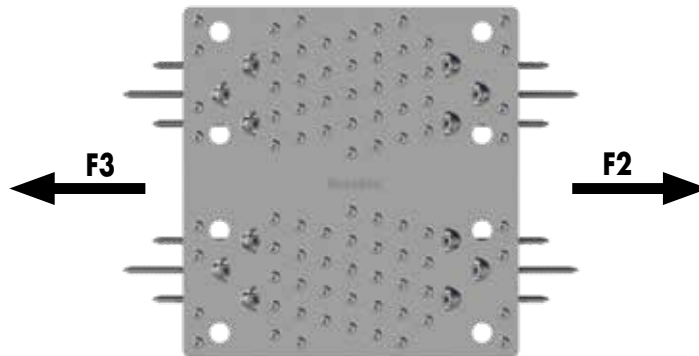

Load direction F2/3								
Timber/Timber	Fixing in the sole plate and solid timber ceiling							Steel
	Joining devices							
		Anchor nails			Angle-bracket screw			Panelwistec CH
Dimensions [mm]	4 x 40	4 x 50	4 x 60	5 x 40	5 x 50	5 x 60	5 x 120	S250
Quantity (n)		41			41		6	
Char. Shear carrying capacity [kN]	30,5	36	37,2	41,9	44,6	47,6	–	156

Load direction F2/3										
Timber/Concrete	Fixing in the sole plate						Fixing in the concrete ceiling			Steel
	Joining devices									
		Anchor nails			Angle-bracket screw			Panelwistec CH	Rock concrete screws	Bolt anchor
Dimensions [mm]	4 x 40	4 x 50	4 x 60	5 x 40	5 x 50	5 x 60	5 x 120	Ø 12,5	Ø 12	S250
Quantity (n)		41			41		6	2	2	
Char. Shear carrying capacity [kN]	30,5	36	37,2	41,9	44,6	47,6	–	21,8	12,2	156

The load-bearing capacities were determined based on ETA-19/0020 Characteristic load-bearing capacity in kN, wood strength class 350 kg/m<sup>3</sup> char. Gross density.  
The minimum distances between the connectors and the edges according to EC5 must be complied with. Boundary bearing force according to EC3: F<sub>b,R</sub>, ø14mm = 93,75 kN

Please note: Verify the assumptions made. The stated values, and type and number of joining devices are based on preliminary measurements. Projects are to be dimensioned exclusively by authorised persons in accordance with the State Building Code. As per LBauQ, please contact a qualified structural engineer for a paid proof of stability. We will be happy to refer you to someone.

## Partial utilisation 1



Load direction F2/3								
Timber/Timber	Fixing in the sole plate and solid timber ceiling							Steel
	Joining devices							
		Anchor nails			Angle-bracket screw			Panelwistec CH
Dimensions [mm]	4 x 40	4 x 50	4 x 60	5 x 40	5 x 50	5 x 60	5 x 120	S250
Quantity (n)		34			34		6	
Char. Shear carrying capacity [kN]	23,9	28,1	29,1	32,7	34,9	37,2	–	156

Load direction F2/3											
Timber/Concrete	Fixing in the sole plate							Fixing in the concrete ceiling		Steel	
	Joining devices										
	Anchor nails			Angle-bracket screw			Panelwistec CH	Rock concrete screws	Bolt anchor		
Dimensions [mm]	4 x 40	4 x 50	4 x 60	5 x 40	5 x 50	5 x 60	5 x 120	Ø 12,5	Ø 12	S250	
Quantity (n)	34			34			6	2	2		
Char. Shear carrying capacity [kN]	23,9	28,1	29,1	32,7	34,9	37,2	–	20,5	11,6	156	

The load-bearing capacities were determined based on ETA-19/0020 Characteristic load-bearing capacity in kN, wood strength class 350 kg/m<sup>3</sup> char. Gross density.

The minimum distances between the connectors and the edges according to EC5 must be complied with. Boundary bearing force according to EC3:  $F_b, R_b, \phi 14\text{mm} = 93,75\text{ kN}$

Please note: Verify the assumptions made. The stated values, and type and number of joining devices are based on preliminary measurements. Projects are to be dimensioned exclusively by authorised persons in accordance with the State Building Code. As per LBauO, please contact a qualified structural engineer for a paid proof of stability. We will be happy to refer you to someone.

## Partial utilisation 2



Load direction F2/3											
Timber/Timber	Fixing in the sole plate and solid timber ceiling							Steel			
	Joining devices										
	Anchor nails			Angle-bracket screw			Panelwistec CH				
Dimensions [mm]	4 x 40	4 x 50	4 x 60	5 x 40	5 x 50	5 x 60	5 x 120			S250	
Quantity (n)	29			29			4				
Char. Shear carrying capacity [kN]	19,3	22,8	23,6	26,5	28,3	30,1	–			156	

Load direction F2/3											
Timber/Concrete	Fixing in the sole plate							Fixing in the concrete ceiling		Steel	
	Joining devices										
	Anchor nails			Angle-bracket screw			Panelwistec CH	Rock concrete screws	Bolt anchor		
Dimensions [mm]	4 x 40	4 x 50	4 x 60	5 x 40	5 x 50	5 x 60	5 x 120	Ø 12,5	Ø 12	S250	
Quantity (n)	29			29			4	2	2		
Char. Shear carrying capacity [kN]	19,3	22,8	23,6	26,5	28,3	30,1	–	14,4	11,2	156	

The load-bearing capacities were determined based on ETA-19/0020 Characteristic load-bearing capacity in kN, wood strength class 350 kg/m<sup>3</sup> char. Gross density.

The minimum distances between the connectors and the edges according to EC5 must be complied with. Boundary bearing force according to EC3:  $F_b, R_b, \phi 14\text{mm} = 93,75\text{ kN}$

Please note: Verify the assumptions made. The stated values, and type and number of joining devices are based on preliminary measurements. Projects are to be dimensioned exclusively by authorised persons in accordance with the State Building Code. As per LBauO, please contact a qualified structural engineer for a paid proof of stability. We will be happy to refer you to someone.

# CLT system angle



## CLT system angle

Art. no.	Dimensions [mm] <sup>a)</sup>	Material	Material thickness [mm]	PU
954180	230 x 80 x 120	S250 Galvanised	4	1

a) Length x width x height

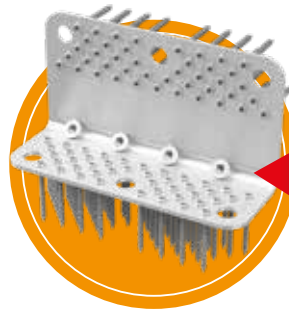

Suitable for use with:  
IdeeFix, KonstruX and  
Angle-bracket screw

### Advantages

- High load bearing capacity
- Variable applications
- Compatible with SK04

### Description

The CLT system angle is ideally suited for use in solid wood construction. The scope of application is limited to the use of CLT (cross-laminated timber). The solid construction allows it to transmit major forces. Unlike the standard angles, the CLT system angle can be combined with our IdeeFix. This makes it possible to construct complex connections.

### Instructions for use

Either 5 x 60 mm angle fitting screws in combination with the KonstruX SK 10 x 125 mm, are used for the CLT system angle. When used with IdeeFix, only 4 IdeeFix and 4 KonstruX are needed – see application picture. It is also possible to combine IdeeFix and screw bolts through a wall. The load values of the ETA must be observed. For further information, please contact our technical department [technik@eurotec.team](mailto:technik@eurotec.team) or +49 2331 6245-444.



Suitable for use with:  
SonoTec Angular Decoupler  
(Art. no. 945312)  
Find more information on  
p. 237



Application with IdeeFix, Bolt, KonstruX



Application with Angle-bracket screw, KonstruX



# Connection with CLT system bracket

Load direction F1; F2/F3; F5												
Vertical leg connection Angle-bracket screw Ø 5 mm n=43	5,0 x 40	5,0 x 50	5,0 x 60	5,0 x 70	5,0 x 40	5,0 x 50	5,0 x 60	5,0 x 70	5,0 x 40	5,0 x 50	5,0 x 60	5,0 x 70
Horizontal leg connection	Angle-bracket screw 5,0 x 40 n=43	Angle-bracket screw 5,0 x 50 n=43	Angle-bracket screw 5,0 x 60 n=43	Angle-bracket screw 5,0 x 70 n=43	IdeeFix Ø 40 n=3	IdeeFix Ø 40 n=3	IdeeFix Ø 40 n=3	IdeeFix Ø 40 n=3	M16 8.8 n=3	M16 8.8 n=3	M16 8.8 n=3	M16 8.8 n=3
KonstruX 10 x 125 n=4												
$F_{1, \text{rk}}$ pull	55,8 kN	62,4 kN	69,1 kN	75,7 kN	43,1 kN	43,1 kN	43,1 kN	43,1 kN	43,1 kN	43,1 kN	43,1 kN	43,1 kN
$F_{23, \text{rk}}$	49,1 kN	58,3 kN	62,1 kN	66,0 kN	49,1 kN	55,9 kN	55,9 kN	55,9 kN	49,1 kN	58,3 kN	62,1 kN <i>60,5 kN</i>	66,0 kN <i>60,5 kN</i>
$F_{5, \text{rk}}$ pull $\perp$ on CLT	6,9 kN	6,9 kN	6,9 kN	6,9 kN	6,9 kN	6,9 kN	6,9 kN	6,9 kN	6,9 kN	6,9 kN	6,9 kN	6,9 kN

Load direction F1; F2/F3; F5						
Vertical leg connection	IdeeFix Ø 40 n=3	IdeeFix Ø 40 n=2	IdeeFix Ø 40 n=3	IdeeFix Ø 40 n=2	IdeeFix Ø 40 n=3	IdeeFix Ø 40 n=2
Horizontal leg connection	Angle-bracket screw 5,0 x 40;50;60;70 n=43	Angle-bracket screw 5,0 x 40;50;60;70 n=43	IdeeFix Ø 40 n=3	IdeeFix Ø 40 n=2	M16 8.8 n=3	M16 8.8 n=2
KonstruX 10 x 125 n=4						
$F_{1, \text{rk}}$ pull	43,1 kN	29,9 kN	43,1 kN	29,9 kN	43,1 kN	29,9 kN
$F_{23, \text{rk}}$	26,0 kN	22,3 kN	26,0 kN	22,3 kN	26,0 kN	22,3 kN
$F_{5, \text{rk}}$ pull $\perp$ on CLT	4,8 kN	4,8 kN	4,8 kN	4,8 kN	4,8 kN	4,8 kN

Load direction F1; F2/F3; F5						
Vertical leg connection	M16 8.8 n=3	M16 8.8 n=2	M16 8.8 n=3	M16 8.8 n=2	M16 8.8 n=3	M16 8.8 n=2
Horizontal leg connection	Angle-bracket screw 5,0 x 40;50;60;70 n=43	Angle-bracket screw 5,0 x 40;50;60;70 n=43	IdeeFix Ø 40 n=3	IdeeFix Ø 40 n=2	M16 8.8 n=3	M16 8.8 n=2
KonstruX 10 x 125 n=4						
$F_{1, \text{rk}}$ pull	43,1 kN	43,1 kN	43,1 kN	29,9 kN	43,1 kN	43,1 kN <i>36,7 kN</i>
$F_{23, \text{rk}}$	34,4 kN <i>29,3 kN</i>	29,6 kN <i>25,2 kN</i>	34,4 kN <i>29,3 kN</i>	29,6 kN <i>25,2 kN</i>	34,4 kN <i>29,3 kN</i>	29,6 kN <i>25,2 kN</i>
$F_{5, \text{rk}}$ pull $\perp$ on CLT	4,8 kN	4,8 kN	4,8 kN	4,8 kN	4,8 kN	4,8 kN

$F_{4, \text{rk}}=54$  kN pressure  $\perp$  on CLT; independent of connections.

For connections with M16 8.8 if bolt head or nut is not located on CLT: Washer with  $d_w=40$ mm.

$\rho_k=350$  kg/m<sup>3</sup> conservative for some approved cross-laminated timber, increase of load-bearing capacities according to ETA-19/0020 with  $k_{dens} = \left( \frac{\rho_k}{350 \text{ kg/m}^3} \right)^{0.5}$  possible.

The construction of the supporting structure should prevent the twisting of the cross laminated timber components.

In case of connection with CLT system angles on both sides, the values of this table may be applied for each of the two angles. The values for  $F_{23, \text{rk}}$  only change for the connection with M16 screws. In other words, the values in italics must be used if CLT system brackets are fitted to the top and bottom of the ceiling.

# HB flat shearing angle



## HB flat shearing angle

Art. no.	Dimensions [mm] <sup>a)</sup>	Material	Material thickness [mm]	PU
954087	230 x 100 x 70	S250 Galvanised	3	1
<b>Shearing angle pressure plate</b>				
954111	230 x 68	S235 Galvanised	12	1

a) Length x width x height



Suitable for use with:  
SonoTec Angular Decoupler  
(Art. no. 945314)  
Find more information on  
p.237

### Advantages

- For assembly on concrete
- Very high shear load-bearing capacity thanks to a new fixing concept
- Fewer connectors required
- In combination with the pressure plate, tensile forces can also be absorbed when fixing in concrete

### Description

The HB flat shearing angle (wood/concrete) is a bracket connector for absorbing shearing forces that was specifically developed for modern timber construction. Its low height means it is ideally suited to use in timber frame construction. The pressure plate allows the occurring loads to be optimally conducted into the concrete.





# HH flat shearing angle

## HH flat shearing angle

Art. no.	Dimensions [mm] <sup>a)</sup>	Material	Material thickness [mm]	PU
954088	230 x 70	S250 Galvanised	3	1

a) Length x width



Suitable for use with:  
**SonoTec Angular Decoupler**  
 (Art. no. 945311)  
 Find more information on  
 p. 237

### Advantages

- For assembly on timber
- Very high shear load-bearing capacity thanks to a new fixing concept
- Fewer connectors required
- Especially high tensile forces can be absorbed in combination with the KonstruX

### Description

The HH flat shearing angle (wood/wood) is a bracket connector for absorbing shearing forces that was specifically developed for modern timber construction. Its low height means it is ideally suited to use in timber frame construction.



## HB flat shearing angle - static values



Load direction F2/F3/F4		
Connection Timber-Concrete		
Vertical leg connection	Angle-bracket screw Ø 5 x 25 n=3 Panelwistec CH Ø 5 x 120 n=12	
Horizontal leg connection	Rock concrete screws Ø 12,5 x 120 n=2	Bolt anchor Ø 12 x 110 n=2
	incl. pressure plate 230 x 68 x 12	
Char. Shear carrying capacity $F_{23}$ [kN]	40,0	23,9
Char. bearing capacity $F_1$ [kN]	40,0	40,0

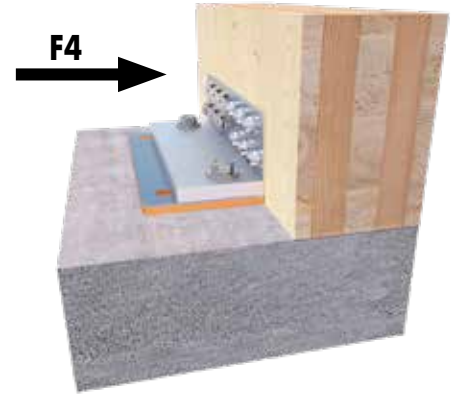

The load-bearing capacities were determined based on ETA-19/0020 Characteristic load-bearing capacity in kN, wood strength class 350 kg/m<sup>3</sup> char. Gross density. The minimum distances between the connectors and the edges according to EC5 must be complied with.

Please note: Verify the assumptions made. The stated values, and type and number of joining devices are based on preliminary measurements. Projects are to be dimensioned exclusively by authorised persons in accordance with the State Building Code. As per LBauO, please contact a qualified structural engineer for a paid proof of stability. We will be happy to refer you to someone.

## HH flat shearing bracket - static values



Load direction F2/F3/F4	
Connection Timber-Timber	
Vertical leg connection	Angle-bracket screw Ø 5 x 25 n=3 Panelwistec CH Ø 5 x 120 n=12
Horizontal leg connection	Angle-bracket screw Ø 5 x 25 n=3
	Panelwistec CH Ø 5 x 120 n=12
Char. Shear carrying capacity $F_{23}$ [kN]	40,0
Char. Shear carrying capacity $F_{23}$ [kN] (Use of Sonotec SK04)	36,0
Char. bearing capacity $F_1$ [kN]	40,0
Char. bearing capacity $F_{23}$ [kN] (Use of Sonotec SK04)	36,0

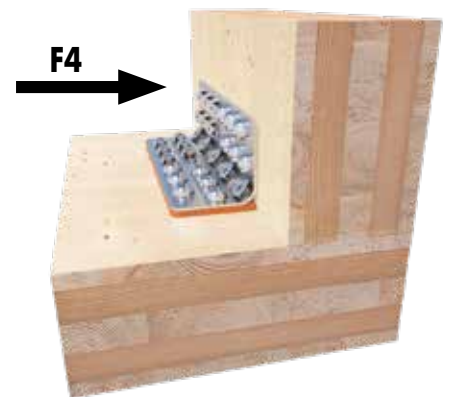

The load-bearing capacities were determined based on ETA-19/0020 Characteristic load-bearing capacity in kN, wood strength class 350 kg/m<sup>3</sup> char. Gross density. The minimum distances between the connectors and the edges according to EC5 must be complied with.

Please note: Verify the assumptions made. The stated values, and type and number of joining devices are based on preliminary measurements. Projects are to be dimensioned exclusively by authorised persons in accordance with the State Building Code. As per LBauO, please contact a qualified structural engineer for a paid proof of stability. We will be happy to refer you to someone.





# Tension rod 340/440

Moulded sheet steel parts especially for timber frame construction for transfer of tensile forces

## Tension rod 340/440

Art. no.	Dimensions [mm]	Material	Material thickness [mm]	PU
954099	340 x 63	S355 Galvanised	3	1
954100	440 x 63	S355 Galvanised	3	1
<b>Pressure plate</b>				
954110	50 x 58	S355 Galvanised	10	1

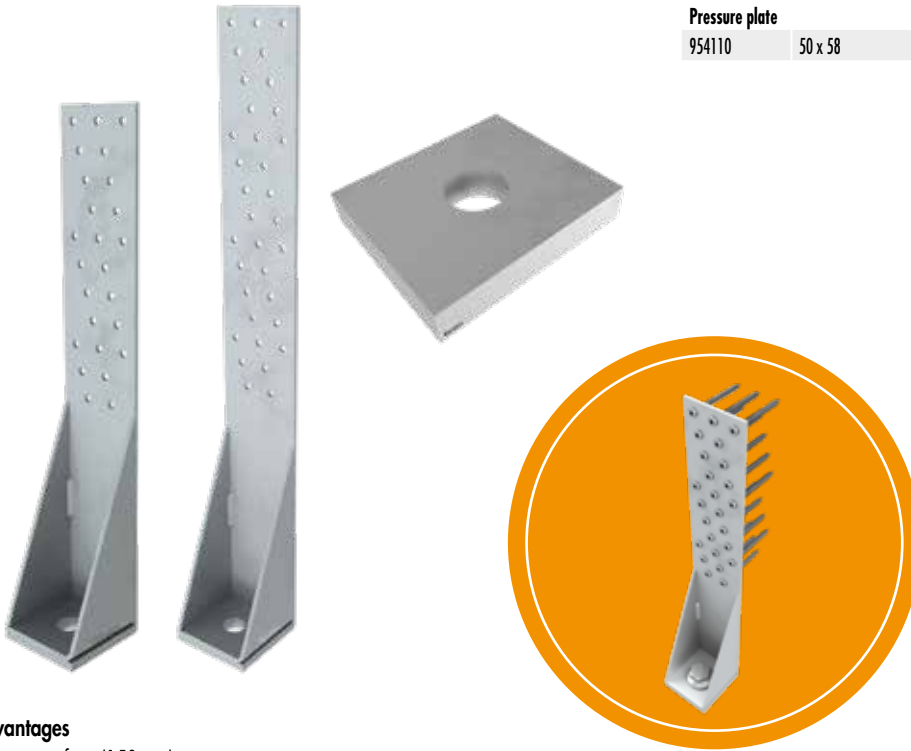

### Advantages

- Short root face (150 mm)
- Indirect fixing due to an intermediate layer (e. g. OSB)
- For installation in wood and concrete
- Optimised screw pattern for very high tensile capacities
- The tensile force can also be increased in combination with the pressure plate

### Instructions for use

The tension rods are placed on the planking in the floor area and fastened to the stem and, if necessary, to the sole plate with screws or anchor nails. In this regard, the connection can safely transfer tensile, suction and shearing forces into the tension rod via the screws and finally into the base plates via a dowel.



## Tension rod 340/440 - static values

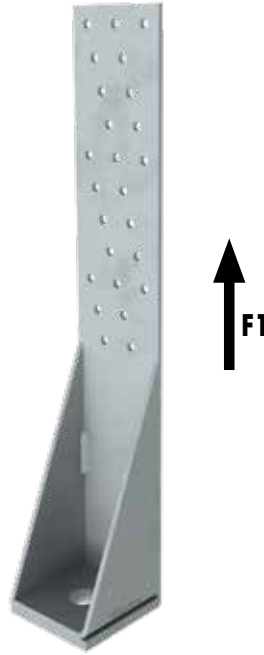

Tension rod 340															
Load alignment F1 (with pressure plate)															
Timber/Concrete	Fixing in the support						Fixing in uncracked concrete				Fixing in cracked concrete				Steel
	Joining devices														
	Anchor nails			Angle-bracket screw			Rock concrete screws		Bolt anchor		Rock concrete screws		Bolt anchor		
Dimensions [mm]	4 x 40	4 x 50	4 x 60	5 x 40	5 x 50	5 x 60	Ø 12,5	Ø 16,5	Ø 12	Ø 16	Ø 12,5	Ø 16,5	Ø 12	Ø 16	S355
Quantity (n)	25			25			1		1		1		1		
Char. tensile capacity [kN]	28,3	33,4	34,4	38,8	41,3	44	25	40	20	35	12	30	20	35	47,9

The load-bearing capacities were determined based on ETA-19/0020 Characteristic load-bearing capacity in kN, wood strength class 350 kg/m³ char. Gross density. The minimum distances between the connectors and the edges according to EC5 must be complied with.

Tension rod 440															
Load alignment F1 (with pressure plate)															
Timber/Concrete	Fixing in the support						Fixing in uncracked concrete				Fixing in cracked concrete				Steel
	Joining devices														
	Anchor nails			Angle-bracket screw			Rock concrete screws		Bolt anchor		Rock concrete screws		Bolt anchor		
Dimensions [mm]	4 x 40	4 x 50	4 x 60	5 x 40	5 x 50	5 x 60	Ø 12,5	Ø 16,5	Ø 12	Ø 16	Ø 12,5	Ø 16,5	Ø 12	Ø 16	S355
Quantity (n)	34						1		1		1		1		
Char. tensile capacity [kN]	37,3	44	45,4	51,1	54,5	58	25	40	20	35	12	30	20	35	47,9

The load-bearing capacities were determined based on ETA-19/0020 Characteristic load-bearing capacity in kN, wood strength class 350 kg/m³ char. Gross density. The minimum distances between the connectors and the edges according to EC5 must be complied with.



# HighLoad tension rod

## HighLoad tension rod



### Advantages

- Short root face (150 mm)
- Ideal for anchoring cross-laminated timber elements (CLT)
- Indirect fixing due to an intermediate layer (e. g. OSB)
- For installation in concrete, wood and steel
- Optimised screw pattern and geometry for very high tensile capacities

### Description

The HighLoad tension rod is a steel-plate shaped part especially designed for transmitting very high tensile forces in timber construction. It was developed to meet the requirements of modern timber buildings (complex hall buildings, multi-storey buildings, and so on). It is able to handle exceptionally high loads.

Art. no.	Dimensions [mm]	Material	Material thickness [mm]	PU
954114	750 x 140 x 85	S250 Galvanised	3	1
<b>Pressure plate</b>				
954178	130 x 82	S235 Galvanised	40	1



## HighLoad tension rod - static values

Timber/Concrete	Load direction F1								Steel	
	Fixing in the support					Fixing in uncracked concrete				
	Anchor nails		Angle-bracket screw			Anchor rod (injection)	Bolt anchor			
	Dimensions [mm]	Quantity [n]	Char. tensile capacity [kN]	Dimensions [mm]	Quantity [n]	Char. tensile capacity [kN]	Dimensions [mm]	Quantity [n]		Char. tensile capacity [kN]
	4 x 40	4 x 50	4 x 60	5 x 40	5 x 50	5 x 60	Ø 27	Ø 27	S355	
		81			81		1	1		
		81,4	96,04	99,1	111,7	119	126,8	-	-	104,3

Wood strength class 350 kg/m³ char. Gross density.

The minimum distances between the connectors and the edges according to EC5 must be complied with.

# Simply tie bar

Anchor timber-frame constructions securely against tension



## Simply tie bar

Slot, galvanised



Art. no.	Dimensions [mm] <sup>a)</sup>	Material thickness [mm]	PU
954056	95 x 88 x 65	4	25
954057	135 x 88 x 65	4	25
954058	285 x 88 x 65	4	25

a) Height x length x width

### For quick and easy connections

The Simply tie bar allows quick and easy timber / timber, timber / concrete, timber / steel and timber / brickwork connections. It is especially sturdy and can withstand extremely high loads. The Simply tie bar has nail holes on one side and screw holes (including a slot) in the other.

Tie bar	Holes	
	Ø [mm]	Quantity
Simply 95	5	9 + 2
	13,5 (x24,5)	0 + 1
	11	0 + 1
Simply 135	5	14 + 2
	13,5 (x24,5)	1 + 1
	11	0 + 1
Simply 285	5	28 + 2
	13,5 (x24,5)	3 + 1
	11	0 + 1

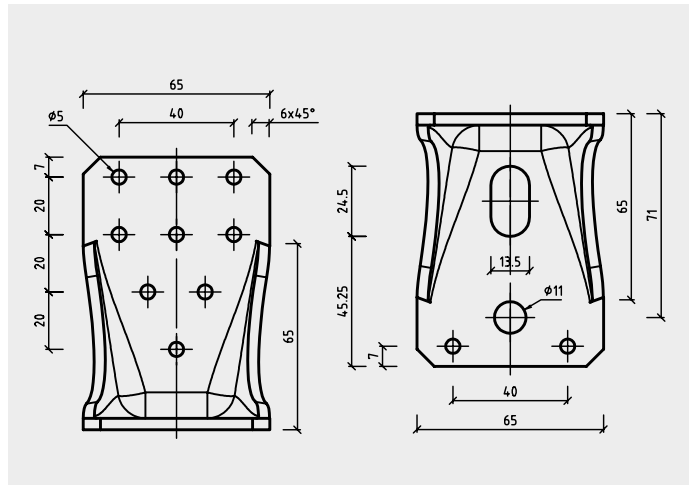

Simply 95

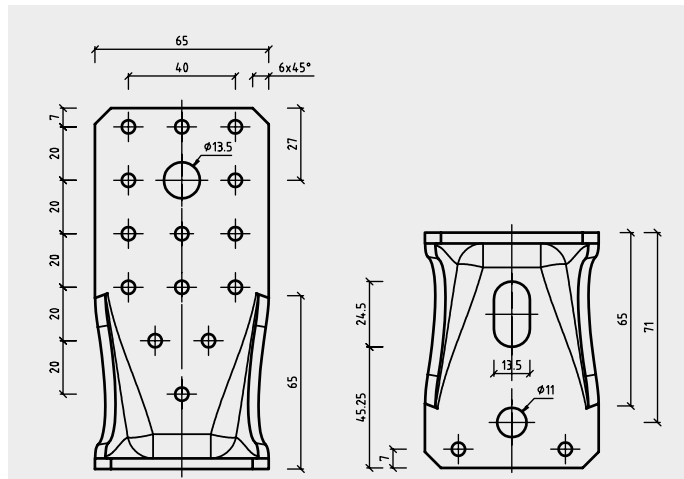

Simply 135

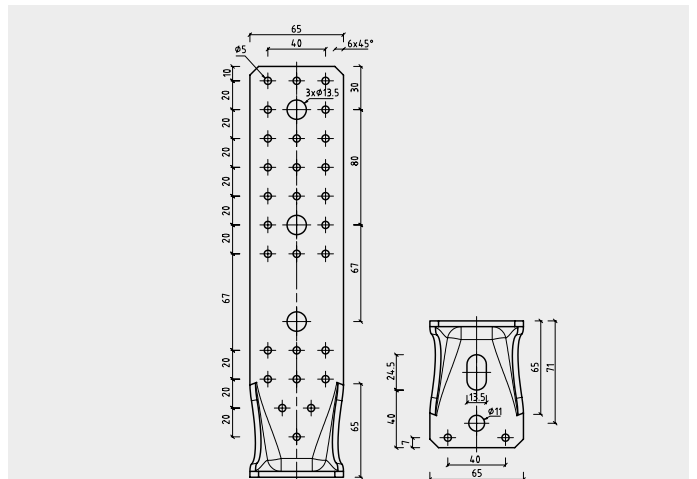

Simply 285





# Tension strap HH60/70, HB60/70

For absorbing tensile forces and tensile and shearing forces developed for modern timber construction

## Tension strap HH60/HH70

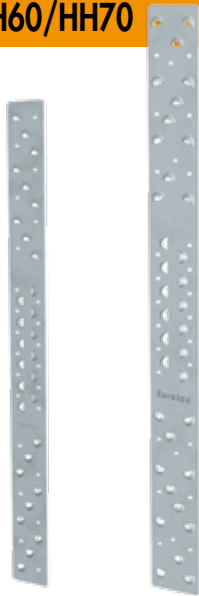

Art. no.	Dimensions [mm]	Material	Material thickness [mm]	PU
954096	680 x 60	S250 Galvanised	3	1
954098	740 x 70	S250 Galvanised	3	1

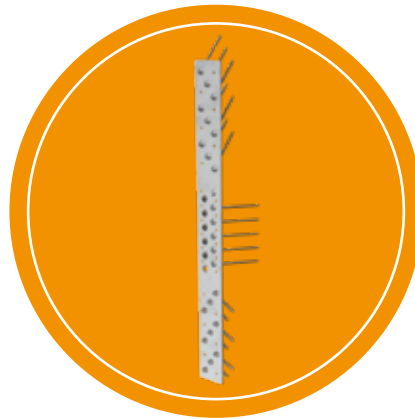

### Advantages

- Many different fields of application
- For installation in wood and concrete
- Very high shear load-bearing capacity thanks to a new fixing concept
- Fewer connectors required

### Instructions for use

Anchoring in wood is carried out using 5 x 120 mm countersunk-head screws at an angle of 45°. A non-positive connection is created between the screw head and draw shackle thanks to the specifically designed holes, which can also be used as screw guides. The tension strap HH70 also has two holes (Ø 5 mm) which are provided for a 90° screw connection. Detailed installation instructions can be found in the corresponding product data sheets.



## Tension strap HB60/HB70

Art. no.	Dimension [mm]	Material	Material thickness [mm]	PU
954095	506 x 60	S250 Galvanised	3	1
954097	506 x 70	S250 Galvanised	3	1

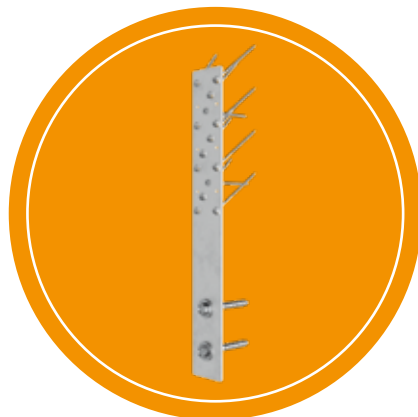
**Advantages**

- Many different fields of application
- For installation in wood and concrete
- Very high shear load-bearing capacity thanks to a new fixing concept
- Fewer connectors required

**Instructions for use**

Anchoring in wood is carried out using 5 x 120 mm countersunk-head screws at an angle of 45°. A non-positive connection is created between the screw head and draw shackle thanks to the specifically designed holes, which can also be used as screw guides.

The tension strap HB70 also has 2 holes (Ø 5 mm) which are provided for a 90° screw connection. Anchoring in concrete is carried out using the holes (Ø 14 mm) provided for this purpose with our rock concrete screw or bolt anchors. Detailed installation instructions can be found in the corresponding product data sheets.



## Tension strap HH60 – static values



Load direction F1								
Connection Timber-Timber								
Leg connection 1	Panelwister CH Ø 5 x 120 n= 9	Anchor nails Ø 4 x 40 n=6	Anchor nails Ø 4 x 50 n=6	Anchor nails Ø 4 x 60 n=6	Angle-bracket screw Ø 5 x 40 n=6	Angle-bracket screw Ø 5 x 50 n=6	Angle-bracket screw Ø 5 x 60 n=6	Steel S250
Leg connection 2	Panelwister CH Ø 5 x 120 n= 9	Anchor nails Ø 4 x 40 n=6	Anchor nails Ø 4 x 50 n=6	Anchor nails Ø 4 x 60 n=6	Angle-bracket screw Ø 5 x 40 n=6	Angle-bracket screw Ø 5 x 50 n=6	Angle-bracket screw Ø 5 x 60 n=6	Steel S250
Char. tensile capacity [kN]	27	9,4	11	11,4	10,9	12	13,1	28,5

The load-bearing capacities were determined based on ETA-19/0020 Characteristic load-bearing capacity in kN, wood strength class 350 kg/m<sup>3</sup> char. Gross density. The minimum distances between the connectors and the edges according to ECS must be complied with.

Please note: Verify the assumptions made. The stated values, and type and number of joining devices are based on preliminary measurements. Projects are to be dimensioned exclusively by authorised persons in accordance with the State Building Code. As per LBau0, please contact a qualified structural engineer for a paid proof of stability. We will be happy to refer you to someone.

## Tension strap HH70 – static values



Load direction F1								
Connection Timber-Timber								
Leg connection 1	Panelwister CH Ø 5 x 120 n= 12	Anchor nails Ø 4 x 40 n=8	Anchor nails Ø 4 x 50 n=8	Anchor nails Ø 4 x 60 n=8	Angle-bracket screw Ø 5 x 40 n=8	Angle-bracket screw Ø 5 x 50 n=8	Angle-bracket screw Ø 5 x 60 n=8	Steel S250
Leg connection 2	Panelwister CH Ø 5 x 120 n= 12	Anchor nails Ø 4 x 40 n=8	Anchor nails Ø 4 x 50 n=8	Anchor nails Ø 4 x 60 n=8	Angle-bracket screw Ø 5 x 40 n=8	Angle-bracket screw Ø 5 x 50 n=8	Angle-bracket screw Ø 5 x 60 n=8	Steel S250
Char. tensile capacity [kN]	35	12,5	14,7	15,2	17,1	18,2	19,4	37,4

The load-bearing capacities were determined based on ETA-19/0020 Characteristic load-bearing capacity in kN, wood strength class 350 kg/m<sup>3</sup> char. Gross density. The minimum distances between the connectors and the edges according to ECS must be complied with.

Please note: Verify the assumptions made. The stated values, and type and number of joining devices are based on preliminary measurements. Projects are to be dimensioned exclusively by authorised persons in accordance with the State Building Code. As per LBau0, please contact a qualified structural engineer for a paid proof of stability. We will be happy to refer you to someone.

## Tension strap HB60 – static values



Load direction F1														
Connection Timber-Concrete														
Wood side connection	Panelwister CH Ø 5 x 120 n=9				Anchor nails Ø 4 x 40 n=6				Anchor nails Ø 4 x 50 n=6				Anchor nails Ø 4 x 60 n=6	
Concrete side connection	Rock concrete screws Ø 12,5 x 120 n=1	Rock concrete screws Ø 12,5 x 120 n=2	Bolt anchor Ø 12 x 110 n=1	Bolt anchor Ø 12 x 110 n=2	Rock concrete screws Ø 12,5 x 120 n=1	Rock concrete screws Ø 12,5 x 120 n=2	Bolt anchor Ø 12 x 110 n=1	Bolt anchor Ø 12 x 110 n=2	Rock concrete screws Ø 12,5 x 120 n=1	Rock concrete screws Ø 12,5 x 120 n=2	Bolt anchor Ø 12 x 110 n=1	Bolt anchor Ø 12 x 110 n=2	Rock concrete screws Ø 12,5 x 120 n=1	Rock concrete screws Ø 12,5 x 120 n=2
Char. Shear carrying capacity [kN]	20,8*	20,8*	12,6	20,8*	9,3	9,3	9,3	9,3	11,0	11,0	11,0	11,0	11,4	11,4

Load direction F1														
Connection Timber-Concrete														
Wood side connection	Anchor nails Ø 4 x 60 n=6		Angle-bracket screw Ø 5 x 40 n=6				Angle-bracket screw Ø 5 x 50 n=6				Angle-bracket screw Ø 5 x 60 n=6			
Concrete side connection	Bolt anchor Ø 12 x 110 n=1	Bolt anchor Ø 12 x 110 n=2	Rock concrete screws Ø 12,5 x 120 n=1	Rock concrete screws Ø 12,5 x 120 n=2	Bolt anchor Ø 12 x 110 n=1	Bolt anchor Ø 12 x 110 n=2	Rock concrete screws Ø 12,5 x 120 n=1	Rock concrete screws Ø 12,5 x 120 n=2	Bolt anchor Ø 12 x 110 n=1	Bolt anchor Ø 12 x 110 n=2	Rock concrete screws Ø 12,5 x 120 n=1	Rock concrete screws Ø 12,5 x 120 n=2	Bolt anchor Ø 12 x 110 n=1	Bolt anchor Ø 12 x 110 n=2
Char. Shear carrying capacity [kN]	11,4	11,4	10,9	10,9	10,9	10,9	12,0	12,0	12,0	12,0	13,1	13,1	12,6	13,1

\* Concrete edge breakout for cracked concrete

The load-bearing capacities were determined based on ETA-19/0020 Characteristic load-bearing capacity in kN, wood strength class 350 kg/m<sup>3</sup> char. Gross density. The minimum distances between the connectors and the edges according to EC5 must be complied with.

Please note: Verify the assumptions made. The stated values, and type and number of joining devices are based on preliminary measurements. Projects are to be dimensioned exclusively by authorised persons in accordance with the State Building Code. As per LBauO, please contact a qualified structural engineer for a paid proof of stability. We will be happy to refer you to someone.

## Tension strap HB70 – static values

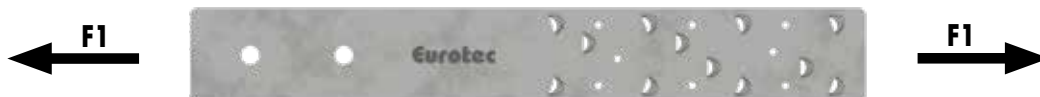

Load direction F1														
Connection Timber-Concrete														
Wood side connection	Panelwister CH Ø 5 x 120 n=12				Anchor nails Ø 4 x 40 n=8				Anchor nails Ø 4 x 50 n=8				Anchor nails Ø 4 x 60 n=8	
Concrete side connection	Rock concrete screws Ø 12,5 x 120 n=1	Rock concrete screws Ø 12,5 x 120 n=2	Bolt anchor Ø 12 x 110 n=1	Bolt anchor Ø 12 x 110 n=2	Rock concrete screws Ø 12,5 x 120 n=1	Rock concrete screws Ø 12,5 x 120 n=2	Bolt anchor Ø 12 x 110 n=1	Bolt anchor Ø 12 x 110 n=2	Rock concrete screws Ø 12,5 x 120 n=1	Rock concrete screws Ø 12,5 x 120 n=2	Bolt anchor Ø 12 x 110 n=1	Bolt anchor Ø 12 x 110 n=2	Rock concrete screws Ø 12,5 x 120 n=1	Rock concrete screws Ø 12,5 x 120 n=2
Char. Shear carrying capacity [kN]	20,8*	20,8*	12,6	20,8*	12,5	12,5	12,5	12,5	14,7	14,7	12,6	14,7	15,2	15,2

Load direction F1														
Connection Timber-Concrete														
Wood side connection	Anchor nails Ø 4 x 60 n=8		Angle-bracket screw Ø 5 x 40 n=8				Angle-bracket screw Ø 5 x 50 n=8				Angle-bracket screw Ø 5 x 60 n=8			
Concrete side connection	Bolt anchor Ø 12 x 110 n=1	Bolt anchor Ø 12 x 110 n=2	Rock concrete screws Ø 12,5 x 120 n=1	Rock concrete screws Ø 12,5 x 120 n=2	Bolt anchor Ø 12 x 110 n=1	Bolt anchor Ø 12 x 110 n=2	Rock concrete screws Ø 12,5 x 120 n=1	Rock concrete screws Ø 12,5 x 120 n=2	Bolt anchor Ø 12 x 110 n=1	Bolt anchor Ø 12 x 110 n=2	Rock concrete screws Ø 12,5 x 120 n=1	Rock concrete screws Ø 12,5 x 120 n=2	Bolt anchor Ø 12 x 110 n=1	Bolt anchor Ø 12 x 110 n=2
Char. Shear carrying capacity [kN]	12,6	15,2	17,2	17,1	12,6	17,1	18,2	18,2	12,6	18,2	19,0	19,0	12,6	19,0

\* Concrete edge breakout for cracked concrete

The load-bearing capacities were determined based on ETA-19/0020 Characteristic load-bearing capacity in kN, wood strength class 350 kg/m<sup>3</sup> char. Gross density. The minimum distances between the connectors and the edges according to EC5 must be complied with.

Please note: Verify the assumptions made. The stated values, and type and number of joining devices are based on preliminary measurements. Projects are to be dimensioned exclusively by authorised persons in accordance with the State Building Code. As per LBauO, please contact a qualified structural engineer for a paid proof of stability. We will be happy to refer you to someone.



**NEW**  
to our product range

# Corner brackets S, M and L



## What can it be used for?

---

- Load-bearing connections for timber construction e.g. large carports, small halls

## Advantages

---

- Supports load absorption with horizontal forces
- Pre-assembly at the factory optional
- Visible (surface-mounted) and hidden (flush-mounted) joints
- Many different areas of use

## Assembly

---

- Quick and easy installation

## Corner brackets S, M and L

Art. no.	Product name	Dimensions [mm]	Material thickness [mm]	Column [mm]	Frame [mm]	PU
975673	Corner bracket S	230 x 110	15	140 x 140	140 x 320	1
975674	Corner bracket M	250 x 120	15	160 x 160	160 x 360	1
975675	Corner bracket L	330 x 120	15	160 x 240	160 x 400	1



Suitable for this:  
Magnus, IdeeFix, KonstruX

### Description

The Eurotec corner brackets S, M, and L enable the simple construction of a rigid frame corner. Combined with our innovative Magnus or IdeeFix the connection becomes strong. These applications can be found in modern timber construction, especially where the timber construction is a visible aspect. It is possible to avoid further annoying head straps.

### Advantages

- Supports load absorption with horizontal forces
- Pre-assembly at the factory optional
- Visible (surface-mounted) and hidden (flush-mounted) joints
- Many different areas of use

### Instructions for use

After fixing with Magnus or IdeeFix, the corner bracket is assembled. It can be embedded or surface mounted. When assembling the frame corner, the corner bracket can be mounted on one side as an assembly aid. The other KonstruX screws can then be screwed in.





# T-profile

For hidden aluminium connections

## T-profile

Suitable for the EST dowel bar



Art. no.	Dimensions [mm] <sup>a)</sup>	Material	Material thickness [mm]	PU
975652	115 x 80 x 2000	Aluminium	6	1

a) Height x width x profile length



### Application

1. No need for pre-drilling with the self-drilling EST rod dowel (Ø 7,5)
2. Hole pattern for the 5,0 x 50 mm angle-bracket screw
3. The rock concrete screw (Ø 7,5) for joining wood/concrete can be used in service classes 1 and 2 according to DIN EN 1995

### Description

Eurotec's T-profile is a hidden aluminium wood connector for use in service classes 1 and 2. Suitable in terms of geometry for right-angled and inclined connections of individual beams in wood / wood and wood/concrete applications.

Can be combined with our rod dowel, which is screwed in through the T-profile as part of a self-drilling process.

## Technical drawing

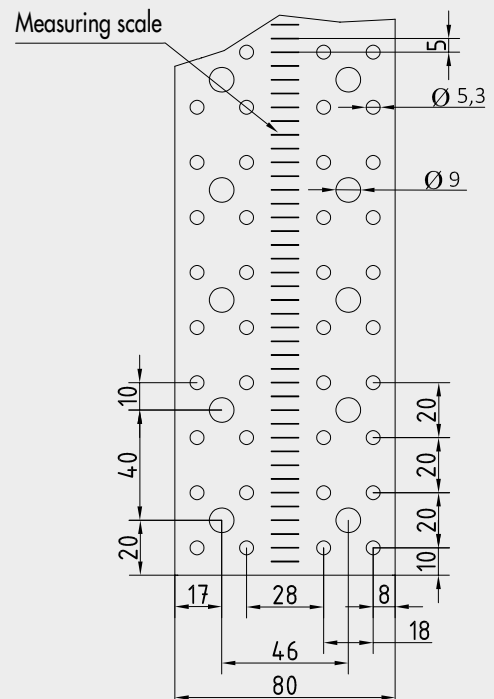
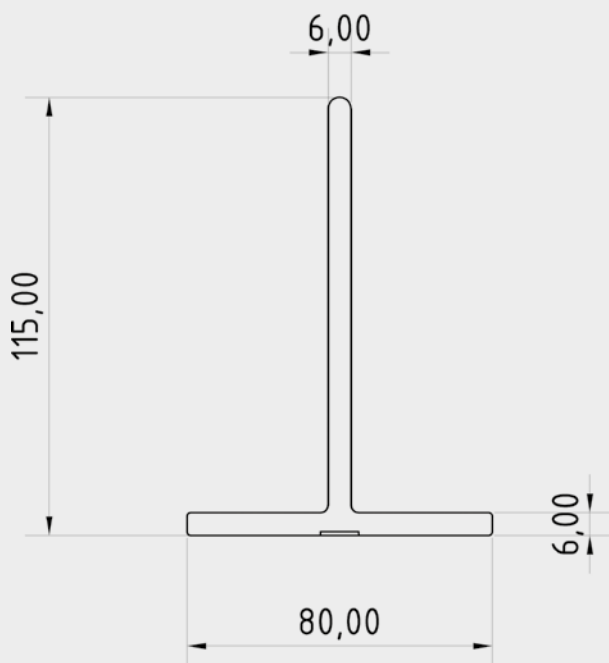

# EST dowel bar

Double-threaded screw with cylinder head



**EST dowel bar**

**Suitable for T-Profile**



Art. no.	Dimensions [mm]	Thread length [mm]	Drive	PU
800304	7,5 x 73	27/0	TX40 ●	50
800291	7,5 x 93	27/8,5	TX40 ●	50
800305	7,5 x 113	36/12,5	TX40 ●	50
800306	7,5 x 133	36/12,5	TX40 ●	50
800307	7,5 x 153	36/12,5	TX40 ●	50
800287	7,5 x 173	36/12,5	TX40 ●	50
800288	7,5 x 193	36/12,5	TX40 ●	50
800289	7,5 x 213	36/12,5	TX40 ●	50
800290	7,5 x 233	36/12,5	TX40 ●	50

### Advantages/properties

- Corrosion resistance
- Can be used in service classes 1 and 2 according to DIN EN 1991
- Good resistance to mechanical stresses
- No pilot-drilling necessary
- With innovative arrow drill
- No hammering of the screws thanks to TX-drive
- Optimum chip-removing groove in the thread
- Suitable for wood and aluminum

### Description

Eurotec's self-drilling EST dowel bar is a double-threaded screw with an innovative arrow drill and a specifically developed chip-removing groove. Ideally suited for hidden connections in combination with our T-profile.

The double-threaded screw has a cylinder head with TX drive. The special geometry of the arrow drill ensures a lower splitting effect when screwing in. The chip-removing groove ensures optimised screwing-in behaviour.

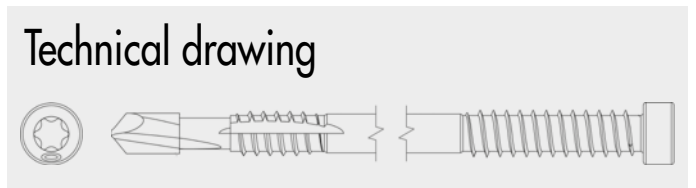

Application combination: EST dowel bar and T-profile



Application combination: EST dowel bar and T-profile





# Dowel bar

## Dowel bar



### Advantages

- Easy to use
- Can be combined with the Eurotec T-profile and all common T-profiles
- Service classes 1 and 2

### Instructions for use

During use, ensure that the distances from the axis and edge are observed. A drilling template must be used for the holes.

### Description

The rod dowel is a cylindrical bolt that has a phase at both ends for easier insertion. The rod dowel is suitable for both wood/wood joints and wood/steel joints. It is ideal for combination with our T-profile. The rod dowel is available in different diameters and lengths for an extremely wide range of applications. Please note the product table for this purpose.

Art. no.	Dimensions [mm]	PU
800212	12 x 98	100
800213	12 x 118	100
800214	12 x 138	100
800215	12 x 158	100
800216	12 x 178	100
800217	12 x 198	100
800218	12 x 218	100
800219	12 x 238	100
800220	12 x 258	100
800221	12 x 278	100
800222	12 x 298	100
800223	16 x 138	50
800224	16 x 158	50
800225	16 x 178	50
800226	16 x 198	50
800227	16 x 218	50
800228	16 x 238	50
800229	16 x 258	50
800230	16 x 278	50
800231	16 x 298	50
800241	16 x 340	50
800243	16 x 480	25
800232	16 x 500	25
800242	16 x 580	25
800233	20 x 158	25
800234	20 x 178	25
800235	20 x 198	25
800236	20 x 218	25
800237	20 x 238	25
800238	20 x 258	25
800239	20 x 278	25
800240	20 x 298	25

## Technical drawing

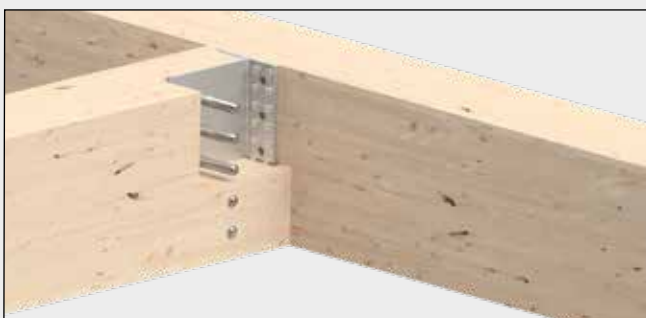
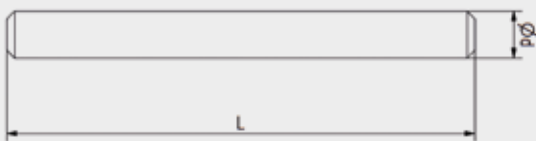

# Mounting connector

For connecting two timber construction elements in systems building

## Mounting connector

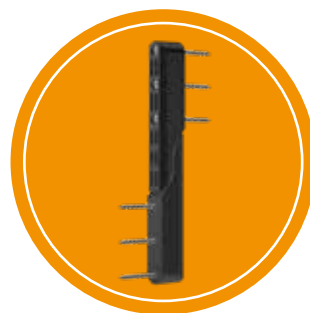

Art. no.	Dimensions [mm] <sup>a)</sup>	PU*
800272	32,7 x 175 x 29,7	50
a) Height x length x width		
* Incl. 150 screws per PU		

### Advantages

- Can be used regardless of weather conditions
- Easy assembly
- Quick and easy element positioning

### Instructions for use

We recommend using our blue Paneltwistec AG CH 6 x 80 mm screws to install the mounting connector. The mounting connector must have a screw inserted in every screw hole. Our mounting connector is designed purely for guidance purposes. It cannot be used to absorb forces.

### Description

The Eurotec mounting connector consists of two interlocking parts and is used as a supportive and preparatory element in systems building for connecting two timber construction elements. It is flush-mounted in a groove positioned at any chosen location on the construction elements. Once the elements have been inserted, the mounting is hidden inside the wall.



# Façadeclip

For hidden fastening of façade wood

## Façadeclip

Black, electrogalvanised



### Advantages

- For façade timbers with a profile height of 57–95 mm
- Hidden fastening
- Perfect constructive timber protection
- Ventilated façade system with spaced installation
- The façade timber's surface that is exposed to the weather remains undamaged
- Efficient and easy installation



Art. no.	Dimensions [mm] <sup>a)</sup>	Type	PU*
946010	5,5 x 115 x 15	F115 x 17	300
946012	5,5 x 115 x 15	F115 x 22	300
946013	5,5 x 115 x 15	F115 x 28	300
946014	5,5 x 130 x 15	F130 x 17	300
946015	5,5 x 130 x 15	F130 x 22	300
946016	5,5 x 130 x 15	F130 x 28	300
946017	5,5 x 145 x 15	F145 x 17	300
946018	5,5 x 145 x 15	F145 x 22	300
946019	5,5 x 145 x 15	F145 x 28	300

a) Height x length x width

\* Screws are included with this product

## Technical data

Eurotec Façadeclip		Dimensions façade profile			Joint clearance between façade profiles		Quantity required Façade clips per m <sup>2</sup> Example				
Dimensions [mm]		min.-max. height	min. strength	Assembly screw Length (L)	Fixing screw in hole A	Fixing screw in hole B	min. profile height	max. profile height			
Art. no.	Type	H	W	L	[mm]	[mm]	[mm]	[mm]	Stück	Stück	
946010	F115 x 17	5,5	115	15	57 - 68	19	17	10	variable	28	24
946012	F115 x 22	5,5	115	15	57 - 68	24	22	10	variable	28	24
946013	F115 x 28	5,5	115	15	57 - 68	30	28	10	variable	28	24
946014	F130 x 17	5,5	130	15	68 - 80	19	17	10	variable	24	20
946015	F130 x 22	5,5	130	15	68 - 80	24	22	10	variable	24	20
946016	F130 x 28	5,5	130	15	68 - 80	30	28	10	variable	24	20
946017	F145 x 17	5,5	145	15	80 - 95	19	17	10	variable	20	18
946018	F145 x 22	5,5	145	15	80 - 95	24	22	10	variable	20	18
946019	F145 x 28	5,5	145	15	80 - 95	30	28	10	variable	20	18

Fastened to substructure with 4,5 x 29 mm fixing screw with drill point

Formula for determining quantity  
 $(1000 \text{ mm}/\text{substructure distance}) \times (1000 \text{ mm}/\text{bottom edge clearance}) = \text{pieces}/\text{m}^2$

600 mm substructure clearance  
 10 mm joint clearance

Please note: Before any work is carried out, all calculations must be checked and released by the responsible planner! For more information on this visit our homepage: [www.eurotec.team/en](http://www.eurotec.team/en)

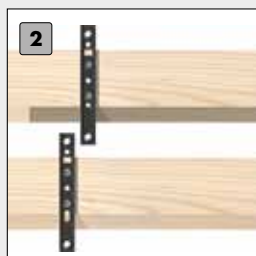
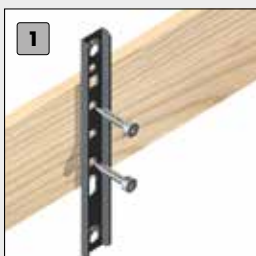

## Efficient and easy installation

- 1 Place Façadeclip on the back with stopper and insert assembly screws
- 2 Repeat on all façade boards displaced
- 3 FScrew the façade wood to the counter-lathe with fixing screw
- 4 Simply insert the next façade wood and screw on the top only with fixing screw
- 5 The joint clearance is set automatically by the screw head of the fixing screw, that's it!

Each Façadeclip comes supplied with one 4,5 x 29 mm fixing screw with a drill point and two 4,2 x L assembly screws.

Hole A

Hole B

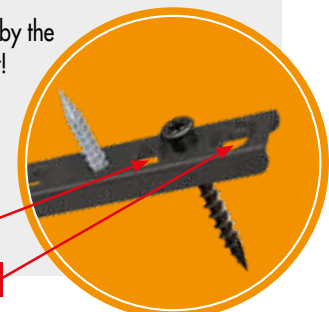

# Façadeclip for Rhombus profiles

For use with the most common façade profiles

## Façadeclip for Rhombus profiles

System consisting of a Façadeclip Rhombus Starter and a Façadeclip Rhombus



Façadeclip Rhombus



Façadeclip Rhombus Starter

### Advantages

- Optimised rear ventilation by constructive timber protection - Exclusive to Eurotec!
- Invisible fastening
- Formation of fixed points and sliding points
- Easy installation
- Weather-resistant

### Properties

Using the clip creates a joint dimension of 6 mm. The clip was designed so that it does not rest flat on the substructure, instead it elevates the boards by 4mm from the substructure. The constructional wood protection allows for rear ventilation of the façade, which is not the case with any of the usual products. Rear ventilation results in better drying when the façade is exposed to rain, and water can run off between the clip and substructure. The constructional measures increase the façade's service life.

## Properties Rhombus Profiles

- Dimensional stability must be provided for wood
- Low to moderate gross density
- Low swelling and shrinkage
- Suitable for wood that is low in tannin

### Coniferous woods\*



### Thermally modified timber\*

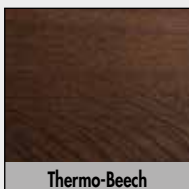

\* Other wood can also be used, but please ask your wood supplier.

Art. no.	Description	Dimensions [mm] <sup>a)</sup>	Material	PU*
944917-50	Façadeclip Rhombus	15,20 x 54,5 x 29,5	Galvanised steel	50
944917-200	Façadeclip Rhombus	15,20 x 54,5 x 29,5	Galvanised steel	200
944918	Façadeclip Rhombus Starter	15,25 x 29,5 x 36,0	Galvanised steel	25

a) Height x length x width  
\* Incl. screws

## Technical data:

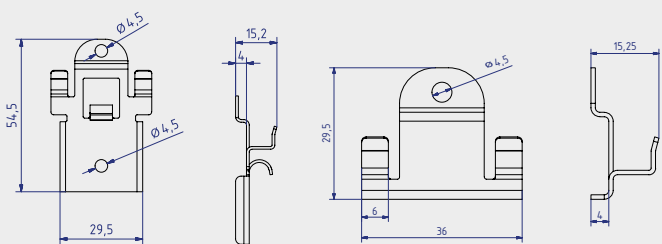

Façadeclip Rhombus

Façadeclip Rhombus Starter

## Profile

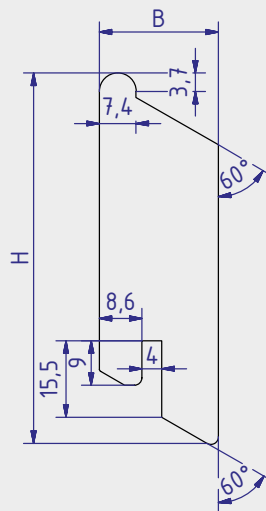

## Wall-connection



## Detail A



In the case of vertical installation, the following points must be observed when using the Façadeclip Rhombus Starter. We recommend making a 15° undercut for forming a drip edge in the rhombus profile. The Façadeclip Rhombus Starter fits perfectly with a 4 mm wide groove slit in the wood profile (see detail A).

Dimensions		
Variants	Height H [mm]	Width W [mm]
Variants 1	70	21
Variants 2	75	24



## Installation instructions: Horizontal fixing

- 1** The Façadecлип Rhombus Starter must be attached to the lower end of the façade. Can be fixed and aligned with the enclosed screw. This is done over the entire length of the façade.

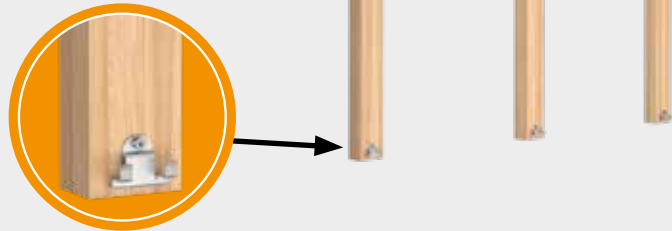

- 2** The first board can be placed on the pre-fixed Façadeclips Rhombus Starter. Through the fixation to the substructure, the profile lays securely on to the pre-assembled clips.

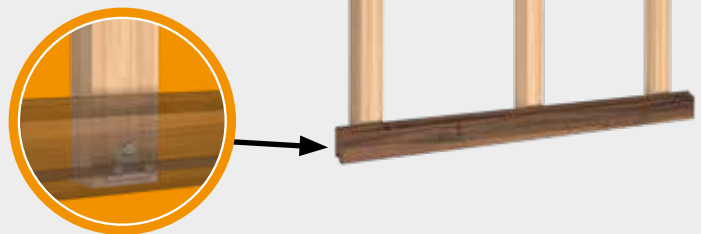

- 3** It is recommended to install the first Façadecлип Rhombus in the middle of the first profile. This will give the first profile a better hold.



- 4** The remaining Façadeclips Rhombus can be mounted along the profile. For this purpose they are pushed between the plank and the substructure and fixed with the enclosed screw. The screws of all clips must be sufficiently tightened.

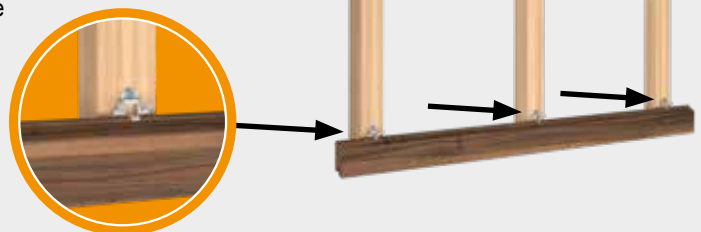

- 5** In this step the next plank is inserted. From here, steps **3 and 4** are repeated until the façade is completely closed.

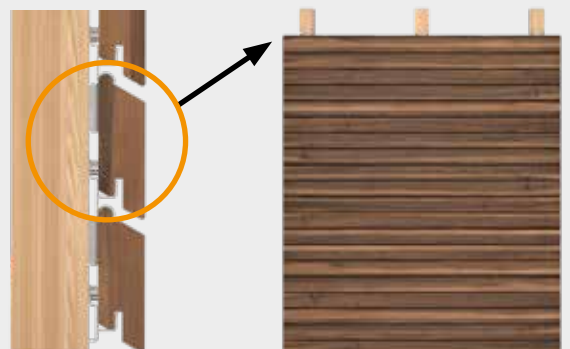

For areas where windows, doors, floorboard joints or the end of the façade is/are located, fixed points can be formed thanks to the prefabricated hole in the Façadeclips Rhombus. To achieve this, the clip is firstly screwed down on the rear of the profile. The clip can then be screwed to the substructure.

## Installation instructions: Vertical fixing

- 1** The Façadeclip Rhombus Starter must be fixed and aligned at the first substructure joist of the façade with the enclosed screw. This is done over the entire length of the façade. The specified dimensions of the profile to be installed must be taken into account.

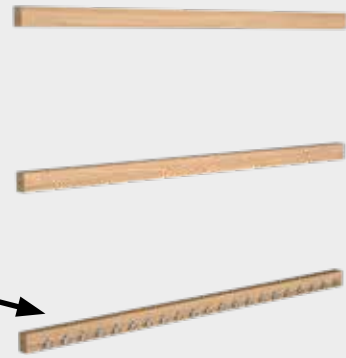

- 2** Façadeclips Rhombus Starter must also be installed to the end of each further substructure joist (right or left). These must be aligned along the substructure.

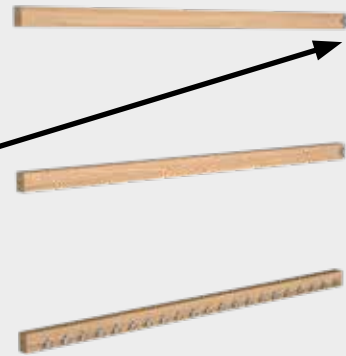

- 3** A slot has to be milled at the end of each board. This is placed on the first pre-assembled Façadeclip Rhombus Starter. Due to the laterally attached Façadeclips Rhombus Starter, the profile should already have a certain fixation on the wall. In order to optimise this, it is advisable to mount a Façadeclip Rhombus on one of the middle substructure profiles.

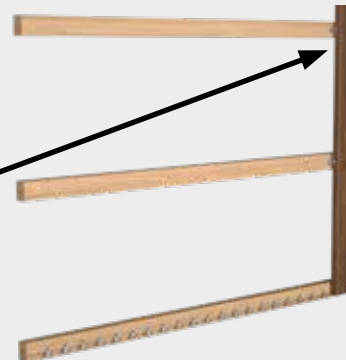
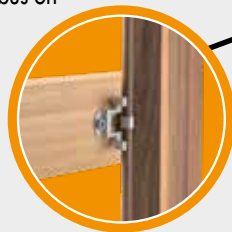

- 4** The remaining Façadeclips Rhombus can be mounted along the profile. Place the clips between the board and the substructure joist and fix them with the enclosed screw. The screws of all clips must be sufficiently tightened. The information provided as in the remark applies to fixed points in the event of horizontal installation.

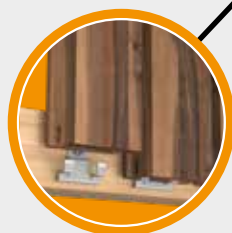

The function can only be guaranteed when the specifications are complied with.

# Façade fixing screw ZK

For the non-visible attachment of rhombus profiles

## Façade fixing screw ZK

Ornamental head, hardened stainless steel

Stainless Steel



### Advantages

- Non-visible attachment
- Milling ribs enable easy countersinking for all types of wood
- Short thread for compact bolting to the substructure and the rhombus profile
- Corrosion/resistant up to and including service class 3 - "freely exposed constructions" according to DIN EN 1995 (Eurocode 5)

### Application information

The particular screw geometry decreases the risk of splitting the wood. Pre-drilling, however, is strongly recommended, in particular for hardwoods used for the façade construction!

Art. no.	Dimensions [mm]	Drive	PU
905577	5,5 x 40	TX25 •	200
905578	5,5 x 45	TX25 •	200
905579	5,5 x 50	TX25 •	200
905580	5,5 x 55	TX25 •	200
905581	5,5 x 60	TX25 •	200
905582	5,5 x 70	TX25 •	200
905583	5,5 x 80	TX25 •	200
905585	5,5 x 90	TX25 •	200
905584	5,5 x 100	TX25 •	200

## Assembly instructions for horizontal profile arrangement

**1** Uniformly position the rhombus profiles.

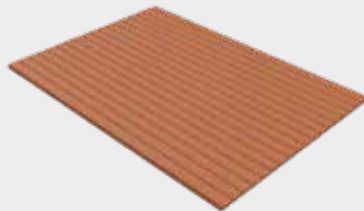

**2** Uniformly position the substructure at right angles to the rhombus profiles.



**3** Bolt the lowest rhombus profile to the substructure using the ZK façade screws.

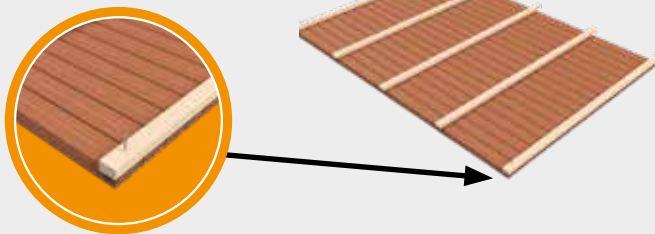

### Profile

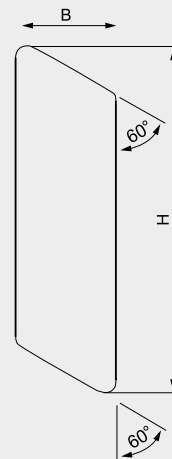

### Wall-connection



**4** Inspect the spacing to the next rhombus profile, bolt the profile to the substructure and repeat **step 4** until all profiles are fastened.

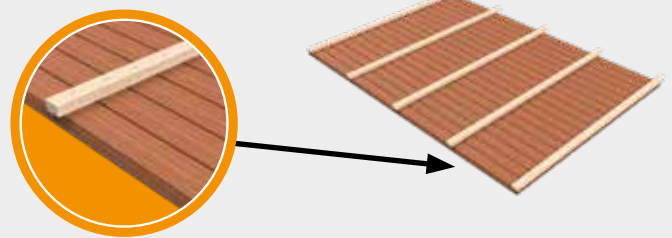

**5** Install the wall element and mount it to the wall.

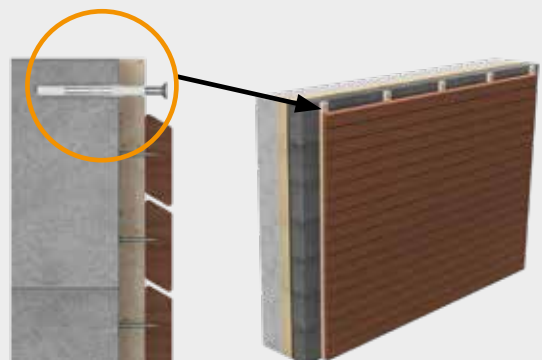

# EPDM façade tape

## EPDM façade tape



Suitable for



### Especially suited to

- Hapatec Heli Stainless Steel A4
- Terrasotec hardened stainless steel
- Hobotec ornamental head
- Hobotec screw
- Paneltwistec Stainless Steel A4

### Properties

The EPDM façade tape protects the timbers of your façade substructure against moisture and thus aids constructive timber protection. It is tear-proof, durable and easy to fasten thanks to an adhesive film. The façade tape is supplied as a roll and can be cut to length individually.

Art. no.	Dimensions [mm] <sup>a)</sup>	PU
954041	8 x 9750 x 10	10

a) Height x length x width





# Silent EPDM decoupling profile

For sound insulation and material separation

## Silent EPDM decoupling profile

Art. no.	Dimensions [mm] <sup>a)</sup>	PU
945382	95 x 20000 x 5	1

a) Height x length x width



### Advantages

- Versatile applications
- Can be individually cut to size (supplied as a roll)
- Ageing-resistant
- UV-stable
- Ozone-resistant
- Free of conflict materials

### Properties

- Density: approx. 1,4 g/cm<sup>3</sup>
- Usage temperature: -30°C - +90°C
- Shore hardness 48 = 0,500 N/mm<sup>2</sup> = 0,05 kN/cm<sup>2</sup> = 500 kN/m<sup>2</sup>

### Instructions for use

Cut the decoupling profile to the desired length and place it in the chosen position, then fasten it in place at intervals of approx. 40–60 cm, for example using the Eurotec Hammer tacker.

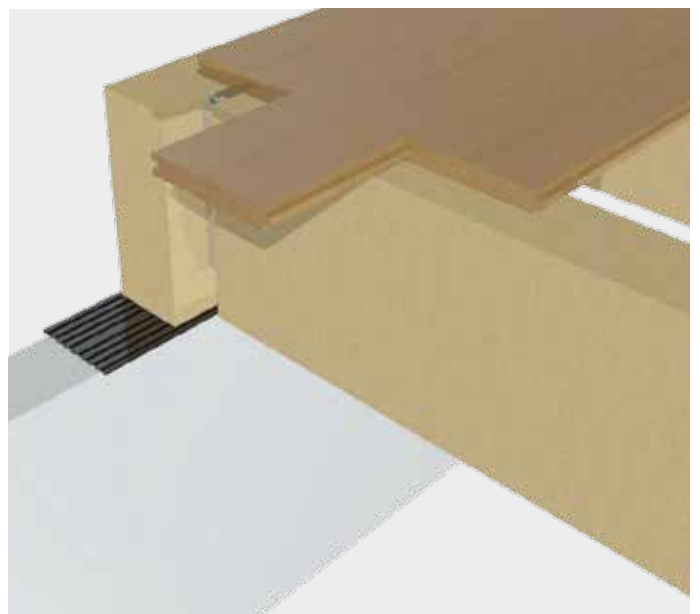

# SonoTec, sound insulation cork

The perfect solution for sound insulation

## Technical advantages

- Sustainable material
- High load bearing capacity
- Hidden installation
- Easy to use
- Impermeable to water and gas due to component-specific requirements

## Product properties

- Material  
The SonoTec soundproof cork is a combination of the components cork and natural rubber. This product is suitable for the application of vibration damping where very high isolation values are required and can be used as invisible insulators (pads/strips) with a low resonant frequency and medium to low load.
- Load absorption  
Different loads have to be absorbed when decoupling the timber vertical truss from the concrete. These are located in the  $0,1 \text{ N/mm}^2 - 3 \text{ N/mm}^2$  stat. permanent load range. A timber beam (C24 softwood) may only be loaded up to  $2,5 \text{ N/mm}^2$  (characteristic) perpendicular to the grain. Our products cover load cases from  $0,1 \text{ N/mm}^2 - 3 \text{ N/mm}^2$  ab. The cork can thus be used both in lightweight and solid construction with cross-laminated timber (CLT).
- Noise reduction  
The SonoTec sound insulation cork can reduce noise by up to 40 dB.



## SonoTec, sound insulation cork

Material: SK02

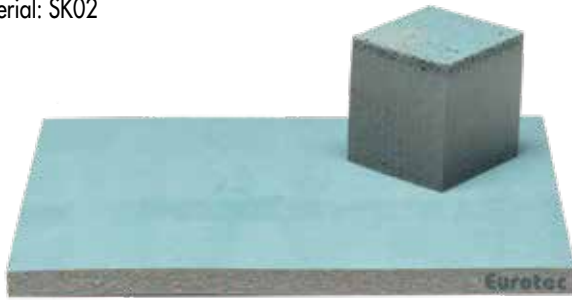

Art. no.	Name	Dimensions [mm]	Material thickness [mm]	PU
945305	SK02	80 x 1100	6	20
945306	SK02	100 x 1100	6	20

## SonoTec, sound insulation cork

Material: SK03

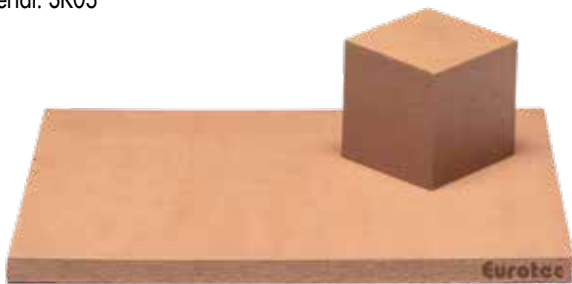

Art. no.	Name	Dimensions [mm]	Material thickness [mm]	PU
945307	SK03	80 x 1100	6	20
945308	SK03	100 x 1100	6	20

## SonoTec, sound insulation cork

Material: SK04

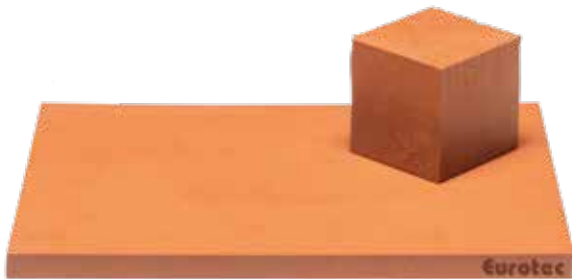

Art. no.	Name	Dimensions [mm]	Material thickness [mm]	PU
945309	SK04	80 x 1100	6	20
945310	SK04	100 x 1100	6	20

## Technical data

	SK02	SK03	SK04
	Load ranges [N/mm <sup>2</sup> ]		
Temperature [C°] / span width	10/+100	-10/+100	-10/+100
Density [kg/m <sup>3</sup> ]	700	1100	1125
Shore hardness [shore A]	35 - 50	45 - 60	60 - 80
Break rotatio [%]	> 200	> 300	> 100
Tensile strength [N/mm <sup>2</sup> ]	> 2,0	> 5,0	> 6,0
23°C / 70 h compression [%]	< 15	< 15	< 15



## Identifying the correct material: an example

We precisely identify the right material for you. So you still get an idea of how the right material is identified, we have outlined a sample identification process for you below.

**First of all**, we need the static continuous load that the sound insulation cork is to absorb. This is specified by the architect, structural engineer or stress analyst in question.

One of three different materials is selected depending on the static continuous load:

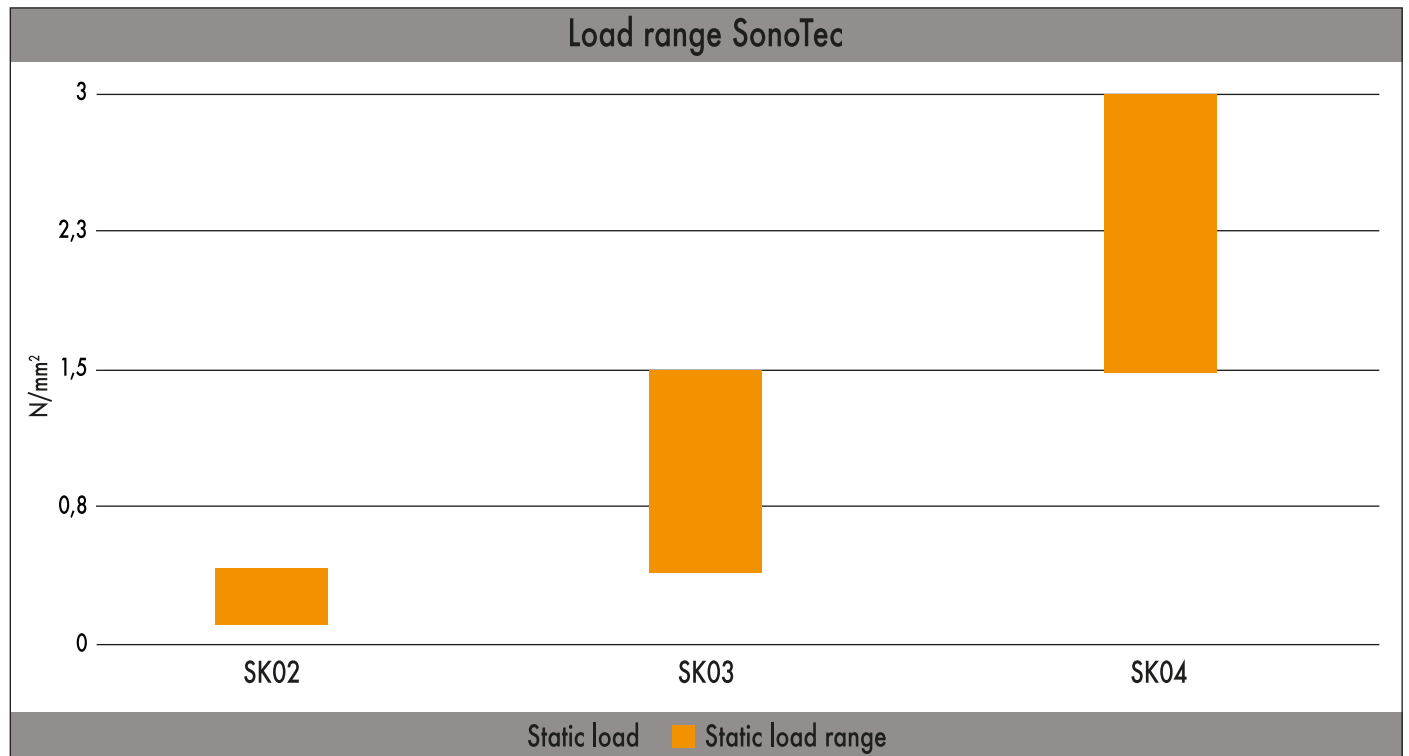



Static continuous load N/mm <sup>2</sup>	Product	Dimensions [mm]	Art. no.
0,10 - 0,39	SK02	80 x 1100	945305
0,10 - 0,39	SK02	100 x 1100	945306
0,40 - 1,40	SK03	80 x 1100	945307
0,40 - 1,40	SK03	100 x 1100	945308
1,50 - 3,10	SK04	80 x 1100	945309
1,50 - 3,10	SK04	100 x 1100	945310

In the **second step**, the material's natural frequency is determined; this depends on the occurring load. The values are approximately taken from the following table.

	Load [N/mm <sup>2</sup> ]	6 mm			12 mm		
		Natural frequency [Hz]	Deflection [mm]	Modulus of elasticity @10 Hz	Natural frequency [Hz]	Deflection [mm]	Modulus of elasticity @10 Hz
SK02	0,1	44	0,2	4,0	27	0,5	3,7
	0,2	33	0,5	4,5	19	1,3	4,0
	0,3	27	0,8	5,6	17	1,9	5,1
	0,4	27	1,1	6,9	17	2,6	6,5
SK03	0,5	50	0,2	11,5	31	0,4	10,5
	0,8	38	0,4	15,75	22	1,0	14,0
	1,1	31	0,7	19,5	20	1,6	18,0
SK04	1,5	31	0,9	28,5	20	2,2	27,0
	1,6	58	0,3	18,5	36	0,6	17,0
	2,4	44	0,6	24,5	25	1,3	22,0
	3,2	35	1,0	30,5	23	2,0	28,0
	4,0	35	1,5	43,0	23	2,7	41,0

\*Values for SK02 are based on test results provided by the University of Coimbra / Institute for Research and Technological Development in Construction Sciences. The values for SK03 and SK04 are generalised. The ongoing tests confirm the values. The results will replace the described values.

As an example, the following sample calculation assumes a load of 0,3 N/mm<sup>2</sup>. Our **SK02** material was chosen due to the specified load. From the above table, we can see that the natural frequency must therefore be 27 Hz. We can illustrate this as follows in the graphs below.

### SK02 Natural frequency [Hz]

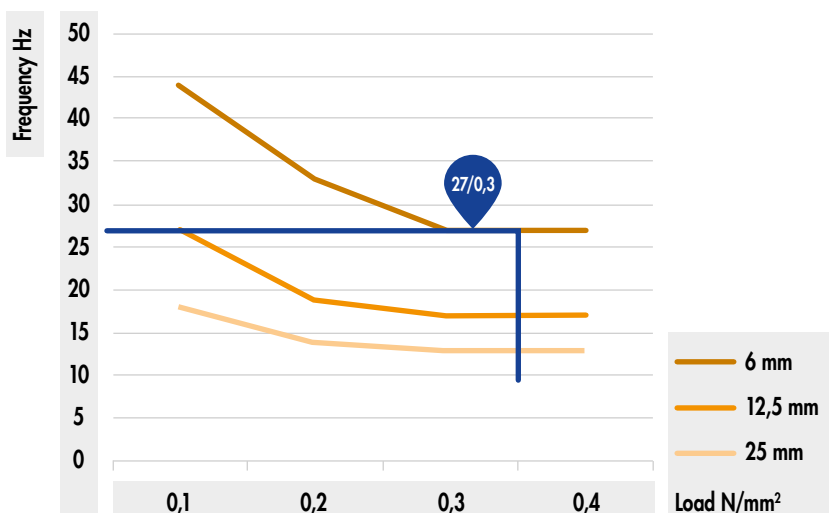

**In the next step**, we take a closer look at the interference frequency. To this end, we look at the graphs below and can thus conclude that the sound reduction in the low frequency range has deteriorated. Low frequencies (basses) can only be isolated by mass. The frequencies to be isolated for building acoustics start in the 80 Hz range, so this is negligible. 80 Hz can be assumed if no interference frequencies are specified.

The sound reduction in dB can be determined in two ways:

1:

Based on an interference frequency of 80 Hz, a sound reduction of approx. 17 dB can be read off the following graph. These values are achieved under ideal conditions (optimum room temperature, room humidity, etc.).

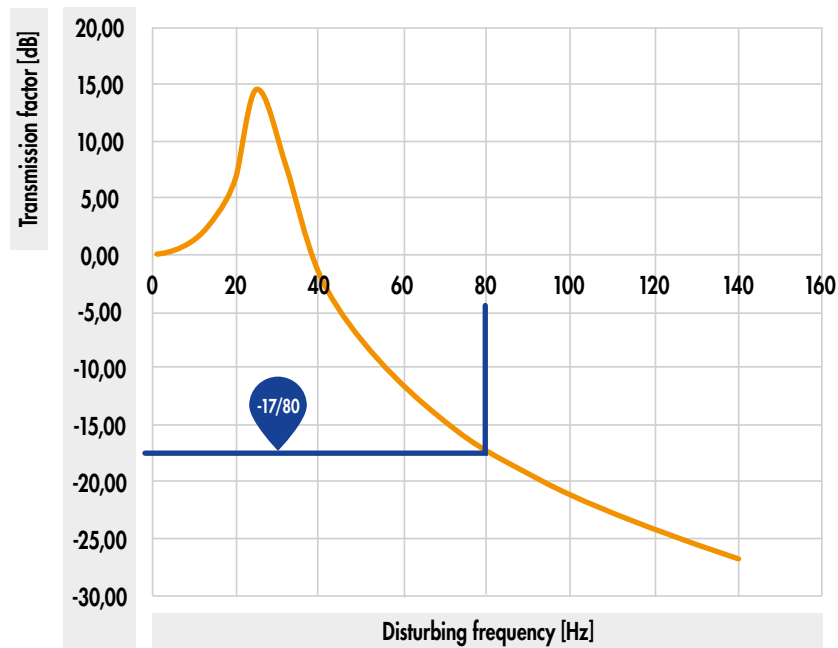

2:

A sound insulation factor can be calculated from the natural frequency identified previously (27 Hz) and the specified interference frequency (80 Hz).

**Sound insulation factor  $f/f_0$ :** Interference frequency / natural frequency  
 $\rightarrow 80 \text{ Hz} / 27 \text{ Hz} \approx 2,96$

The sound reduction can then be read off based on the factor calculated previously. This is 17 dB under ideal conditions.

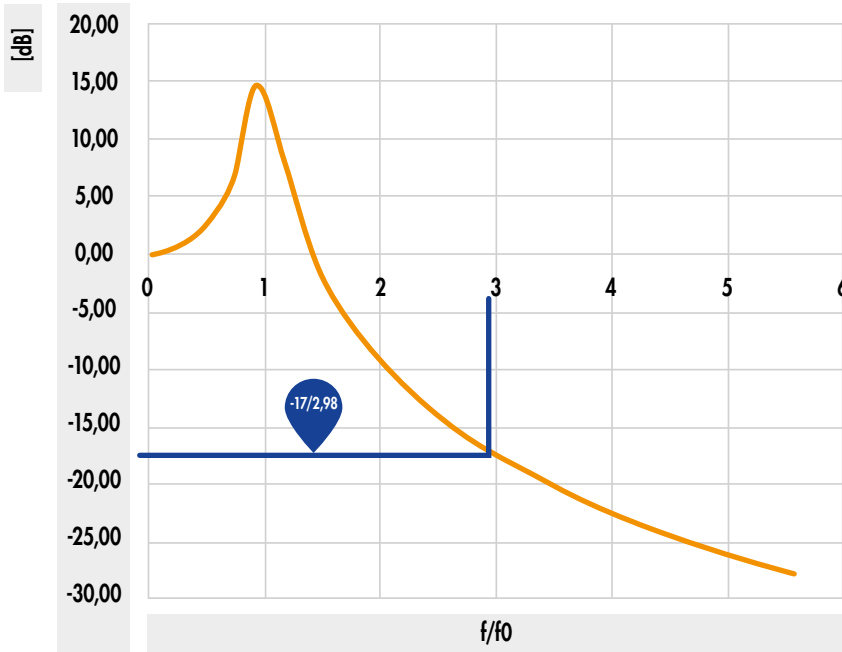

In the last step, the material's deflection is identified. This step is particularly important for the building's designers. The deflection is also identified using the continuous load, and there is a separate graph for each material. For the sample calculation with SK02 and 0,3 N/mm<sup>2</sup>, the following graph shows a deflection of 0,8 mm.

The graphs shown here are naturally adapted to the factors identified previously.

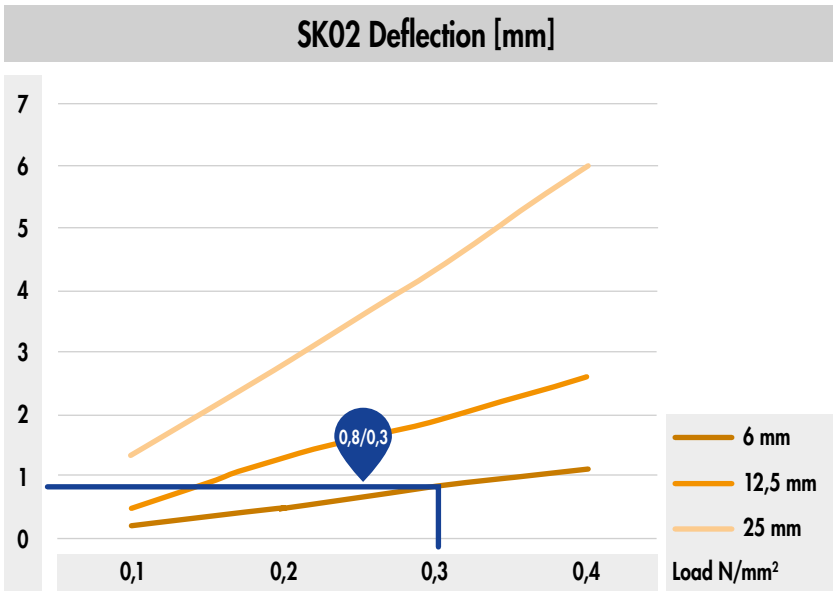

For our SK03 and SK04 materials, the following graphs apply to the deflection:

### SK03 Deflection [mm]

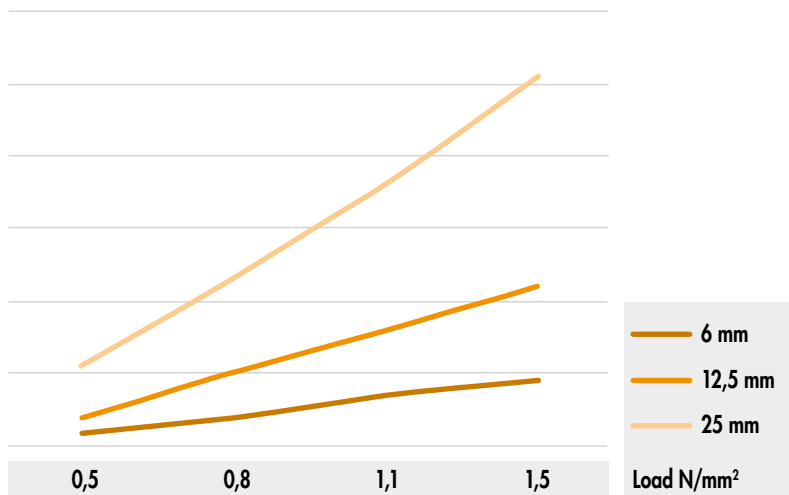

### SK04 Deflection [mm]

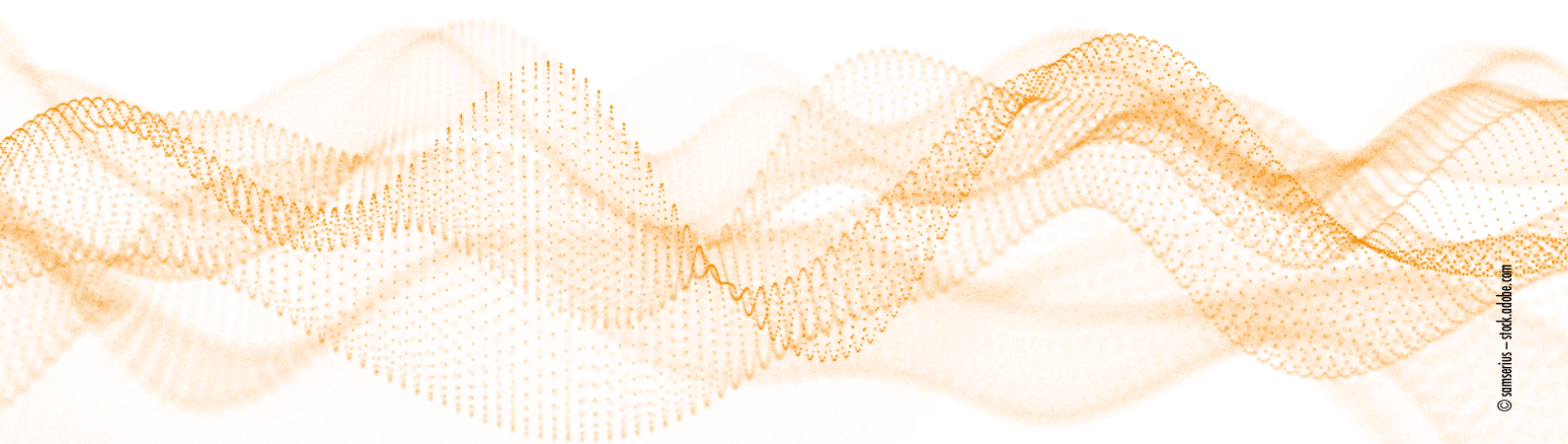
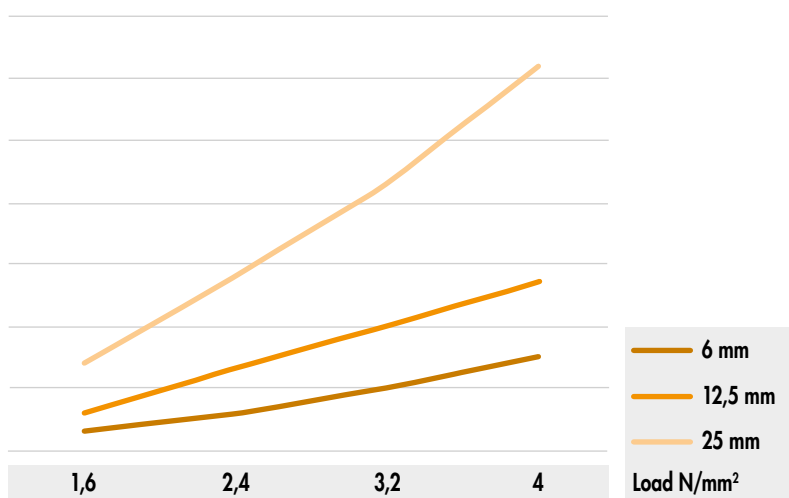



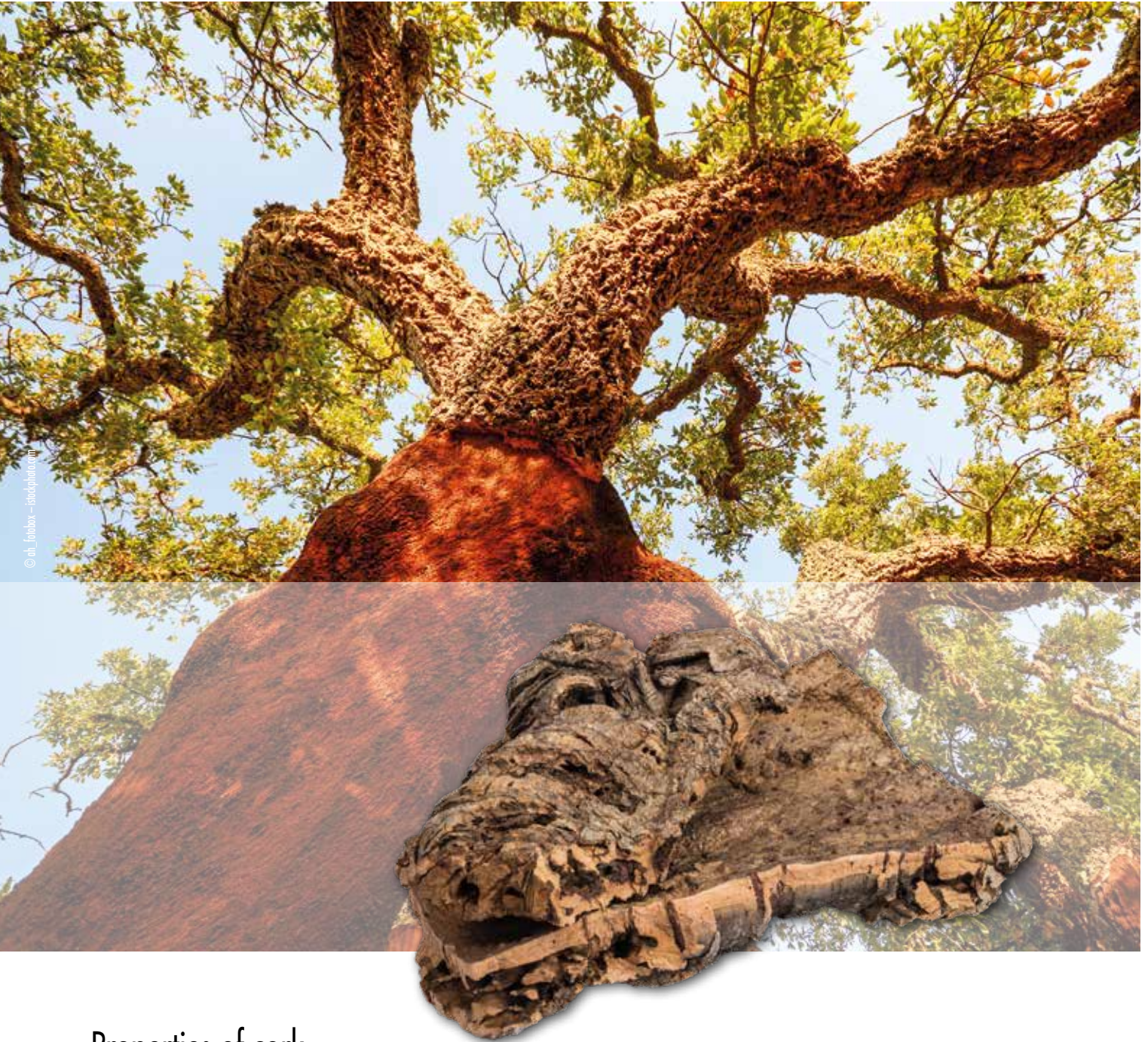

## Properties of cork

The cork bark has a honeycomb-shaped cell structure with over 40 million cells per  $\text{cm}^3$ . The cells have a high proportion of an air-like gas mixture, which results in the cork's low weight on the one hand and the high compression capacity and elasticity on the other. The cork can therefore be compressed by up to half its size and can return to its original shape after compression.

Almost half of the cork bark is made up of suberin, a non-combustible biopolymer. The substance lines the individual cells and makes them impermeable to liquids and gases. The bark's structure and thickness protect the cork oak from heat, drying out and infections. This natural protective insulation makes cork oak an ideal insulating and sealing material for technical purposes.

## Advantages

- Very good sound and thermal insulation
- Impermeable to liquids and gases
- Good resistance to fire and high temperatures
- High frictional resistance
- Compressible and elastic
- Good wear resistance
- Low weight – floats on water
- Hypoallergenic and anti-static – does not absorb dust
- High flexibility – comfortable and soft



## Environment

Cork is one of the most natural and environmentally friendly raw materials in the world. Cork oak is also the only tree that can completely regenerate itself after each harvest. The fact that cork can be recycled and reused in new products makes it an ideal raw material with regard to sustainability.

## Natural rubber

Alongside cork, natural rubber is another natural and renewable raw material. Natural rubber is a rubber-like substance and is extracted from the milky sap (also known as latex) of the rubber tree. The rubber tree grows in the tropics of Africa, South America and Asia. Natural rubber accounts for around 40% of global rubber production. In contrast, synthetic rubber is made using crude oil as a basis and consumes far more energy during the manufacturing and transport processes.

Natural rubber is made into various products, most of them are used in tyre production. Other applications include seals, binders and mattresses.

## Properties of natural rubber

- High level of elasticity
- Good mechanical resistance
- High tear strength
- Water repellent
- Poor electrical and thermal performance
- Weighs less than water

*If you would like further information, we would be delighted to send you our brochure. Alternatively, you will find out more online.*



# SonoTec Angular Decoupler

The perfect complement to the Eurotec Shearing Angles and the CLT System Angle

## SonoTec Angular Decoupler



The Eurotec SonoTec Angular Decoupler forms the perfect complement to the Eurotec Shearing Angles and the CLT System Angle. The underlay is made from SK04, which is a compound formed from cork and natural rubber. The product is suitable for vibration damping applications in which very high insulation values are required. SonoTec angular decouplers are used as invisible insulators (pads/strips) with a low resonance frequency and a medium-low load.

### Advantages

- Underlay enables straightforward assembly
- Sustainable material
- Invisible
- High load capacity
- REACH-compliant

### Instructions for use

SonoTec angular decouplers feature cut-outs for concrete screws, making them suitable for use in concrete. The double layer allows an increase in the separation layer to 12 mm. The specifications for SonoTec SK04 Sound Insulation Cork apply. The material can be screwed through when used in wood. The application must be determined in advance by a structural engineer. No statement can be made regarding noise reduction since this is dependent on the construction.

Art. no.	Dimensions [mm]	Material	Suitable for		PU
			Art. no.	Name	
945311	230 x 70 x 6	SK04	954088	HH flat shearing angle	5
945312	230 x 80 x 6	SK04	954180	CLT system angle	5
945314	230 x 100 x 6	SK04	954087	HB flat shearing angle	5
945313	230 x 120 x 6	SK04	954112	Shearing angle 120 x 230	5









## Wood construction screws

ProPack, Paneltwistec AG	280 - 290
SawTec	291 - 294
Paneltwistec blue and yellow galvanised	295 - 304
Screws in magazine	305 - 309
Topduo Roofing screw	310 - 312
Paneltwistec stainless steel and Paneltwistec AG stainless steel	313
Paneltwistec A2/A4	314 - 316
OSB Fix	316
Washer	316
Hobotec screw	317
EcoTec and EcoTec A2	318 - 319
LBS construction screw	320 - 321
ECO PT and Angle-bracket screw	322 - 324
Paneltwistec slate screw and Wing-tipped drilling screw	325
Spacer screw-/Mini	326
FuboFix	326
FloorFix	326 - 327
Justitec	327
Paneltwistec 1000	328 - 329
Panhead TX	329 - 330
Assembly screw	330
Universal wood construction screw (HBS)	331
Drywall screws	332
Cavity dowel	333
Assembly pliers	333
Eurotec retail shelving unit	334 - 335
Maxi pack	335

# ProPack

Corrugated cardboard, double wall

**NEW**  
to our product range

## Product properties

The Eurotec ProPack offers selected sizes of Paneltwistec in a great value package. It is particularly environmentally friendly and also makes transport of our wood screws easier thanks to its practical handle.

## Advantages

- New, high-quality design
- Practical handle
- Better handling of the screw packaging
- Environmentally friendly package printing
- More cost-effective and environmentally friendly thanks to larger packing unit





# Paneltwistec AG

## Paneltwistec AG

Countersunk-head, blue galvanised



### Advantages

- Faster and simpler screwing-in
- Reduced splitting effect
- National and international approvals
- Contains no chromium(VI) oxide
- No knocking of the screws when screwing in with a TX drive

Art. no.	Dimensions [mm]	Drive	PU
945436	3,5 x 30	TX15 ●	1000
945838	3,5 x 35	TX15 ●	1000
945437	3,5 x 40	TX15 ●	1000
945490	3,5 x 50	TX15 ●	500
945491	4,0 x 30	TX20 ●	1000
945836	4,0 x 35	TX20 ●	1000
945492	4,0 x 40	TX20 ●	1000
945493	4,0 x 45	TX20 ●	500
945494	4,0 x 50	TX20 ●	500
945495	4,0 x 60	TX20 ●	200
945496	4,0 x 70	TX20 ●	200
945497	4,0 x 80	TX20 ●	200
945498	4,5 x 40	TX25 ●	500
945588	4,5 x 45	TX25 ●	500
945499	4,5 x 50	TX25 ●	500
945567	4,5 x 60	TX25 ●	200
945568	4,5 x 70	TX25 ●	200
945569	4,5 x 80	TX25 ●	200
945574	5,0 x 40	TX25 ●	200
945837	5,0 x 45	TX25 ●	200
945575	5,0 x 50	TX25 ●	200
945576	5,0 x 60	TX25 ●	200
945577	5,0 x 70	TX25 ●	200
945578	5,0 x 80	TX25 ●	200
945579	5,0 x 90	TX25 ●	200
945580	5,0 x 100	TX25 ●	200
945581	5,0 x 120	TX25 ●	200
945583	6,0 x 60	TX30 ●	200
945584	6,0 x 70	TX30 ●	200
945632	6,0 x 80	TX30 ●	200
945633	6,0 x 90	TX30 ●	100
945634	6,0 x 100	TX30 ●	100
945635	6,0 x 110	TX30 ●	100
945636	6,0 x 120	TX30 ●	100
945637	6,0 x 130	TX30 ●	100
945638	6,0 x 140	TX30 ●	100
945639	6,0 x 150	TX30 ●	100
945640	6,0 x 160	TX30 ●	100
945641	6,0 x 180	TX30 ●	100
945642	6,0 x 200	TX30 ●	100
945643	6,0 x 220	TX30 ●	100
945644	6,0 x 240	TX30 ●	100
945645	6,0 x 260	TX30 ●	100
945646	6,0 x 280	TX30 ●	100
945647	6,0 x 300	TX30 ●	100



## Paneltwistec AG

Countersunk-head, blue galvanised



### Advantages

- Faster and simpler screwing-in
- Reduced splitting effect
- National and international approvals
- Contains no chromium(VI) oxide
- No knocking of the screws when screwing in with a TX drive



Art. no.	Dimensions [mm]	Drive	PU
944715	8,0 x 80	TX40 ●	50
944716	8,0 x 100	TX40 ●	50
944717	8,0 x 120	TX40 ●	50
944718	8,0 x 140	TX40 ●	50
944719	8,0 x 160	TX40 ●	50
944720	8,0 x 180	TX40 ●	50
944721	8,0 x 200	TX40 ●	50
944722	8,0 x 220	TX40 ●	50
944723	8,0 x 240	TX40 ●	50
944724	8,0 x 260	TX40 ●	50
944725	8,0 x 280	TX40 ●	50
944726	8,0 x 300	TX40 ●	50
944727	8,0 x 320	TX40 ●	50
944728	8,0 x 340	TX40 ●	50
944729	8,0 x 360	TX40 ●	50
944730	8,0 x 380	TX40 ●	50
944731	8,0 x 400	TX40 ●	50
944732	8,0 x 420	TX40 ●	25
944733	8,0 x 440	TX40 ●	25
944734	8,0 x 460	TX40 ●	25
944735	8,0 x 480	TX40 ●	25
944736	8,0 x 500	TX40 ●	25
944737	8,0 x 550	TX40 ●	25
944739	8,0 x 600	TX40 ●	25
945687	10 x 100	TX50 ●	50
945688	10 x 120	TX50 ●	50
945689	10 x 140	TX50 ●	50
945690	10 x 160	TX50 ●	50
945691	10 x 180	TX50 ●	50
945692	10 x 200	TX50 ●	50
945693	10 x 220	TX50 ●	50
945694	10 x 240	TX50 ●	50
945695	10 x 260	TX50 ●	50
945696	10 x 280	TX50 ●	50
945697	10 x 300	TX50 ●	50
945698	10 x 320	TX50 ●	50
945699	10 x 340	TX50 ●	50
945703	10 x 360	TX50 ●	50
945709	10 x 380	TX50 ●	50
945711	10 x 400	TX50 ●	50

Art. no.	Dimensions [mm]	Drive	PU
<b>ProPack</b>			
PRO945632	6,0 x 80	TX30 ●	500
PRO945634	6,0 x 100	TX30 ●	400
PRO945636	6,0 x 120	TX30 ●	400
PRO945638	6,0 x 140	TX30 ●	400
PRO945640	6,0 x 160	TX30 ●	300
PRO945641	6,0 x 180	TX30 ●	300
PRO944716	8,0 x 100	TX40 ●	400
PRO944717	8,0 x 120	TX40 ●	400
PRO944718	8,0 x 140	TX40 ●	300
PRO944719	8,0 x 160	TX40 ●	300
PRO944720	8,0 x 180	TX40 ●	300
PRO944721	8,0 x 200	TX40 ●	150
PRO944722	8,0 x 220	TX40 ●	150
PRO944723	8,0 x 240	TX40 ●	150
PRO944724	8,0 x 260	TX40 ●	150
PRO944725	8,0 x 280	TX40 ●	150
PRO944726	8,0 x 300	TX40 ●	150



Available in ProPack



# Technical information

## Paneltwistec AG, countersunk-head, blue galvanised



Dimensions				Extraction resistance	Head pull-through resistance	Wood / wood shearing				Steel / wood shearing			
					$F_{ax,90,Rk}$	$F_{ax,head,Rk}$	$F_{l\alpha,Rk}$	$F_{l\alpha,Rk}$	$F_{l\alpha,Rk}$	$F_{l\alpha,Rk}$	$t$	$F_{l\alpha,Rk}$	$F_{l\alpha,Rk}$
					[kN]	[kN]	[kN]	[kN]	[kN]	[kN]	[kN]	[kN]	[kN]
$d1 \times L$ [mm]	$dk$ [mm]	$AD$ [mm]	$ET$ [mm]				$\alpha=0^\circ$	$\alpha=90^\circ$	$\alpha_{AD}=0^\circ$	$\alpha_{AD}=90^\circ$		$\alpha=0^\circ$	$\alpha=90^\circ$
3,5 x 30	7,0	12	18	0,84	0,59			0,62			1	0,86	
3,5 x 35	7,0	14	21	0,98	0,59			0,67			1	0,92	
3,5 x 40	7,0	16	24	1,12	0,59			0,70			1	0,95	
3,5 x 45	7,0	18	27	1,26	0,59			0,74			1	0,99	
3,5 x 50	7,0	20	30	1,40	0,59			0,78			1	1,02	
4,0 x 30	8,0	12	18	0,93	0,77			0,71			2	0,91	
4,0 x 35	8,0	14	21	1,08	0,77			0,80			2	1,07	
4,0 x 40	8,0	16	24	1,24	0,77			0,84			2	1,15	
4,0 x 45	8,0	18	27	1,39	0,77			0,88			2	1,19	
4,0 x 50	8,0	20	30	1,55	0,77			0,92			2	1,23	
4,0 x 60	8,0	24	36	1,86	0,77			1,01			2	1,31	
4,0 x 70	8,0	28	42	2,17	0,77			1,03			2	1,38	
4,0 x 80	8,0	32	48	2,48	0,77			1,03			2	1,46	
4,5 x 40	9,0	16	24	1,35	0,97			1,00			2	1,34	
4,5 x 45	9,0	18	27	1,52	0,97			1,03			2	1,40	
4,5 x 50	9,0	20	30	1,69	0,97			1,08			2	1,44	
4,5 x 60	9,0	24	36	2,03	0,97			1,17			2	1,53	
4,5 x 70	9,0	28	42	2,36	0,97			1,26			2	1,61	
4,5 x 80	9,0	32	48	2,70	0,97			1,26			2	1,70	
5,0 x 40	10,0	16	24	1,45	1,20			1,11			2	1,44	
5,0 x 45	10,0	18	27	1,63	1,20			1,20			2	1,62	
5,0 x 50	10,0	20	30	1,82	1,20			1,24			2	1,67	
5,0 x 60	10,0	24	36	2,18	1,20			1,34			2	1,76	
5,0 x 70	10,0	28	42	2,54	1,20			1,44			2	1,85	
5,0 x 80	10,0	32	48	2,90	1,20			1,52			2	1,94	
5,0 x 90	10,0	36	54	3,27	1,20			1,52			2	2,03	
5,0 x 100	10,0	40	60	3,63	1,20			1,52			2	2,12	
5,0 x 120	10,0	50	70	4,24	1,20			1,52			2	2,27	

Calculation according to ETA-11/0024. Wood density  $\rho_k = 350 \text{ kg/m}^3$ . All mechanical values provided should be viewed as subject to the assumptions that have been made and represent example calculations.

All values are calculated minimum values and are subject to typographical and printing errors.

a) The characteristic values of the load-bearing capacity  $R_k$  cannot be treated as equivalent to the max. possible load (the max. force). Characteristic values of the load-bearing capacity  $R_k$  should be reduced to dimensioning values  $R_d$  with regard to the usage class and class of the load duration:  $R_d = R_k \cdot k_{mod} / \gamma_M$ . The dimensioning values of the load-bearing capacity  $R_d$  should be contrasted with the dimensioning values of the loads ( $R_d \geq E_d$ ).

### Example:

Characteristic value for constant load (dead weight)  $G_k = 2,00 \text{ kN}$  and variable load (e. g. snow load)  $Q_k = 3,00 \text{ kN}$ .  $k_{mod} = 0,9$ .  $\gamma_M = 1,3$ .

→ Dimensioning value of the load  $E_d = 2,00 \cdot 1,35 + 3,00 \cdot 1,5 = 7,20 \text{ kN}$ .

The load-bearing capacity of the joint is therefore considered to have been demonstrated if  $R_d \geq E_d$  →  $\min R_k = R_d \cdot \gamma_M / k_{mod}$

i.e. the characteristic minimum value is calculated based on:  $\min R_k = R_d \cdot \gamma_M / k_{mod} \rightarrow R_k = 7,20 \text{ kN} \cdot 1,3 / 0,9 = 10,40 \text{ kN}$  → comparison with table values.

Please note: These are planning aids. Projects must only be calculated by authorised persons.

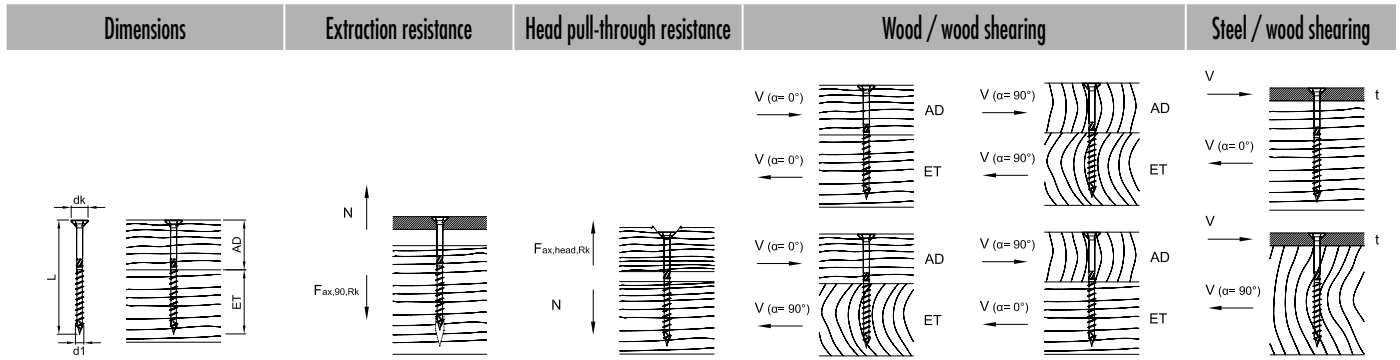

d1 x L [mm]	dk [mm]	AD [mm]	ET [mm]	Fax,90,Rk [kN]	Fax,head,Rk [kN]	Wood / wood shearing				t [mm]	Steel / wood shearing	
						F <sub>l<sub>0</sub>,Rk</sub> [kN]	F <sub>l<sub>90</sub>,Rk</sub> [kN]	F <sub>l<sub>0</sub>,Rk</sub> [kN]	F <sub>l<sub>90</sub>,Rk</sub> [kN]		F <sub>l<sub>0</sub>,Rk</sub> [kN]	F <sub>l<sub>90</sub>,Rk</sub> [kN]
						α=0°	α=90°	α <sub>AD</sub> =0° α <sub>ET</sub> =90°	α <sub>AD</sub> =90° α <sub>ET</sub> =0°		α=0°	α=90°
6,0 x 60	12,0	24	36	2,46	1,73			1,71		2	2,26	
6,0 x 70	12,0	28	42	2,87	1,73			1,82		2	2,36	
6,0 x 80	12,0	32	48	3,28	1,73			1,93		2	2,46	
6,0 x 90	12,0	36	54	3,69	1,73			2,05		2	2,57	
6,0 x 100	12,0	40	60	4,10	1,73			2,07		2	2,67	
6,0 x 110	12,0	40	70	4,79	1,73			2,07		2	2,84	
6,0 x 120	12,0	50	70	4,79	1,73			2,07		2	2,84	
6,0 x 130	12,0	60	70	4,79	1,73			2,07		2	2,84	
6,0 x 140	12,0	70	70	4,79	1,73			2,07		2	2,84	
6,0 x 150	12,0	80	70	4,79	1,73			2,07		2	2,84	
6,0 x 160	12,0	90	70	4,79	1,73			2,07		2	2,84	
6,0 x 180	12,0	110	70	4,79	1,73			2,07		2	2,84	
6,0 x 200	12,0	130	70	4,79	1,73			2,07		2	2,84	
6,0 x 220	12,0	150	70	4,79	1,73			2,07		2	2,84	
6,0 x 240	12,0	170	70	4,79	1,73			2,07		2	2,84	
6,0 x 260	12,0	190	70	4,79	1,73			2,07		2	2,84	
6,0 x 280	12,0	210	70	4,79	1,73			2,07		2	2,84	
6,0 x 300	12,0	230	70	4,79	1,73			2,07		2	2,84	
8,0 x 80	14,5	30	50	4,26	2,52	3,71	2,90	3,71	2,90	3	4,56	3,94
8,0 x 100	14,5	40	60	5,33	2,52	4,13	3,30	4,13	3,30	3	4,83	4,20
8,0 x 120	14,5	50	70	5,86	2,52	4,13	3,50	4,13	3,50	3	4,96	4,34
8,0 x 140	14,5	60	100	8,44	2,52	4,13	3,30	4,13	3,30	3	5,60	4,98
8,0 x 160	14,5	60	100	8,44	2,52	4,13	3,50	4,13	3,50	3	5,60	4,98
8,0 x 180	14,5	80	100	8,44	2,52	4,13	3,50	4,13	3,50	3	5,60	4,98
8,0 x 200	14,5	100	100	8,44	2,52	4,13	3,50	3,50	4,13	3	5,60	4,98
8,0 x 220	14,5	120	100	8,44	2,52	4,13	3,50	3,50	4,13	3	5,60	4,98
8,0 x 240	14,5	140	100	8,44	2,52	4,13	3,50	3,50	4,13	3	5,60	4,98
8,0 x 260	14,5	160	100	8,44	2,52	4,13	3,50	3,50	4,13	3	5,60	4,98
8,0 x 280	14,5	180	100	8,44	2,52	4,13	3,50	3,50	4,13	3	5,60	4,98
8,0 x 300	14,5	200	100	8,44	2,52	4,13	3,50	3,50	4,13	3	5,60	4,98
8,0 x 320	14,5	220	100	8,44	2,52	4,13	3,50	3,50	4,13	3	5,60	4,98
8,0 x 340	14,5	240	100	8,44	2,52	4,13	3,50	3,50	4,13	3	5,60	4,98
8,0 x 360	14,5	260	100	8,44	2,52	4,13	3,50	3,50	4,13	3	5,60	4,98
8,0 x 380	14,5	280	100	8,44	2,52	4,13	3,50	3,50	4,13	3	5,60	4,98
8,0 x 400	14,5	300	100	8,44	2,52	4,13	3,50	3,50	4,13	3	5,60	4,98

Calculation according to ETA-11/0024. Wood density ρ<sub>1</sub> = 350 kg/m<sup>3</sup>. All mechanical values provided should be viewed as subject to the assumptions that have been made and represent example calculations.

All values are calculated minimum values and are subject to typographical and printing errors.

a) The characteristic values of the load-bearing capacity R<sub>k</sub> cannot be treated as equivalent to the max. possible load (the max. force). Characteristic values of the load-bearing capacity R<sub>k</sub> should be reduced to dimensioning values R<sub>d</sub> with regard to the usage class and class of the load duration: R<sub>d</sub> = R<sub>k</sub> · k<sub>mod</sub> / γ<sub>M</sub>. The dimensioning values of the load-bearing capacity R<sub>d</sub> should be contrasted with the dimensioning values of the loads (R<sub>d</sub> ≥ E<sub>d</sub>).

**Example:**

Characteristic value for constant load (dead weight) G<sub>k</sub> = 2,00 kN and variable load (e. g. snow load) Q<sub>k</sub> = 3,00 kN. k<sub>mod</sub> = 0,9. γ<sub>M</sub> = 1,3.

→ Dimensioning value of the load E<sub>d</sub> = 2,00 · 1,35 + 3,00 · 1,5 = 7,20 kN.

The load-bearing capacity of the joint is therefore considered to have been demonstrated if R<sub>d</sub> ≥ E<sub>d</sub>. → min R<sub>k</sub> = R<sub>d</sub> · γ<sub>M</sub> / k<sub>mod</sub>

i.e. the characteristic minimum value is calculated based on: min R<sub>k</sub> = R<sub>d</sub> · γ<sub>M</sub> / k<sub>mod</sub> → R<sub>k</sub> = 7,20 kN · 1,3 / 0,9 = 10,40 kN → comparison with table values.

Please note: These are planning aids. Projects must only be calculated by authorised persons.

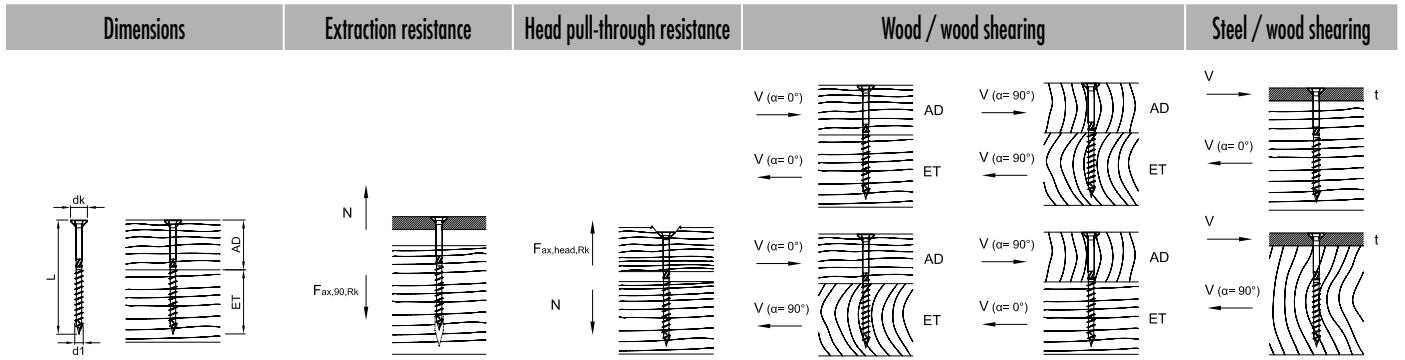

d1 x L [mm]	dk [mm]	AD [mm]	ET [mm]	Fax,90,Rk [kN]	Fax,head,Rk [kN]	F <sub>la,Rk</sub>	F <sub>la,Rk</sub>	F <sub>la,Rk</sub>	F <sub>la,Rk</sub>	t [mm]	F <sub>la,Rk</sub>	F <sub>la,Rk</sub>
						[kN]	[kN]	[kN]	[kN]		[kN]	[kN]
						α=0°	α=90°	α <sub>AD</sub> =0° α <sub>ET</sub> =90°	α <sub>AD</sub> =90° α <sub>ET</sub> =0°		α=0°	α=90°
8,0 x 420	14,5	300	100	8,44	2,52	4,13	3,50	3,50	4,13	3	5,60	4,98
8,0 x 440	14,5	300	100	8,44	2,52	4,13	3,50	3,50	4,13	3	5,60	4,98
8,0 x 460	14,5	300	100	8,44	2,52	4,13	3,50	3,50	4,13	3	5,60	4,98
8,0 x 480	14,5	300	100	8,44	2,52	4,13	3,50	3,50	4,13	3	5,60	4,98
8,0 x 500	14,5	300	100	8,44	2,52	4,13	3,50	3,50	4,13	3	5,60	4,98
8,0 x 550	14,5	300	100	8,44	2,52	4,13	3,50	3,50	4,13	3	5,60	4,98
8,0 x 600	14,5	300	100	8,44	2,52	4,13	3,50	3,50	4,13	3	5,60	4,98
10,0 x 100	17,8	40	60	6,48	3,63	5,73	4,37	5,73	4,37	3	6,78	5,81
10,0 x 120	17,8	50	70	7,13	3,63	6,07	4,87	6,07	4,87	3	6,94	5,97
10,0 x 140	17,8	40	100	10,26	3,63	5,73	4,37	5,73	4,37	3	7,72	6,76
10,0 x 160	17,8	60	100	10,26	3,63	6,07	5,10	6,07	5,10	3	7,72	6,76
10,0 x 180	17,8	80	100	10,26	3,63	6,07	5,10	6,07	5,10	3	7,72	6,76
10,0 x 200	17,8	100	100	10,26	3,63	6,07	5,10	5,10	6,07	3	7,72	6,76
10,0 x 220	17,8	120	100	10,26	3,63	6,07	5,10	5,10	6,07	3	7,72	6,76
10,0 x 240	17,8	140	100	10,26	3,63	6,07	5,10	5,10	6,07	3	7,72	6,76
10,0 x 260	17,8	160	100	10,26	3,63	6,07	5,10	5,10	6,07	3	7,72	6,76
10,0 x 280	17,8	180	100	10,26	3,63	6,07	5,10	5,10	6,07	3	7,72	6,76
10,0 x 300	17,8	200	100	10,26	3,63	6,07	5,10	5,10	6,07	3	7,72	6,76
10,0 x 320	17,8	220	100	10,26	3,63	6,07	5,10	5,10	6,07	3	7,72	6,76
10,0 x 340	17,8	240	100	10,26	3,63	6,07	5,10	5,10	6,07	3	7,72	6,76
10,0 x 360	17,8	260	100	10,26	3,63	6,07	5,10	5,10	6,07	3	7,72	6,76
10,0 x 380	17,8	280	100	10,26	3,63	6,07	5,10	5,10	6,07	3	7,72	6,76
10,0 x 400	17,8	300	100	10,26	3,63	6,07	5,10	5,10	6,07	3	7,72	6,76

Calculation according to ETA-11/0024. Wood density ρ<sub>k</sub>= 350 kg/m<sup>3</sup>. All mechanical values provided should be viewed as subject to the assumptions that have been made and represent example calculations.

All values are calculated minimum values and are subject to typographical and printing errors.

a) The characteristic values of the load-bearing capacity R<sub>k</sub> cannot be treated as equivalent to the max. possible load (the max. force). Characteristic values of the load-bearing capacity R<sub>k</sub> should be reduced to dimensioning values R<sub>d</sub> with regard to the usage class and class of the load duration: R<sub>d</sub>= R<sub>k</sub> · k<sub>mod</sub> / γ<sub>M</sub>. The dimensioning values of the load-bearing capacity R<sub>d</sub> should be contrasted with the dimensioning values of the loads (R<sub>d</sub> ≥ E<sub>d</sub>).

**Example:**

Characteristic value for constant load (dead weight) G<sub>k</sub>= 2,00 kN and variable load (e. g. snow load) Q<sub>k</sub>= 3,00 kN. k<sub>mod</sub>= 0,9. γ<sub>M</sub>= 1,3.

→ Dimensioning value of the load E<sub>d</sub>= 2,00 · 1,35 + 3,00 · 1,5= 7,20 kN.

The load-bearing capacity of the joint is therefore considered to have been demonstrated if R<sub>d</sub> ≥ E<sub>d</sub> → min R<sub>d</sub>= R<sub>k</sub> · γ<sub>M</sub> / k<sub>mod</sub>

i.e. the characteristic minimum value is calculated based on: min R<sub>k</sub>= R<sub>d</sub> · γ<sub>M</sub> / k<sub>mod</sub> → R<sub>k</sub>= 7,20 kN · 1,3/0,9= 10,40 kN → comparison with table values.

Please note: These are planning aids. Projects must only be calculated by authorised persons.

## Paneltwistec AG

Flanged button-head screw, blue galvanised



- The larger head diameter allows for considerably higher torque and head pull-through capacity
- This makes for better use of the screw's tensile load-bearing strength



**Available in ProPack**

Art. no.	Dimensions [mm]	Drive	PU
946158	4,0 x 40	TX20 ●	500
946159	4,0 x 50	TX20 ●	500
946160	4,0 x 60	TX20 ●	500
946161	4,5 x 50	TX20 ●	200
946162	4,5 x 60	TX20 ●	200
946163	4,5 x 70	TX20 ●	200
946037	5,0 x 50	TX25 ●	200
946038	5,0 x 60	TX25 ●	200
946039	5,0 x 70	TX25 ●	200
946040	5,0 x 80	TX25 ●	200
946042	5,0 x 100	TX25 ●	200
945947	6,0 x 30	TX30 ●	100
945948	6,0 x 40	TX30 ●	100
945712	6,0 x 50	TX30 ●	100
945713	6,0 x 60	TX30 ●	100
945716	6,0 x 70	TX30 ●	100
945717	6,0 x 80	TX30 ●	100
945718	6,0 x 90	TX30 ●	100
945719	6,0 x 100	TX30 ●	100
945720	6,0 x 110	TX30 ●	100
945721	6,0 x 120	TX30 ●	100
945722	6,0 x 130	TX30 ●	100
945723	6,0 x 140	TX30 ●	100
945724	6,0 x 150	TX30 ●	100
945725	6,0 x 160	TX30 ●	100
945726	6,0 x 180	TX30 ●	100
945727	6,0 x 200	TX30 ●	100
945728	6,0 x 220	TX30 ●	100
945729	6,0 x 240	TX30 ●	100
945730	6,0 x 260	TX30 ●	100
945731	6,0 x 280	TX30 ●	100
945732	6,0 x 300	TX30 ●	100

Art. no.	Dimensions [mm]	Drive	PU
<b>ProPack</b>			
PRO945719	6,0 x 100	TX30 ●	400
PRO945721	6,0 x 120	TX30 ●	400
PRO945723	6,0 x 140	TX30 ●	400
PRO945725	6,0 x 160	TX30 ●	300
PRO945726	6,0 x 180	TX30 ●	300

## Paneltwistec AG

Flanged button-head screw, blue galvanised



- The larger head diameter allows for considerably higher torque and head pull-through capacity
- This makes for better use of the screw's tensile load-bearing strength



Art. no.	Dimensions [mm]	Drive	PU
945806	8,0 x 60	TX40 ●	50
944588	8,0 x 80	TX40 ●	50
944589	8,0 x 100	TX40 ●	50
944590	8,0 x 120	TX40 ●	50
944591	8,0 x 140	TX40 ●	50
944592	8,0 x 160	TX40 ●	50
944593	8,0 x 180	TX40 ●	50
944594	8,0 x 200	TX40 ●	50
944595	8,0 x 220	TX40 ●	50
944596	8,0 x 240	TX40 ●	50
944597	8,0 x 260	TX40 ●	50
944598	8,0 x 280	TX40 ●	50
944599	8,0 x 300	TX40 ●	50
944600	8,0 x 320	TX40 ●	50
944601	8,0 x 340	TX40 ●	50
944602	8,0 x 360	TX40 ●	50
944603	8,0 x 380	TX40 ●	50
944604	8,0 x 400	TX40 ●	50
944605	8,0 x 420	TX40 ●	25

More sizes on the next page





Available in ProPack

Art. no.	Dimensions [mm]	Drive	PU
944606	8,0 x 440	TX40 ●	25
944607	8,0 x 460	TX40 ●	25
944608	8,0 x 480	TX40 ●	25
944609	8,0 x 500	TX40 ●	25
944610	8,0 x 550	TX40 ●	25
944611	8,0 x 600	TX40 ●	25

Art. no.	Dimensions [mm]	Drive	PU
<b>ProPack</b>			
PRO944588	8,0 x 80	TX40 ●	250
PRO944589	8,0 x 100	TX40 ●	250
PRO944590	8,0 x 120	TX40 ●	250
PRO944591	8,0 x 140	TX40 ●	200
PRO944592	8,0 x 160	TX40 ●	200
PRO944593	8,0 x 180	TX40 ●	200
PRO944594	8,0 x 200	TX40 ●	100
PRO944595	8,0 x 220	TX40 ●	100
PRO944596	8,0 x 240	TX40 ●	100
PRO944597	8,0 x 260	TX40 ●	100
PRO944598	8,0 x 280	TX40 ●	100
PRO944599	8,0 x 300	TX40 ●	100
PRO944600	8,0 x 320	TX40 ●	100

## Paneltwistec AG

Flanged button-head screw, blue galvanised



- The larger head diameter allows for considerably higher torque and head pull-through capacity
- This makes for better use of the screw's tensile load-bearing strength



Art. no.	Dimensions [mm]	Drive	PU
945750	10 x 80	TX50 ●	50
945751	10 x 100	TX50 ●	50
945752	10 x 120	TX50 ●	50
945753	10 x 140	TX50 ●	50
945754	10 x 160	TX50 ●	50
945755	10 x 180	TX50 ●	50
945756	10 x 200	TX50 ●	50
945757	10 x 220	TX50 ●	50
945758	10 x 240	TX50 ●	50
945759	10 x 260	TX50 ●	50
945760	10 x 280	TX50 ●	50
945761	10 x 300	TX50 ●	50
945762	10 x 320	TX50 ●	50
945763	10 x 340	TX50 ●	50
945764	10 x 360	TX50 ●	50
945765	10 x 380	TX50 ●	50
945766	10 x 400	TX50 ●	50



Only suitable for insulating materials  $\geq 50$  kPa (pressure-resistant)

# Technical information

## Paneltwistec AG, countersunk-head, blue galvanised

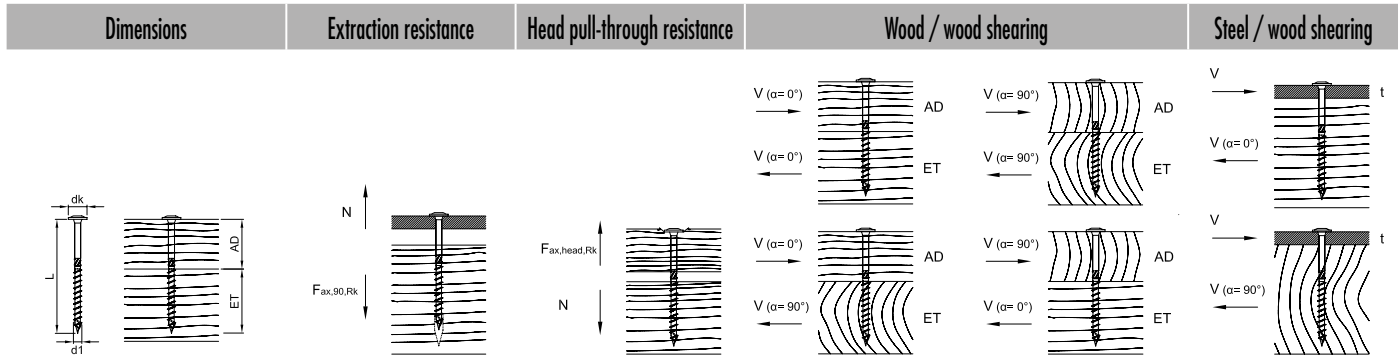

d1 x L [mm]	dk [mm]	AD [mm]	ET [mm]	Fax,90,Rk [kN]	Fax,head,Rk [kN]	F <sub>l0,Rk</sub> [kN]		F <sub>l0,Rk</sub> [kN]		t [mm]	F <sub>l0,Rk</sub> [kN]	
						α=0°	α=90°	α <sub>ET</sub> =90°	α <sub>AD</sub> =0°		α=0°	α=90°
4,0 x 40	10,0	16	24	1,24	1,20		0,95			2	1,15	
4,0 x 50	10,0	20	30	1,55	1,20		1,03			2	1,23	
4,0 x 60	10,0	24	36	1,86	1,20		1,12			2	1,31	
4,5 x 50	11,0	20	30	1,69	1,45		1,20			2	1,44	
4,5 x 60	11,0	24	36	2,03	1,45		1,29			2	1,53	
4,5 x 70	11,0	28	42	2,36	1,45		1,38			2	1,61	
5,0 x 50	12,0	20	30	1,82	1,73		1,37			2	1,67	
5,0 x 60	12,0	24	36	2,18	1,73		1,47			2	1,76	
5,0 x 70	12,0	28	42	2,54	1,73		1,57			2	1,85	
5,0 x 80	12,0	32	48	2,90	1,73		1,65			2	1,94	
5,0 x 100	12,0	40	60	3,63	1,73		1,65			2	2,12	
6,0 x 30	14,0	6	24	1,64	2,35		0,65			2	1,20	
6,0 x 40	14,0	16	24	1,64	2,35		1,33			2	1,63	
6,0 x 50	14,0	20	30	2,05	2,35		1,66			2	2,06	
6,0 x 60	14,0	24	36	2,46	2,35		1,87			2	2,26	
6,0 x 70	14,0	28	42	2,87	2,35		1,97			2	2,36	
6,0 x 80	14,0	32	48	3,28	2,35		2,09			2	2,46	
6,0 x 90	14,0	36	54	3,69	2,35		2,21			2	2,57	
6,0 x 100	14,0	40	60	4,10	2,35		2,23			2	2,67	
6,0 x 110	14,0	44	66	4,79	2,35		2,23			2	2,77	
6,0 x 120	14,0	50	70	4,79	2,35		2,23			2	2,84	
6,0 x 130	14,0	60	70	4,79	2,35		2,23			2	2,84	
6,0 x 140	14,0	70	70	4,79	2,35		2,23			2	2,84	
6,0 x 150	14,0	80	70	4,79	2,35		2,23			2	2,84	
6,0 x 160	14,0	90	70	4,79	2,35		2,23			2	2,84	
6,0 x 180	14,0	110	70	4,79	2,35		2,23			2	2,84	
6,0 x 200	14,0	130	70	4,79	2,35		2,23			2	2,84	
6,0 x 220	14,0	150	70	4,79	2,35		2,23			2	2,84	
6,0 x 240	14,0	170	70	4,79	2,35		2,23			2	2,84	
6,0 x 260	14,0	190	70	4,79	2,35		2,23			2	2,84	
6,0 x 280	14,0	210	70	4,79	2,35		2,23			2	2,84	
6,0 x 300	14,0	230	70	4,79	2,35		2,23			2	2,84	

Calculation according to ETA-11/0024. Wood density ρ<sub>k</sub>= 350 kg/m<sup>3</sup>. All mechanical values provided should be viewed as subject to the assumptions that have been made and represent example calculations.

All values are calculated minimum values and are subject to typographical and printing errors.

a) The characteristic values of the load-bearing capacity R<sub>k</sub> cannot be treated as equivalent to the max. possible load (the max. force). Characteristic values of the load-bearing capacity R<sub>k</sub> should be reduced to dimensioning values R<sub>d</sub> with regard to the usage class and class of the load duration: R<sub>d</sub>= R<sub>k</sub> · k<sub>mod</sub> / γ<sub>M</sub>. The dimensioning values of the load-bearing capacity R<sub>d</sub> should be contrasted with the dimensioning values of the loads (R<sub>d</sub> ≥ E<sub>d</sub>).

### Example:

Characteristic value for constant load (dead weight) G<sub>k</sub>= 2,00 kN and variable load (e. g. snow load) Q<sub>k</sub>= 3,00 kN. k<sub>mod</sub>= 0,9. γ<sub>M</sub>= 1,3.

→ Dimensioning value of the load E<sub>d</sub>= 2,00 · 1,35 + 3,00 · 1,5= 7,20 kN.

The load-bearing capacity of the joint is therefore considered to have been demonstrated if R<sub>d</sub> ≥ E<sub>d</sub>. → min R<sub>d</sub>= R<sub>k</sub> · γ<sub>M</sub> / k<sub>mod</sub>

i.e. the characteristic minimum value is calculated based on: min R<sub>k</sub>= R<sub>d</sub> · γ<sub>M</sub> / k<sub>mod</sub> → R<sub>k</sub>= 7,20 kN · 1,3/0,9= 10,40 kN → comparison with table values.

Please note: These are planning aids. Projects must only be calculated by authorised persons.

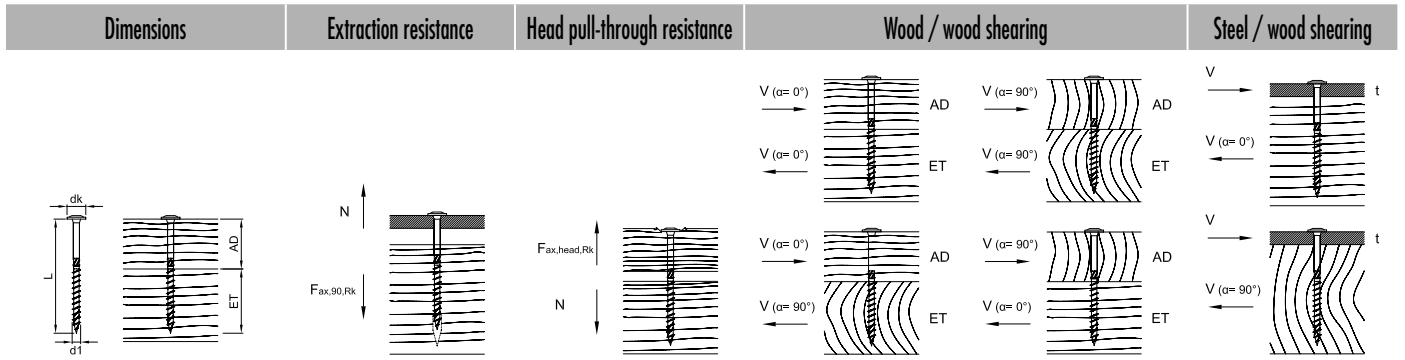

d1 x L [mm]	dk [mm]	AD [mm]	ET [mm]	Fax,90,Rk [kN]	Fax,head,Rk [kN]	Wood / wood shearing				Steel / wood shearing		
						F <sub>l0,Rk</sub> [kN]	F <sub>l0,Rk</sub> [kN]	F <sub>l0,Rk</sub> [kN]	F <sub>l0,Rk</sub> [kN]	t [mm]	F <sub>l0,Rk</sub> [kN]	F <sub>l0,Rk</sub> [kN]
						α=0°		α=90°				
								α <sub>AD</sub> =0°	α <sub>AD</sub> =90°			
								α <sub>ET</sub> =90°	α <sub>ET</sub> =0°	α=0°	α=90°	
8,0 x 80	22,0	30	50	4,26	5,81	4,14	3,34	4,14	3,34	3	4,56	3,94
8,0 x 100	22,0	40	60	5,33	5,81	4,83	4,01	4,83	4,01	3	4,83	4,20
8,0 x 120	22,0	50	70	5,86	5,81	4,95	4,32	4,95	4,32	3	4,96	4,34
8,0 x 140	22,0	40	100	8,44	5,81	4,95	4,13	4,95	4,13	3	5,60	4,98
8,0 x 160	22,0	60	100	8,44	5,81	4,95	4,32	4,95	4,32	3	5,60	4,98
8,0 x 180	22,0	80	100	8,44	5,81	4,95	4,32	4,95	4,32	3	5,60	4,98
8,0 x 200	22,0	100	100	8,44	5,81	4,95	4,32	4,32	4,95	3	5,60	4,98
8,0 x 220	22,0	120	100	8,44	5,81	4,95	4,32	4,32	4,95	3	5,60	4,98
8,0 x 240	22,0	140	100	8,44	5,81	4,95	4,32	4,32	4,95	3	5,60	4,98
8,0 x 260	22,0	160	100	8,44	5,81	4,95	4,32	4,32	4,95	3	5,60	4,98
8,0 x 280	22,0	180	100	8,44	5,81	4,95	4,32	4,32	4,95	3	5,60	4,98
8,0 x 300	22,0	200	100	8,44	5,81	4,95	4,32	4,32	4,95	3	5,60	4,98
8,0 x 320	22,0	220	100	8,44	5,81	4,95	4,32	4,32	4,95	3	5,60	4,98
8,0 x 340	22,0	240	100	8,44	5,81	4,95	4,32	4,32	4,95	3	5,60	4,98
8,0 x 360	22,0	260	100	8,44	5,81	4,95	4,32	4,32	4,95	3	5,60	4,98
8,0 x 380	22,0	280	100	8,44	5,81	4,95	4,32	4,32	4,95	3	5,60	4,98
8,0 x 400	22,0	300	100	8,44	5,81	4,95	4,32	4,32	4,95	3	5,60	4,98
8,0 x 420	22,0	300	100	8,44	5,81	4,95	4,32	4,32	4,95	3	5,60	4,98
8,0 x 440	22,0	300	100	8,44	5,81	4,95	4,32	4,32	4,95	3	5,60	4,98
8,0 x 460	22,0	300	100	8,44	5,81	4,95	4,32	4,32	4,95	3	5,60	4,98
8,0 x 480	22,0	300	100	8,44	5,81	4,95	4,32	4,32	4,95	3	5,60	4,98
8,0 x 500	22,0	300	100	8,44	5,81	4,95	4,32	4,32	4,95	3	5,60	4,98
8,0 x 550	22,0	300	100	8,44	5,81	4,95	4,32	4,32	4,95	3	5,60	4,98
8,0 x 600	22,0	300	100	8,44	5,81	4,95	4,32	4,32	4,95	3	5,60	4,98

Calculation according to ETA-11/0024. Wood density ρ<sub>k</sub>= 350 kg/m<sup>3</sup>. All mechanical values provided should be viewed as subject to the assumptions that have been made and represent example calculations.

All values are calculated minimum values and are subject to typographical and printing errors.

a) The characteristic values of the load-bearing capacity R<sub>k</sub> cannot be treated as equivalent to the max. possible load (the max. force). Characteristic values of the load-bearing capacity R<sub>k</sub> should be reduced to dimensioning values R<sub>d</sub> with regard to the usage class and class of the load duration: R<sub>d</sub>= R<sub>k</sub> · k<sub>mod</sub> / γ<sub>M</sub>. The dimensioning values of the load-bearing capacity R<sub>d</sub> should be contrasted with the dimensioning values of the loads (R<sub>d</sub> ≥ E<sub>d</sub>).

**Example:**

Characteristic value for constant load (dead weight) G<sub>k</sub>= 2,00 kN and variable load (e. g. snow load) Q<sub>k</sub>= 3,00 kN. k<sub>mod</sub>= 0,9 · γ<sub>M</sub>= 1,3.

→ Dimensioning value of the load E<sub>d</sub>= 2,00 · 1,35 + 3,00 · 1,5= 7,20 kN.

The load-bearing capacity of the joint is therefore considered to have been demonstrated if R<sub>d</sub> ≥ E<sub>d</sub> → min R<sub>k</sub>= R<sub>d</sub> · γ<sub>M</sub> / k<sub>mod</sub>

i.e. the characteristic minimum value is calculated based on: min R<sub>k</sub>= R<sub>d</sub> · γ<sub>M</sub> / k<sub>mod</sub> → R<sub>k</sub>= 7,20 kN · 1,3/0,9= 10,40 kN → comparison with table values.

Please note: These are planning aids. Projects must only be calculated by authorised persons.

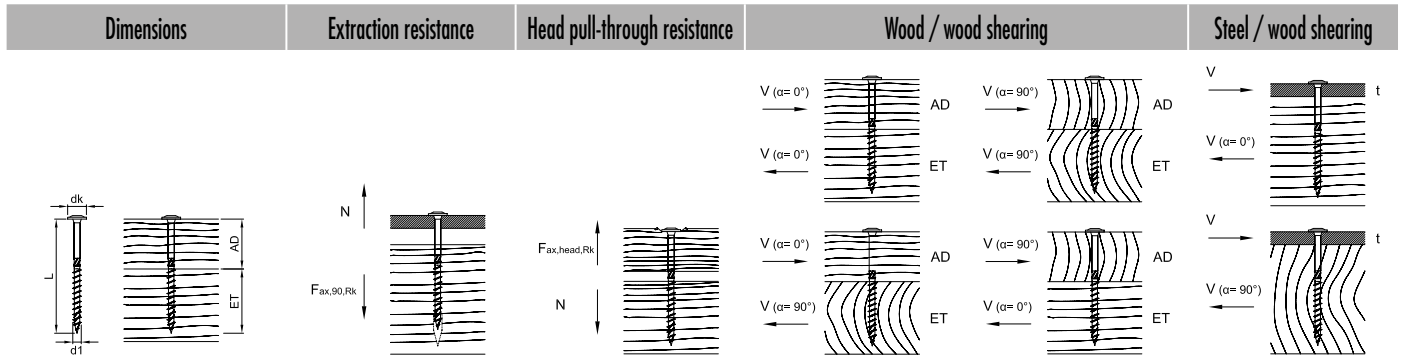

d1 x L [mm]	dk [mm]	AD [mm]	ET [mm]	F <sub>ax,90,Rk</sub> [kN]	F <sub>ax,head,Rk</sub> [kN]	Wood / wood shearing				Steel / wood shearing		
						F <sub>lo,Rk</sub> [kN]	F <sub>lo,Rk</sub> [kN]	F <sub>lo,Rk</sub> [kN]	F <sub>lo,Rk</sub> [kN]	t [mm]	F <sub>lo,Rk</sub> [kN]	F <sub>lo,Rk</sub> [kN]
						α = 0°		α <sub>AD</sub> = 0°				
						α = 90°		α <sub>ET</sub> = 90°		α = 90°		
10,0 x 100	25,0	40	60	6,48	7,50	6,44	5,08	6,44	5,08	3	6,78	5,81
10,0 x 120	25,0	50	70	7,13	7,50	6,94	5,74	6,94	5,74	3	6,94	5,97
10,0 x 140	25,0	40	100	10,26	7,50	6,70	5,34	6,70	5,34	3	7,72	6,76
10,0 x 160	25,0	60	100	10,26	7,50	7,03	6,07	7,03	6,07	3	7,72	6,76
10,0 x 180	25,0	80	100	10,26	7,50	7,03	6,07	7,03	6,07	3	7,72	6,76
10,0 x 200	25,0	100	100	10,26	7,50	7,03	6,07	6,07	7,03	3	7,72	6,76
10,0 x 220	25,0	120	100	10,26	7,50	7,03	6,07	6,07	7,03	3	7,72	6,76
10,0 x 240	25,0	140	100	10,26	7,50	7,03	6,07	6,07	7,03	3	7,72	6,76
10,0 x 260	25,0	160	100	10,26	7,50	7,03	6,07	6,07	7,03	3	7,72	6,76
10,0 x 280	25,0	180	100	10,26	7,50	7,03	6,07	6,07	7,03	3	7,72	6,76
10,0 x 300	25,0	200	100	10,26	7,50	7,03	6,07	6,07	7,03	3	7,72	6,76
10,0 x 320	25,0	220	100	10,26	7,50	7,03	6,07	6,07	7,03	3	7,72	6,76
10,0 x 340	25,0	240	100	10,26	7,50	7,03	6,07	6,07	7,03	3	7,72	6,76
10,0 x 360	25,0	260	100	10,26	7,50	7,03	6,07	6,07	7,03	3	7,72	6,76
10,0 x 380	25,0	280	100	10,26	7,50	7,03	6,07	6,07	7,03	3	7,72	6,76
10,0 x 400	25,0	300	100	10,26	7,50	7,03	6,07	6,07	7,03	3	7,72	6,76

Calculation according to ETA-11/0024. Wood density ρ<sub>k</sub> = 350 kg/m<sup>3</sup>. All mechanical values provided should be viewed as subject to the assumptions that have been made and represent example calculations.

All values are calculated minimum values and are subject to typographical and printing errors.

a) The characteristic values of the load-bearing capacity R<sub>k</sub> cannot be treated as equivalent to the max. possible load (the max. force). Characteristic values of the load-bearing capacity R<sub>k</sub> should be reduced to dimensioning values R<sub>d</sub> with regard to the usage class and class of the load duration: R<sub>d</sub> = R<sub>k</sub> · k<sub>mod</sub> / γ<sub>M</sub>. The dimensioning values of the load-bearing capacity R<sub>d</sub> should be contrasted with the dimensioning values of the loads (R<sub>d</sub> ≥ E<sub>d</sub>).

**Example:**

Characteristic value for constant load (dead weight) G<sub>k</sub> = 2,00 kN and variable load (e. g. snow load) Q<sub>k</sub> = 3,00 kN. k<sub>mod</sub> = 0,9. γ<sub>M</sub> = 1,3.

→ Dimensioning value of the load E<sub>d</sub> = 2,00 · 1,35 + 3,00 · 1,5 = 7,20 kN.

The load-bearing capacity of the joint is therefore considered to have been demonstrated if R<sub>d</sub> ≥ E<sub>d</sub>. → min R<sub>k</sub> = R<sub>d</sub> · γ<sub>M</sub> / k<sub>mod</sub>

i.e. the characteristic minimum value is calculated based on: min R<sub>k</sub> = R<sub>d</sub> · γ<sub>M</sub> / k<sub>mod</sub> → R<sub>k</sub> = 7,20 kN · 1,3 / 0,9 = 10,40 kN → comparison with table values.

Please note: These are planning aids. Projects must only be calculated by authorised persons.



# SawTec

Wood construction screw made of hardened carbon steel



## SawTec

**NEW  
dimensions**

Cylinder head, blue galvanised

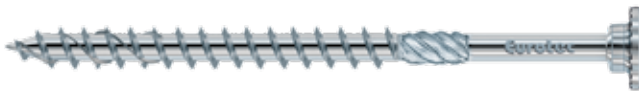

### Description of the wood construction screw for wood/wood and steel joints

- Faster and easier screwing-in due to the DAG tip
- The DAG tip reduces the screw-in torque
- Reduced splitting effect
- Screws do not hit one another when screwed in using the TX drive



### Application information

Can be used in service classes 1 and 2 according to DIN EN 1995 – Eurocode 5



### Advantages of the screw head

- Saw teeth under the head reduce chip placement
- Ideal for fittings
- Careful screwing prevents wearing and splintering of the wood
- Original cylinder and wheel head
- Higher head pull-through values than countersunk head, lower splitting effect than disc head (with inclined screw connection)

### Advantage of the friction part

- Friction creates space for the shank, thereby reducing the screwing-in resistance

### Advantages thread

- The coarse thread is features taper rolled flanks up to the tip
- Enables faster screwing-in

### Advantages DAG screw tip

- The special geometry of the DAG screw tip means that the screw-in torque is reduced and also leads to less of a splitting effect when screwing in



Art. no.	Dimensions [mm]	Drive	PU
954115	5,0 x 40	TX25 ●	200
954117	5,0 x 50	TX25 ●	200
954118	5,0 x 60	TX25 ●	200
954119	5,0 x 70	TX25 ●	200
954120	5,0 x 80	TX25 ●	200
954121	5,0 x 90	TX25 ●	200
954122	5,0 x 100	TX25 ●	200
954124	5,0 x 120	TX25 ●	200
954128	6,0 x 60	TX30 ●	100
954129	6,0 x 70	TX30 ●	100
954130	6,0 x 80	TX30 ●	100
954131	6,0 x 100	TX30 ●	100
954133	6,0 x 120	TX30 ●	100
954135	6,0 x 140	TX30 ●	100
954137	6,0 x 160	TX30 ●	100
954138	6,0 x 180	TX30 ●	100
954145	8,0 x 80	TX40 ●	50
954146	8,0 x 100	TX40 ●	50
954147	8,0 x 120	TX40 ●	50
954148	8,0 x 140	TX40 ●	50
954149	8,0 x 160	TX40 ●	50
954150	8,0 x 180	TX40 ●	50
954151	8,0 x 200	TX40 ●	50
954152	8,0 x 220	TX40 ●	50
954153	8,0 x 240	TX40 ●	50
954154	8,0 x 260	TX40 ●	50
954155	8,0 x 280	TX40 ●	50
954156	8,0 x 300	TX40 ●	50
954157	8,0 x 320	TX40 ●	50
954158	8,0 x 340	TX40 ●	50
954159	8,0 x 360	TX40 ●	50
954160	8,0 x 380	TX40 ●	50
954161	8,0 x 400	TX40 ●	50
954181	8,0 x 420	TX40 ●	50
954182	8,0 x 440	TX40 ●	50
954183	8,0 x 460	TX40 ●	50
954184	8,0 x 480	TX40 ●	50
954185	8,0 x 500	TX40 ●	50
954186	8,0 x 550	TX40 ●	50
954187	8,0 x 600	TX40 ●	50
954162	10,0 x 100	TX50 ●	50
954163	10,0 x 120	TX50 ●	50
954164	10,0 x 140	TX50 ●	50
954165	10,0 x 160	TX50 ●	50
954166	10,0 x 180	TX50 ●	50
954167	10,0 x 200	TX50 ●	50
954168	10,0 x 220	TX50 ●	50
954169	10,0 x 240	TX50 ●	50
954170	10,0 x 260	TX50 ●	50
954171	10,0 x 280	TX50 ●	50
954172	10,0 x 300	TX50 ●	50
954173	10,0 x 320	TX50 ●	50
954174	10,0 x 340	TX50 ●	50
954175	10,0 x 360	TX50 ●	25
954176	10,0 x 380	TX50 ●	25
954177	10,0 x 400	TX50 ●	25



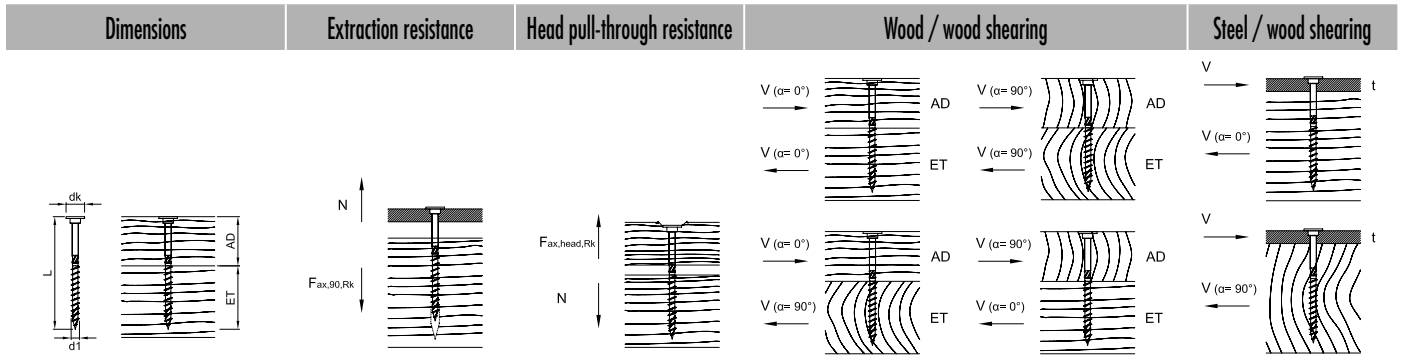

d) x L [mm]	dk [mm]	AD [mm]	ET [mm]	F <sub>ax,90,Rk</sub> [kN]	F <sub>ax,head,Rk</sub> [kN]	Wood / wood shearing				t [mm]	Steel / wood shearing		
						F <sub>lo,Rk</sub> [kN]	F <sub>lo,Rk</sub> [kN]	F <sub>lo,Rk</sub> [kN]	F <sub>lo,Rk</sub> [kN]		F <sub>lo,Rk</sub> [kN]	F <sub>lo,Rk</sub> [kN]	
						α <sub>AD</sub> = 0°		α <sub>AD</sub> = 90°					
						α = 0°		α = 90°		α = 0°		α = 90°	
8,0 x 80	18,0	30	50	4,26	3,24	3,89	3,08	3,89	3,08	3	4,61	3,94	
8,0 x 100	18,0	40	60	5,33	3,24	4,31	3,48	4,31	3,48	3	4,83	4,20	
8,0 x 120	18,0	60	60	5,33	3,24	4,31	3,68	4,31	3,68	3	4,83	4,20	
8,0 x 140	18,0	40	100	8,44	3,24	4,31	3,48	4,31	3,48	3	5,60	4,98	
8,0 x 160	18,0	60	100	8,44	3,24	4,31	3,68	4,31	3,68	3	5,60	4,98	
8,0 x 180	18,0	80	100	8,44	3,24	4,31	3,68	4,31	3,68	3	5,60	4,98	
8,0 x 200	18,0	100	100	8,44	3,24	4,31	3,68	3,68	4,31	3	5,60	4,98	
8,0 x 220	18,0	120	100	8,44	3,24	4,31	3,68	3,68	4,31	3	5,60	4,98	
8,0 x 240	18,0	140	100	8,44	3,24	4,31	3,68	3,68	4,31	3	5,60	4,98	
8,0 x 260	18,0	160	100	8,44	3,24	4,31	3,68	3,68	4,31	3	5,60	4,98	
8,0 x 280	18,0	180	100	8,44	3,24	4,31	3,68	3,68	4,31	3	5,60	4,98	
8,0 x 300	18,0	200	100	8,44	3,24	4,31	3,68	3,68	4,31	3	5,60	4,98	
8,0 x 320	18,0	220	100	8,44	3,24	4,31	3,68	3,68	4,31	3	5,60	4,98	
8,0 x 340	18,0	240	100	8,44	3,24	4,31	3,68	3,68	4,31	3	5,60	4,98	
8,0 x 360	18,0	260	100	8,44	3,24	4,31	3,68	3,68	4,31	3	5,60	4,98	
8,0 x 380	18,0	280	100	8,44	3,24	4,31	3,68	3,68	4,31	3	5,60	4,98	
8,0 x 400	18,0	300	100	8,44	3,24	4,31	3,68	3,68	4,31	3	5,60	4,98	
8,0 x 420	18,0	320	100	8,44	3,24	4,31	3,68	3,68	4,31	3	5,60	4,98	
8,0 x 440	18,0	340	100	8,44	3,24	4,31	3,68	3,68	4,31	3	5,60	4,98	
8,0 x 460	18,0	360	100	8,44	3,24	4,31	3,68	3,68	4,31	3	5,60	4,98	
8,0 x 480	18,0	380	100	8,44	3,24	4,31	3,68	3,68	4,31	3	5,60	4,98	
8,0 x 500	18,0	400	100	8,44	3,24	4,31	3,68	3,68	4,31	3	5,60	4,98	
8,0 x 550	18,0	450	100	8,44	3,24	4,31	3,68	3,68	4,31	3	5,60	4,98	
8,0 x 600	18,0	500	100	8,44	3,24	4,31	3,68	3,68	4,31	3	5,60	4,98	

Calculation according to ETA-11/0024. Wood density ρ<sub>k</sub> = 350 kg/m<sup>3</sup>. All mechanical values provided should be viewed as subject to the assumptions that have been made and represent example calculations.

All values are calculated minimum values and are subject to typographical and printing errors.

a) The characteristic values of the load-bearing capacity R<sub>k</sub> cannot be treated as equivalent to the max. possible load (the max. force). Characteristic values of the load-bearing capacity R<sub>k</sub> should be reduced to dimensioning values R<sub>d</sub> with regard to the usage class and class of the load duration: R<sub>d</sub> = R<sub>k</sub> · k<sub>mod</sub> / γ<sub>M</sub>. The dimensioning values of the load-bearing capacity R<sub>d</sub> should be contrasted with the dimensioning values of the loads (R<sub>d</sub> ≥ E<sub>d</sub>).

**Example:**

Characteristic value for constant load (dead weight) G<sub>k</sub> = 2,00 kN and variable load (e. g. snow load) Q<sub>k</sub> = 3,00 kN. k<sub>mod</sub> = 0,9 · γ<sub>M</sub> = 1,3.

→ Dimensioning value of the load E<sub>d</sub> = 2,00 · 1,35 + 3,00 · 1,5 = 7,20 kN.

The load-bearing capacity of the joint is therefore considered to have been demonstrated if R<sub>d</sub> ≥ E<sub>d</sub> → min R<sub>k</sub> = R<sub>d</sub> · γ<sub>M</sub> / k<sub>mod</sub>

i.e. the characteristic minimum value is calculated based on: min R<sub>k</sub> = R<sub>d</sub> · γ<sub>M</sub> / k<sub>mod</sub> → R<sub>k</sub> = 7,20 kN · 1,3/0,9 = 10,40 kN → comparison with table values.

Please note: These are planning aids. Projects must only be calculated by authorised persons.

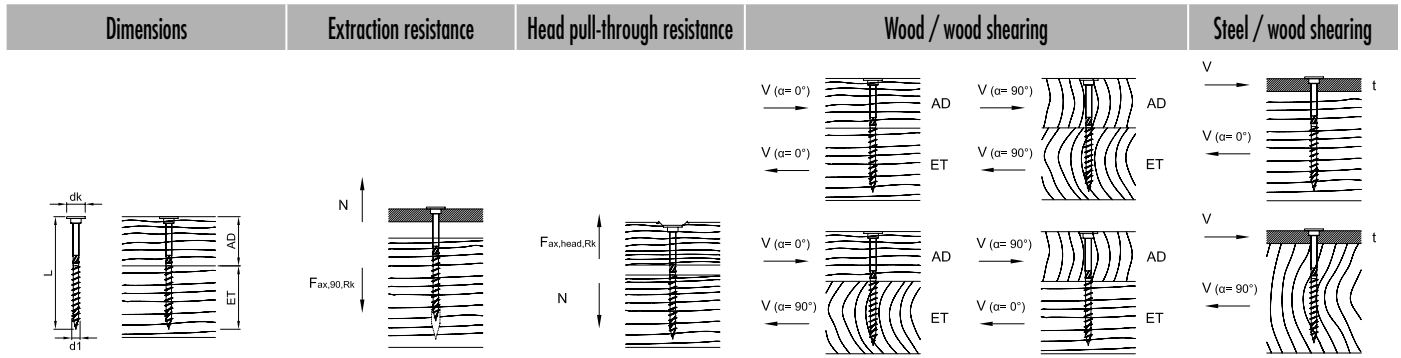

d1 x L [mm]	dk [mm]	AD [mm]	ET [mm]	Fax,90,Rk [kN]	Fax,head,Rk [kN]	F <sub>l0,Rk</sub> [kN]				t [mm]	F <sub>l0,Rk</sub> [kN]	
						α <sub>AD</sub> = 0°		α <sub>AD</sub> = 90°			α = 0°	α = 90°
						α <sub>ET</sub> = 90°	α <sub>ET</sub> = 0°	α = 0°	α = 90°			
10,0 x 100	22,0	40	60	6,48	4,84	6,03	4,67	6,03	4,67	3	6,78	5,81
10,0 x 120	22,0	60	60	6,48	4,84	6,37	5,40	6,37	5,40	3	6,78	5,81
10,0 x 140	22,0	40	100	10,26	4,84	6,03	4,67	6,03	4,67	3	7,72	6,76
10,0 x 160	22,0	60	100	10,26	4,84	6,37	5,40	6,37	5,40	3	7,72	6,76
10,0 x 180	22,0	80	100	10,26	4,84	6,37	5,40	6,37	5,40	3	7,72	6,76
10,0 x 200	22,0	100	100	10,26	4,84	6,37	5,40	5,40	6,37	3	7,72	6,76
10,0 x 220	22,0	120	100	10,26	4,84	6,37	5,40	5,40	6,37	3	7,72	6,76
10,0 x 240	22,0	140	100	10,26	4,84	6,37	5,40	5,40	6,37	3	7,72	6,76
10,0 x 260	22,0	160	100	10,26	4,84	6,37	5,40	5,40	6,37	3	7,72	6,76
10,0 x 280	22,0	180	100	10,26	4,84	6,37	5,40	5,40	6,37	3	7,72	6,76
10,0 x 300	22,0	200	100	10,26	4,84	6,37	5,40	5,40	6,37	3	7,72	6,76
10,0 x 320	22,0	220	100	10,26	4,84	6,37	5,40	5,40	6,37	3	7,72	6,76
10,0 x 340	22,0	240	100	10,26	4,84	6,37	5,40	5,40	6,37	3	7,72	6,76
10,0 x 360	22,0	260	100	10,26	4,84	6,37	5,40	5,40	6,37	3	7,72	6,76
10,0 x 380	22,0	280	100	10,26	4,84	6,37	5,40	5,40	6,37	3	7,72	6,76
10,0 x 400	22,0	300	100	10,26	4,84	6,37	5,40	5,40	6,37	3	7,72	6,76

Calculation according to ETA-11/0024. Wood density ρ<sub>k</sub> = 350 kg/m<sup>3</sup>. All mechanical values provided should be viewed as subject to the assumptions that have been made and represent example calculations.

All values are calculated minimum values and are subject to typographical and printing errors.

a) The characteristic values of the load-bearing capacity R<sub>k</sub> cannot be treated as equivalent to the max. possible load (the max. force). Characteristic values of the load-bearing capacity R<sub>k</sub> should be reduced to dimensioning values R<sub>d</sub> with regard to the usage class and class of the load duration: R<sub>d</sub> = R<sub>k</sub> · k<sub>mod</sub> / γ<sub>M</sub>. The dimensioning values of the load-bearing capacity R<sub>d</sub> should be contrasted with the dimensioning values of the loads (R<sub>d</sub> ≥ E<sub>d</sub>).

**Example:**

Characteristic value for constant load (dead weight) G<sub>k</sub> = 2,00 kN and variable load (e. g. snow load) Q<sub>k</sub> = 3,00 kN. k<sub>mod</sub> = 0,9. γ<sub>M</sub> = 1,3.

→ Dimensioning value of the load E<sub>d</sub> = 2,00 · 1,35 + 3,00 · 1,5 = 7,20 kN.

The load-bearing capacity of the joint is therefore considered to have been demonstrated if R<sub>d</sub> ≥ E<sub>d</sub>. → min R<sub>k</sub> = R<sub>d</sub> · γ<sub>M</sub> / k<sub>mod</sub>

i.e. the characteristic minimum value is calculated based on: min R<sub>k</sub> = R<sub>d</sub> · γ<sub>M</sub> / k<sub>mod</sub> → R<sub>k</sub> = 7,20 kN · 1,3 / 0,9 = 10,40 kN → comparison with table values.

Please note: These are planning aids. Projects must only be calculated by authorised persons.





# Paneltwistec

Yellow/blue galvanised

## Paneltwistec

Countersunk-head screw, blue galvanised



Art. no.	Dimensions [mm]	Drive	PU
8903045	3,5 x 30	TX15 ●	1000
8903044	3,5 x 35	TX15 ●	1000
8903001	3,5 x 40	TX15 ●	1000
8903002	3,5 x 50	TX15 ●	500
8903003	4,0 x 30	TX20 ●	1000
8903603	4,0 x 35	TX20 ●	1000
8903004	4,0 x 40	TX20 ●	1000
8902089	4,0 x 45	TX20 ●	500
8903005	4,0 x 50	TX20 ●	500
8903006	4,0 x 60	TX20 ●	200
8903007	4,0 x 70	TX20 ●	200
8903008	4,0 x 80	TX20 ●	200
8903009	4,5 x 40	TX25 ●	500
8903087	4,5 x 45	TX25 ●	500
8903010	4,5 x 50	TX25 ●	500
8903088	4,5 x 55	TX25 ●	500
8903011	4,5 x 60	TX25 ●	200
8903012	4,5 x 70	TX25 ●	200
8903013	4,5 x 80	TX25 ●	200
8903014	5,0 x 40	TX25 ●	200
8903015	5,0 x 50	TX25 ●	200
8903016	5,0 x 60	TX25 ●	200
8903017	5,0 x 70	TX25 ●	200
8903018	5,0 x 80	TX25 ●	200
8903578	5,0 x 90	TX25 ●	200
8903019	5,0 x 100	TX25 ●	200
8903020	5,0 x 120	TX25 ●	200
8903021	6,0 x 60	TX30 ●	200
8903022	6,0 x 70	TX30 ●	200
8903023	6,0 x 80	TX30 ●	200
8903163	6,0 x 90	TX30 ●	100
8903024	6,0 x 100	TX30 ●	100
8903025	6,0 x 120	TX30 ●	100
8903026	6,0 x 130	TX30 ●	100
8903027	6,0 x 140	TX30 ●	100
8903030	6,0 x 150	TX30 ●	100
8903029	6,0 x 160	TX30 ●	100
8903031	6,0 x 180	TX30 ●	100
8903032	6,0 x 200	TX30 ●	100
8903033	6,0 x 220	TX30 ●	100
8903034	6,0 x 240	TX30 ●	100
8903035	6,0 x 260	TX30 ●	100
8903036	6,0 x 280	TX30 ●	100
8903037	6,0 x 300	TX30 ●	100
975780	12,0 x 120	TX50 ●	25
975781	12,0 x 140	TX50 ●	25
975782	12,0 x 160	TX50 ●	25
975783	12,0 x 180	TX50 ●	25
975784	12,0 x 200	TX50 ●	25
975785	12,0 x 220	TX50 ●	25
975786	12,0 x 240	TX50 ●	25
975787	12,0 x 260	TX50 ●	25
975788	12,0 x 280	TX50 ●	25
975789	12,0 x 300	TX50 ●	25
975790	12,0 x 320	TX50 ●	25
975791	12,0 x 340	TX50 ●	25
975792	12,0 x 360	TX50 ●	25
975793	12,0 x 380	TX50 ●	25
975794	12,0 x 400	TX50 ●	25
975795	12,0 x 500	TX50 ●	25
975796	12,0 x 600	TX50 ●	25

# Technical information

## Paneltwistec, countersunk-head screw, blue galvanised



Dimensions	Extraction resistance	Head pull-through resistance	Wood / wood shearing	Steel / wood shearing
------------	-----------------------	------------------------------	----------------------	-----------------------

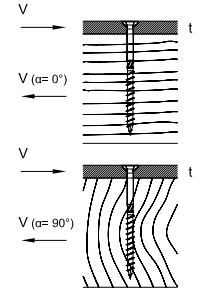
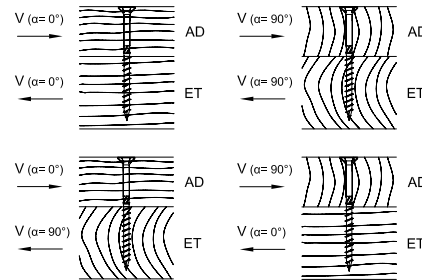
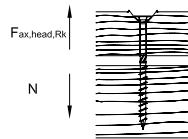
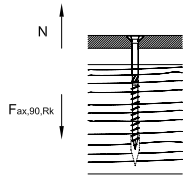
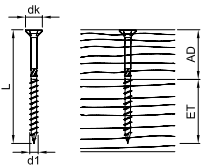

d1 x L [mm]	dk [mm]	AD [mm]	ET [mm]	F <sub>ax,90,Rk</sub> [kN]	F <sub>ax,head,Rk</sub> [kN]	F <sub>lo,Rk</sub> [kN]		F <sub>lo,Rk</sub> [kN]		t [mm]	F <sub>lo,Rk</sub> [kN]	
						alpha = 0°	alpha = 90°	alpha <sub>AD</sub> = 0°	alpha <sub>AD</sub> = 90°		alpha = 0°	alpha = 90°
3,5 x 30	7,0	12	18	0,84	0,59			0,62		1	0,86	
3,5 x 35	7,0	14	21	0,98	0,59			0,67		1	0,92	
3,5 x 40	7,0	16	24	1,12	0,59			0,70		1	0,95	
3,5 x 45	7,0	18	27	1,26	0,59			0,74		1	0,99	
3,5 x 50	7,0	20	30	1,40	0,59			0,78		1	1,02	
4,0 x 30	8,0	12	18	0,93	0,77			0,71		2	0,91	
4,0 x 35	8,0	14	21	1,08	0,77			0,80		2	1,07	
4,0 x 40	8,0	16	24	1,24	0,77			0,84		2	1,15	
4,0 x 45	8,0	18	27	1,39	0,77			0,88		2	1,19	
4,0 x 50	8,0	20	30	1,55	0,77			0,92		2	1,23	
4,0 x 60	8,0	24	36	1,86	0,77			1,01		2	1,31	
4,0 x 70	8,0	28	42	2,17	0,77			1,03		2	1,38	
4,0 x 80	8,0	32	48	2,48	0,77			1,03		2	1,46	
4,5 x 40	9,0	16	24	1,35	0,97			1,00		2	1,34	
4,5 x 45	9,0	18	27	1,52	0,97			1,03		2	1,40	
4,5 x 50	9,0	20	30	1,69	0,97			1,08		2	1,44	
4,5 x 55	9,0	19	36	2,03	0,97			1,05		2	1,53	
4,5 x 60	9,0	24	36	2,03	0,97			1,17		2	1,53	
4,5 x 70	9,0	28	42	2,36	0,97			1,26		2	1,61	
4,5 x 80	9,0	32	48	2,70	0,97			1,26		2	1,70	
5,0 x 40	10,0	16	24	1,45	1,20			1,11		2	1,44	
5,0 x 50	10,0	20	30	1,82	1,20			1,24		2	1,67	
5,0 x 60	10,0	24	36	2,18	1,20			1,34		2	1,76	
5,0 x 70	10,0	28	42	2,54	1,20			1,44		2	1,85	
5,0 x 80	10,0	32	48	2,90	1,20			1,52		2	1,94	
5,0 x 90	10,0	36	54	3,27	1,20			1,52		2	2,03	
5,0 x 100	10,0	40	60	3,63	1,20			1,52		2	2,12	
5,0 x 120	10,0	50	70	4,24	1,20			1,52		2	2,27	

Calculation according to ETA-11/0024. Wood density rho\_k = 350 kg/m³. All mechanical values provided should be viewed as subject to the assumptions that have been made and represent example calculations.

All values are calculated minimum values and are subject to typographical and printing errors.

a) The characteristic values of the load-bearing capacity R\_k cannot be treated as equivalent to the max. possible load (the max. force). Characteristic values of the load-bearing capacity R\_k should be reduced to dimensioning values R\_d with regard to the usage class and class of the load duration: R\_d = R\_k · k\_mod / gamma\_M. The dimensioning values of the load-bearing capacity R\_d should be contrasted with the dimensioning values of the loads (R\_d ≥ E\_d).

### Example:

Characteristic value for constant load (dead weight) G\_k = 2,00 kN and variable load (e. g. snow load) Q\_k = 3,00 kN. k\_mod = 0,9. gamma\_M = 1,3.

→ Dimensioning value of the load E\_d = 2,00 · 1,35 + 3,00 · 1,5 = 7,20 kN.

The load-bearing capacity of the joint is therefore considered to have been demonstrated if R\_d ≥ E\_d. → min R\_d = R\_k · gamma\_M / k\_mod

i.e. the characteristic minimum value is calculated based on: min R\_k = R\_d · k\_mod / gamma\_M → R\_k = 7,20 kN · 1,3 / 0,9 = 10,40 kN → comparison with table values.

Please note: These are planning aids. Projects must only be calculated by authorised persons.

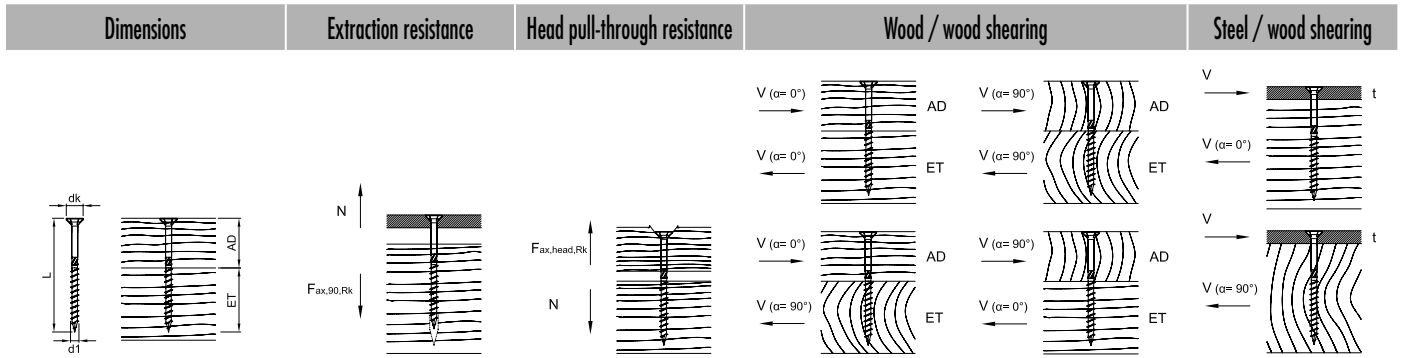

d1 x L [mm]	dk [mm]	AD [mm]	ET [mm]	Fax,90,Rk [kN]	Fax,head,Rk [kN]	Wood / wood shearing				Steel / wood shearing	
						Flo,Rk [kN]	Flo,Rk [kN]	Flo,Rk [kN]	Flo,Rk [kN]	t [mm]	Flo,Rk [kN]
						alpha = 0°	alpha = 90°	alpha_AD = 0°	alpha_AD = 90°		
								alpha_ET = 90°	alpha_ET = 0°	alpha = 0°	alpha = 90°
6,0 x 60	12,0	24	36	2,46	1,73			1,71		2	2,26
6,0 x 70	12,0	28	42	2,87	1,73			1,82		2	2,36
6,0 x 80	12,0	32	48	3,28	1,73			1,93		2	2,46
6,0 x 90	12,0	36	54	3,69	1,73			2,05		2	2,57
6,0 x 100	12,0	40	60	4,10	1,73			2,07		2	2,67
6,0 x 110	12,0	40	70	4,79	1,73			2,07		2	2,84
6,0 x 120	12,0	50	70	4,79	1,73			2,07		2	2,84
6,0 x 130	12,0	60	70	4,79	1,73			2,07		2	2,84
6,0 x 140	12,0	70	70	4,79	1,73			2,07		2	2,84
6,0 x 150	12,0	80	70	4,79	1,73			2,07		2	2,84
6,0 x 160	12,0	90	70	4,79	1,73			2,07		2	2,84
6,0 x 180	12,0	110	70	4,79	1,73			2,07		2	2,84
6,0 x 200	12,0	130	70	4,79	1,73			2,07		2	2,84
6,0 x 220	12,0	150	70	4,79	1,73			2,07		2	2,84
6,0 x 240	12,0	170	70	4,79	1,73			2,07		2	2,84
6,0 x 260	12,0	190	70	4,79	1,73			2,07		2	2,84
6,0 x 280	12,0	210	70	4,79	1,73			2,07		2	2,84
6,0 x 300	12,0	230	70	4,79	1,73			2,07		2	2,84

Calculation according to ETA-11/0024. Wood density  $\rho_k = 350 \text{ kg/m}^3$ . All mechanical values provided should be viewed as subject to the assumptions that have been made and represent example calculations.

All values are calculated minimum values and are subject to typographical and printing errors.

a) The characteristic values of the load-bearing capacity  $R_k$  cannot be treated as equivalent to the max. possible load (the max. force). Characteristic values of the load-bearing capacity  $R_k$  should be reduced to dimensioning values  $R_d$  with regard to the usage class and class of the load duration:  $R_d = R_k \cdot k_{mod} / \gamma_M$ . The dimensioning values of the load-bearing capacity  $R_d$  should be contrasted with the dimensioning values of the loads ( $R_d \geq E_d$ ).

#### Example:

Characteristic value for constant load (dead weight)  $G_k = 2,00 \text{ kN}$  and variable load (e. g. snow load)  $Q_k = 3,00 \text{ kN}$ .  $k_{mod} = 0,9$ ,  $\gamma_M = 1,3$ .

→ Dimensioning value of the load  $E_d = 2,00 \cdot 1,35 + 3,00 \cdot 1,5 = 7,20 \text{ kN}$ .

The load-bearing capacity of the joint is therefore considered to have been demonstrated if  $R_d \geq E_d$ . →  $\min R_k = R_d \cdot \gamma_M / k_{mod}$

i.e. the characteristic minimum value is calculated based on:  $\min R_k = R_d \cdot \gamma_M / k_{mod} \rightarrow R_k = 7,20 \text{ kN} \cdot 1,3 / 0,9 = 10,40 \text{ kN}$  → comparison with table values.

Please note: These are planning aids. Projects must only be calculated by authorised persons.

## Paneltwistec

Countersunk-head screw, yellow galvanised



- Also suitable for fastening over-rafter insulation



Art. no.	Dimensions [mm]	Drive	PU
903000	3,5 x 30	TX20 ●	1000
903044	3,5 x 35	TX20 ●	1000
903001	3,5 x 40	TX20 ●	1000
903002	3,5 x 50	TX20 ●	500
903003	4,0 x 30	TX20 ●	1000
903603	4,0 x 35	TX20 ●	1000
903004	4,0 x 40	TX20 ●	1000
902089	4,0 x 45	TX20 ●	500
903005	4,0 x 50	TX20 ●	500
903006	4,0 x 60	TX20 ●	200
903007	4,0 x 70	TX20 ●	200
903008	4,0 x 80	TX20 ●	200
903046	4,5 x 35	TX20 ●	500
903009	4,5 x 40	TX20 ●	500
903087	4,5 x 45	TX20 ●	500
903010	4,5 x 50	TX20 ●	500
903011	4,5 x 60	TX20 ●	200
903012	4,5 x 70	TX20 ●	200
903013	4,5 x 80	TX20 ●	200
903014	5,0 x 40	TX20 ●	200
903015	5,0 x 50	TX20 ●	200
903016	5,0 x 60	TX20 ●	200
903017	5,0 x 70	TX20 ●	200
903018	5,0 x 80	TX20 ●	200
903578	5,0 x 90	TX20 ●	200
903019	5,0 x 100	TX20 ●	200
903020	5,0 x 120	TX20 ●	200
903071	5,0 x 40	TX25 ●	200
903072	5,0 x 50	TX25 ●	200
903073	5,0 x 60	TX25 ●	200
903074	5,0 x 70	TX25 ●	200
903075	5,0 x 80	TX25 ●	200
903582	5,0 x 90	TX25 ●	200
903076	5,0 x 100	TX25 ●	200
903077	5,0 x 120	TX25 ●	200
903021	6,0 x 60	TX30 ●	200
903022	6,0 x 70	TX30 ●	200
903023	6,0 x 80	TX30 ●	200
903163	6,0 x 90	TX30 ●	100
903024	6,0 x 100	TX30 ●	100
903039	6,0 x 110	TX30 ●	100
903025	6,0 x 120	TX30 ●	100
903026	6,0 x 130	TX30 ●	100
903027	6,0 x 140	TX30 ●	100
903028	6,0 x 150	TX30 ●	100
903029	6,0 x 160	TX30 ●	100
903031	6,0 x 180	TX30 ●	100
903032	6,0 x 200	TX30 ●	100
903033	6,0 x 220	TX30 ●	100
903034	6,0 x 240	TX30 ●	100
903035	6,0 x 260	TX30 ●	100
903036	6,0 x 280	TX30 ●	100
903037	6,0 x 300	TX30 ●	100
903550	8,0 x 80	TX40 ●	50
903551	8,0 x 100	TX40 ●	50
902920	8,0 x 120	TX40 ●	50
902919	8,0 x 140	TX40 ●	50
902921	8,0 x 160	TX40 ●	50
902922	8,0 x 180	TX40 ●	50
902923	8,0 x 200	TX40 ●	50
902924	8,0 x 220	TX40 ●	50
902925	8,0 x 240	TX40 ●	50
902926	8,0 x 260	TX40 ●	50

More sizes on the next page



Art. no.	Dimensions [mm]	Drive	PU
902927	8,0 x 280	TX40 ●	50
902928	8,0 x 300	TX40 ●	50
902929	8,0 x 320	TX40 ●	50
902930	8,0 x 340	TX40 ●	50
902931	8,0 x 360	TX40 ●	50
902932	8,0 x 380	TX40 ●	50
903030	8,0 x 400	TX40 ●	50
903513	10,0 x 100	TX50 ●	50
903491	10,0 x 120	TX50 ●	50
903492	10,0 x 140	TX50 ●	50
903493	10,0 x 160	TX50 ●	50
903494	10,0 x 180	TX50 ●	50
903495	10,0 x 200	TX50 ●	50
903496	10,0 x 220	TX50 ●	50
903497	10,0 x 240	TX50 ●	50
903498	10,0 x 260	TX50 ●	50
903499	10,0 x 280	TX50 ●	50
903500	10,0 x 300	TX50 ●	50
903501	10,0 x 320	TX50 ●	50
903502	10,0 x 340	TX50 ●	50
903503	10,0 x 360	TX50 ●	50
903504	10,0 x 380	TX50 ●	50
903505	10,0 x 400	TX50 ●	50

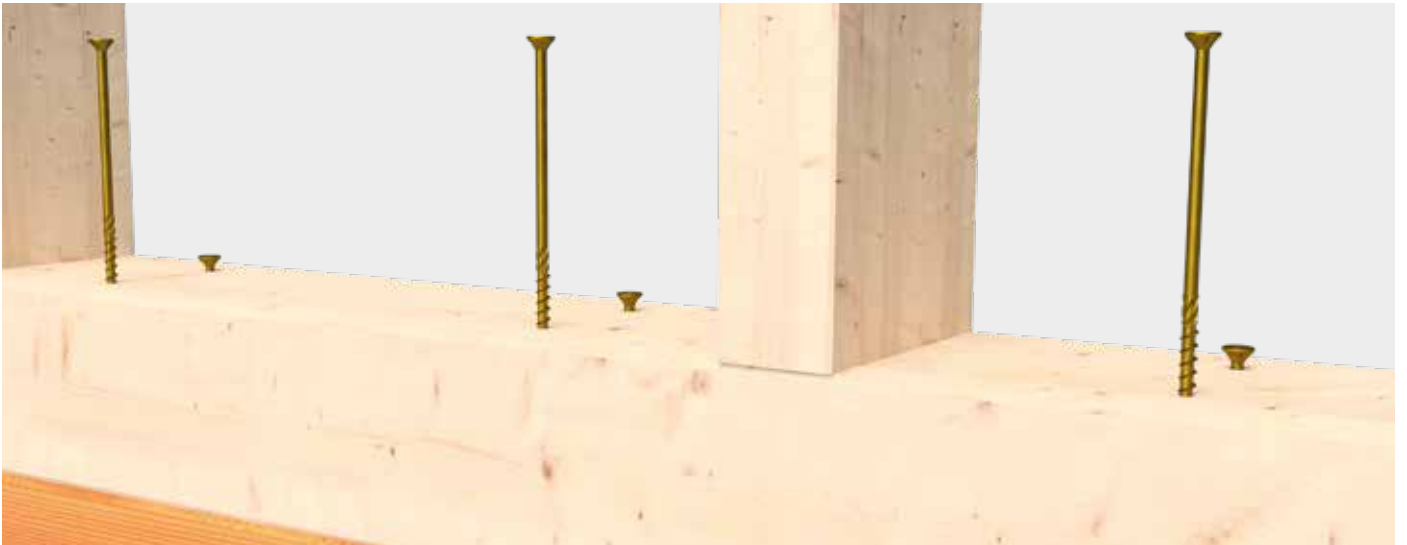

# Technical information

## Paneltwistec, countersunk-head screw, yellow galvanised

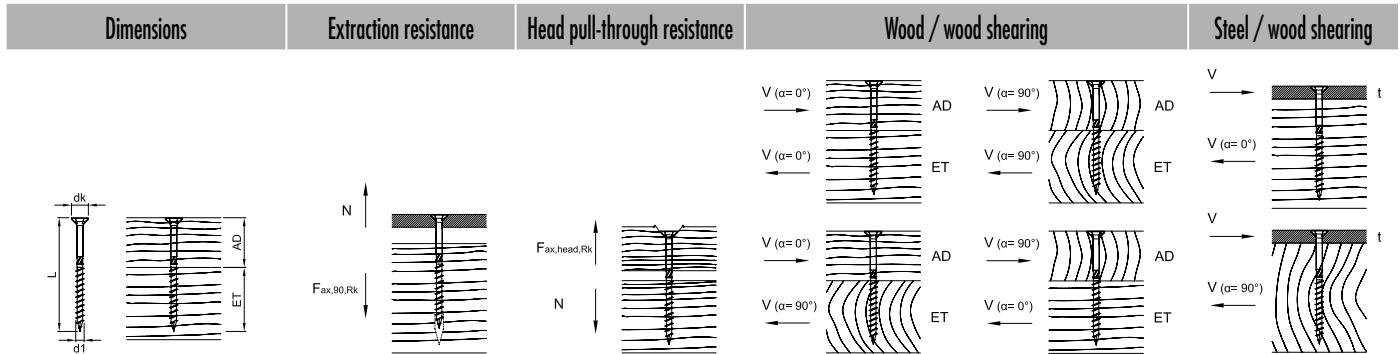

d1 x L [mm]	dk [mm]	AD [mm]	ET [mm]	F <sub>ax,90,Rk</sub> [kN]	F <sub>ax,head,Rk</sub> [kN]	F <sub>lo,Rk</sub> [kN]		F <sub>lo,Rk</sub> [kN]		t [mm]	F <sub>lo,Rk</sub> [kN]	
						α = 0°	α = 90°	α <sub>AD</sub> = 90°	α <sub>ET</sub> = 0°		α = 0°	α = 90°
3,5 x 30	7,0	12	18	0,84	0,59			0,62		1	0,86	
3,5 x 35	7,0	14	21	0,98	0,59			0,67		1	0,92	
3,5 x 40	7,0	16	24	1,12	0,59			0,70		1	0,95	
3,5 x 45	7,0	18	27	1,26	0,59			0,74		1	0,99	
3,5 x 50	7,0	20	30	1,40	0,59			0,78		1	1,02	
4,0 x 30	8,0	12	18	0,93	0,77			0,71		2	0,91	
4,0 x 35	8,0	14	21	1,08	0,77			0,80		2	1,07	
4,0 x 40	8,0	16	24	1,24	0,77			0,84		2	1,15	
4,0 x 45	8,0	18	27	1,39	0,77			0,88		2	1,19	
4,0 x 50	8,0	20	30	1,55	0,77			0,92		2	1,23	
4,0 x 60	8,0	24	36	1,86	0,77			1,01		2	1,31	
4,0 x 70	8,0	28	42	2,17	0,77			1,03		2	1,38	
4,0 x 80	8,0	32	48	2,48	0,77			1,03		2	1,46	
4,5 x 35	9,0	14	21	1,18	0,97			0,90		2	1,32	
4,5 x 40	9,0	16	24	1,35	0,97			1,00		2	1,34	
4,5 x 45	9,0	18	27	1,52	0,97			1,03		2	1,40	
4,5 x 50	9,0	20	30	1,69	0,97			1,08		2	1,44	
4,5 x 60	9,0	24	36	2,03	0,97			1,17		2	1,53	
4,5 x 70	9,0	28	42	2,36	0,97			1,26		2	1,61	
4,5 x 80	9,0	32	48	2,70	0,97			1,26		2	1,70	
5,0 x 40*	10,0	16	24	1,45	1,20			1,11		2	1,44	
5,0 x 50*	10,0	20	30	1,82	1,20			1,24		2	1,67	
5,0 x 60*	10,0	24	36	2,18	1,20			1,34		2	1,76	
5,0 x 70*	10,0	28	42	2,54	1,20			1,44		2	1,85	
5,0 x 80*	10,0	32	48	2,90	1,20			1,52		2	1,94	
5,0 x 90*	10,0	36	54	3,27	1,20			1,52		2	2,03	
5,0 x 100*	10,0	40	60	3,63	1,20			1,52		2	2,12	
5,0 x 120*	10,0	50	70	4,24	1,20			1,52		2	2,27	

Calculation according to ETA-11/0024. Wood density ρ<sub>k</sub> = 350 kg/m<sup>3</sup>. All mechanical values provided should be viewed as subject to the assumptions that have been made and represent example calculations.

All values are calculated minimum values and are subject to typographical and printing errors.

a) The characteristic values of the load-bearing capacity R<sub>k</sub> cannot be treated as equivalent to the max. possible load (the max. force). Characteristic values of the load-bearing capacity R<sub>k</sub> should be reduced to dimensioning values R<sub>d</sub> with regard to the usage class and class of the load duration: R<sub>d</sub> = R<sub>k</sub> · k<sub>mod</sub> / γ<sub>M</sub>. The dimensioning values of the load-bearing capacity R<sub>d</sub> should be contrasted with the dimensioning values of the loads (R<sub>d</sub> ≥ E<sub>d</sub>).

### Example:

Characteristic value for constant load (dead weight) G<sub>k</sub> = 2,00 kN and variable load (e. g. snow load) Q<sub>k</sub> = 3,00 kN. k<sub>mod</sub> = 0,9. γ<sub>M</sub> = 1,3.

→ Dimensioning value of the load E<sub>d</sub> = 2,00 · 1,35 + 3,00 · 1,5 = 7,20 kN.

The load-bearing capacity of the joint is therefore considered to have been demonstrated if R<sub>d</sub> ≥ E<sub>d</sub>. → min R<sub>d</sub> = R<sub>k</sub> · γ<sub>M</sub> / k<sub>mod</sub>

i.e. the characteristic minimum value is calculated based on: min R<sub>k</sub> = R<sub>d</sub> · γ<sub>M</sub> / k<sub>mod</sub> → R<sub>k</sub> = 7,20 kN · 1,3 / 0,9 = 10,40 kN → comparison with table values.

Please note: These are planning aids. Projects must only be calculated by authorised persons.

\*Applies to TX20 and TX25

Dimensions	Extraction resistance	Head pull-through resistance	Wood / wood shearing	Steel / wood shearing
------------	-----------------------	------------------------------	----------------------	-----------------------

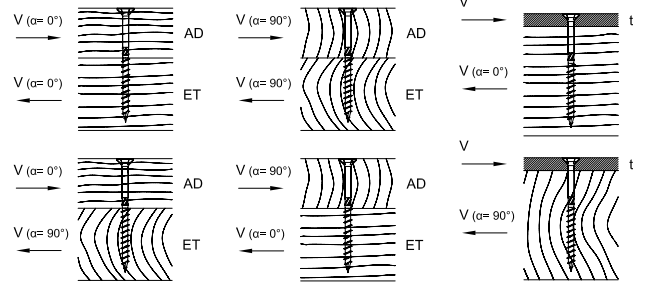
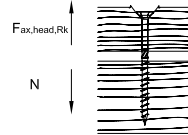
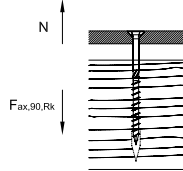
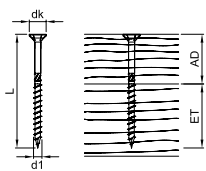

d1 x L [mm]	dk [mm]	AD [mm]	ET [mm]	F <sub>ax,90,Rk</sub> [kN]	F <sub>ax,head,Rk</sub> [kN]	F <sub>lo,Rk</sub> [kN]				t [mm]	F <sub>lo,Rk</sub> [kN]	
						alpha = 0°		alpha = 90°			alpha = 0°	alpha = 90°
								alpha <sub>AD</sub> = 0°	alpha <sub>AD</sub> = 90°			
						alpha = 0°	alpha = 90°	alpha <sub>ET</sub> = 90°	alpha <sub>ET</sub> = 0°	alpha = 0°	alpha = 90°	
6,0 x 60	12,0	24	36	2,46	1,73			1,71		2	2,26	
6,0 x 70	12,0	28	42	2,87	1,73			1,82		2	2,36	
6,0 x 80	12,0	32	48	3,28	1,73			1,93		2	2,46	
6,0 x 90	12,0	36	54	3,69	1,73			2,05		2	2,57	
6,0 x 100	12,0	40	60	4,10	1,73			2,07		2	2,67	
6,0 x 110	12,0	40	70	4,79	1,73			2,07		2	2,84	
6,0 x 120	12,0	50	70	4,79	1,73			2,07		2	2,84	
6,0 x 130	12,0	60	70	4,79	1,73			2,07		2	2,84	
6,0 x 140	12,0	70	70	4,79	1,73			2,07		2	2,84	
6,0 x 150	12,0	80	70	4,79	1,73			2,07		2	2,84	
6,0 x 160	12,0	90	70	4,79	1,73			2,07		2	2,84	
6,0 x 180	12,0	110	70	4,79	1,73			2,07		2	2,84	
6,0 x 200	12,0	130	70	4,79	1,73			2,07		2	2,84	
6,0 x 220	12,0	150	70	4,79	1,73			2,07		2	2,84	
6,0 x 240	12,0	170	70	4,79	1,73			2,07		2	2,84	
6,0 x 260	12,0	190	70	4,79	1,73			2,07		2	2,84	
6,0 x 280	12,0	210	70	4,79	1,73			2,07		2	2,84	
6,0 x 300	12,0	230	70	4,79	1,73			2,07		2	2,84	
8,0 x 80	14,5	30	50	4,26	2,52	3,71	2,90	3,71	2,90	3	4,56	3,94
8,0 x 100	14,5	40	60	5,33	2,52	4,13	3,30	4,13	3,30	3	4,83	4,20
8,0 x 120	14,5	40	80	7,10	2,52	4,13	3,30	4,13	3,30	3	5,27	4,65
8,0 x 140	14,5	60	80	7,10	2,52	4,13	3,50	4,13	3,50	3	5,27	4,65
8,0 x 160	14,5	80	80	7,10	2,52	4,13	3,50	4,13	3,50	3	5,27	4,65
8,0 x 180	14,5	100	80	7,10	2,52	4,13	3,50	3,50	4,13	3	5,27	4,65
8,0 x 200	14,5	120	80	7,10	2,52	4,13	3,50	3,50	4,13	3	5,27	4,65
8,0 x 220	14,5	140	80	7,10	2,52	4,13	3,50	3,50	4,13	3	5,27	4,65
8,0 x 240	14,5	160	80	7,10	2,52	4,13	3,50	3,50	4,13	3	5,27	4,65
8,0 x 260	14,5	180	80	7,10	2,52	4,13	3,50	3,50	4,13	3	5,27	4,65
8,0 x 280	14,5	200	80	7,10	2,52	4,13	3,50	3,50	4,13	3	5,27	4,65
8,0 x 300	14,5	220	80	7,10	2,52	4,13	3,50	3,50	4,13	3	5,27	4,65
8,0 x 320	14,5	240	80	7,10	2,52	4,13	3,50	3,50	4,13	3	5,27	4,65
8,0 x 340	14,5	260	80	7,10	2,52	4,13	3,50	3,50	4,13	3	5,27	4,65
8,0 x 360	14,5	280	80	7,10	2,52	4,13	3,50	3,50	4,13	3	5,27	4,65
8,0 x 380	14,5	300	80	7,10	2,52	4,13	3,50	3,50	4,13	3	5,27	4,65
8,0 x 400	14,5	320	80	7,10	2,52	4,13	3,50	3,50	4,13	3	5,27	4,65

Calculation according to ETA-11/0024. Wood density rho\_k = 350 kg/m³. All mechanical values provided should be viewed as subject to the assumptions that have been made and represent example calculations.

All values are calculated minimum values and are subject to typographical and printing errors.

a) The characteristic values of the load-bearing capacity R\_k cannot be treated as equivalent to the max. possible load (the max. force). Characteristic values of the load-bearing capacity R\_k should be reduced to dimensioning values R\_d with regard to the usage class and class of the load duration: R\_d = R\_k · k\_mod / gamma\_M. The dimensioning values of the load-bearing capacity R\_d should be contrasted with the dimensioning values of the loads (R\_d ≥ E\_d).

**Example:**

Characteristic value for constant load (dead weight) G\_k = 2,00 kN and variable load (e. g. snow load) Q\_k = 3,00 kN. k\_mod = 0,9. gamma\_M = 1,3.

→ Dimensioning value of the load E\_d = 2,00 · 1,35 + 3,00 · 1,5 = 7,20 kN.

The load-bearing capacity of the joint is therefore considered to have been demonstrated if R\_d ≥ E\_d. → min R\_k = R\_d · gamma\_M / k\_mod

i.e. the characteristic minimum value is calculated based on: min R\_k = R\_d · gamma\_M / k\_mod → R\_k = 7,20 kN · 1,3 / 0,9 = 10,40 kN → comparison with table values.

Please note: These are planning aids. Projects must only be calculated by authorised persons.

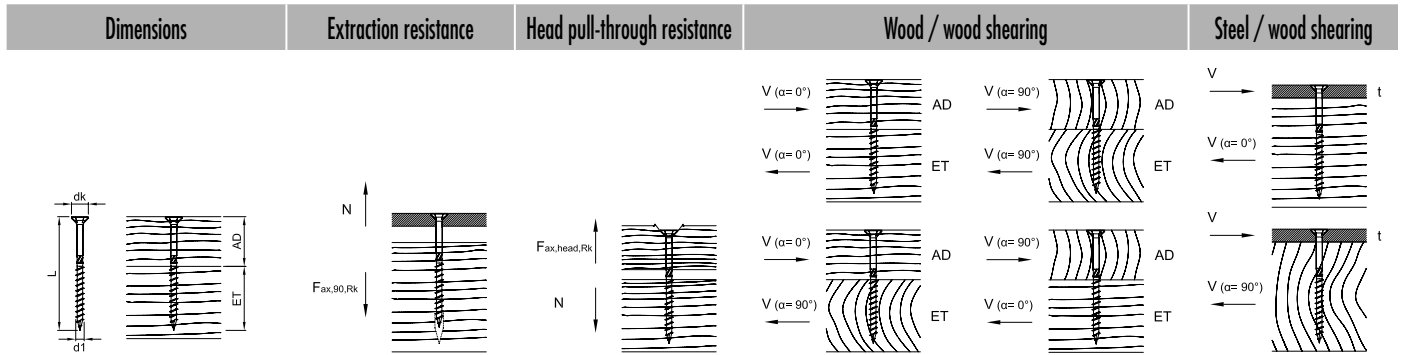

d1 x L [mm]	dk [mm]	AD [mm]	ET [mm]	Fax,90,Rk [kN]	Fax,head,Rk [kN]	F <sub>l0,Rk</sub> [kN]		F <sub>l0,Rk</sub> [kN]		t [mm]	F <sub>l0,Rk</sub> [kN]	
						alpha = 0°	alpha = 90°	alpha <sub>AD</sub> = 0°	alpha <sub>AD</sub> = 90°		alpha = 0°	alpha = 90°
10,0 x 100	17,4	40	60	6,48	3,63	5,73	4,37	5,73	4,37	3	6,78	5,81
10,0 x 120	17,4	20	100	9,72	3,63	4,44	3,67	3,71	3,67	3	7,59	6,62
10,0 x 140	17,4	40	100	9,72	3,63	5,73	4,37	5,73	4,37	3	7,59	6,62
10,0 x 160	17,4	60	100	9,72	3,63	6,07	5,10	6,07	5,10	3	7,59	6,62
10,0 x 180	17,4	80	100	9,72	3,63	6,07	5,10	6,07	5,10	3	7,59	6,62
10,0 x 200	17,4	100	100	9,72	3,63	6,07	5,10	5,10	6,07	3	7,59	6,62
10,0 x 220	17,4	120	100	9,72	3,63	6,07	5,10	5,10	6,07	3	7,59	6,62
10,0 x 240	17,4	140	100	9,72	3,63	6,07	5,10	5,10	6,07	3	7,59	6,62
10,0 x 260	17,4	160	100	9,72	3,63	6,07	5,10	5,10	6,07	3	7,59	6,62
10,0 x 280	17,4	180	100	9,72	3,63	6,07	5,10	5,10	6,07	3	7,59	6,62
10,0 x 300	17,4	200	100	9,72	3,63	6,07	5,10	5,10	6,07	3	7,59	6,62
10,0 x 320	17,4	220	100	9,72	3,63	6,07	5,10	5,10	6,07	3	7,59	6,62
10,0 x 340	17,4	240	100	9,72	3,63	6,07	5,10	5,10	6,07	3	7,59	6,62
10,0 x 360	17,4	260	100	9,72	3,63	6,07	5,10	5,10	6,07	3	7,59	6,62
10,0 x 380	17,4	280	100	9,72	3,63	6,07	5,10	5,10	6,07	3	7,59	6,62
10,0 x 400	17,4	300	100	9,72	3,63	6,07	5,10	5,10	6,07	3	7,59	6,62

Calculation according to ETA-11/0024. Wood density ρ<sub>k</sub> = 350 kg/m<sup>3</sup>. All mechanical values provided should be viewed as subject to the assumptions that have been made and represent example calculations.

All values are calculated minimum values and are subject to typographical and printing errors.

a) The characteristic values of the load-bearing capacity R<sub>k</sub> cannot be treated as equivalent to the max. possible load (the max. force). Characteristic values of the load-bearing capacity R<sub>k</sub> should be reduced to dimensioning values R<sub>d</sub> with regard to the usage class and class of the load duration: R<sub>d</sub> = R<sub>k</sub> · k<sub>mod</sub> / γ<sub>M</sub>. The dimensioning values of the load-bearing capacity R<sub>d</sub> should be contrasted with the dimensioning values of the loads (R<sub>d</sub> ≥ E<sub>d</sub>).

**Example:**

Characteristic value for constant load (dead weight) G<sub>k</sub> = 2,00 kN and variable load (e. g. snow load) Q<sub>k</sub> = 3,00 kN. k<sub>mod</sub> = 0,9, γ<sub>M</sub> = 1,3.

→ Dimensioning value of the load E<sub>d</sub> = 2,00 · 1,35 + 3,00 · 1,5 = 7,20 kN.

The load-bearing capacity of the joint is therefore considered to have been demonstrated if R<sub>d</sub> ≥ E<sub>d</sub>. → min R<sub>k</sub> = R<sub>d</sub> · γ<sub>M</sub> / k<sub>mod</sub>

i.e. the characteristic minimum value is calculated based on: min R<sub>k</sub> = R<sub>d</sub> · γ<sub>M</sub> / k<sub>mod</sub> → R<sub>k</sub> = 7,20 kN · 1,3 / 0,9 = 10,40 kN → comparison with table values.

Please note: These are planning aids. Projects must only be calculated by authorised persons.



## Paneltwistec

Flanged button-head screw, yellow galvanised



- Also suitable for fastening over-rafter insulation
- The larger head diameter allows for considerably higher torque and head pull-through capacity
- Better use of the screw's tensile load bearing strength



Art. no.	Dimensions [mm]	Drive	PU
G903204	8,0 x 80	TX40 ●	50
G903205	8,0 x 100	TX40 ●	50
G903466	8,0 x 120	TX40 ●	50
G903467	8,0 x 140	TX40 ●	50
G903468	8,0 x 160	TX40 ●	50
G903469	8,0 x 180	TX40 ●	50
G903470	8,0 x 200	TX40 ●	50
G903471	8,0 x 220	TX40 ●	50
G903472	8,0 x 240	TX40 ●	50
G903473	8,0 x 260	TX40 ●	50
G903474	8,0 x 280	TX40 ●	50
G903475	8,0 x 300	TX40 ●	50
G903476	8,0 x 320	TX40 ●	50
G903477	8,0 x 340	TX40 ●	50
G903478	8,0 x 360	TX40 ●	50
G904625	8,0 x 380	TX40 ●	50
G904626	8,0 x 400	TX40 ●	50

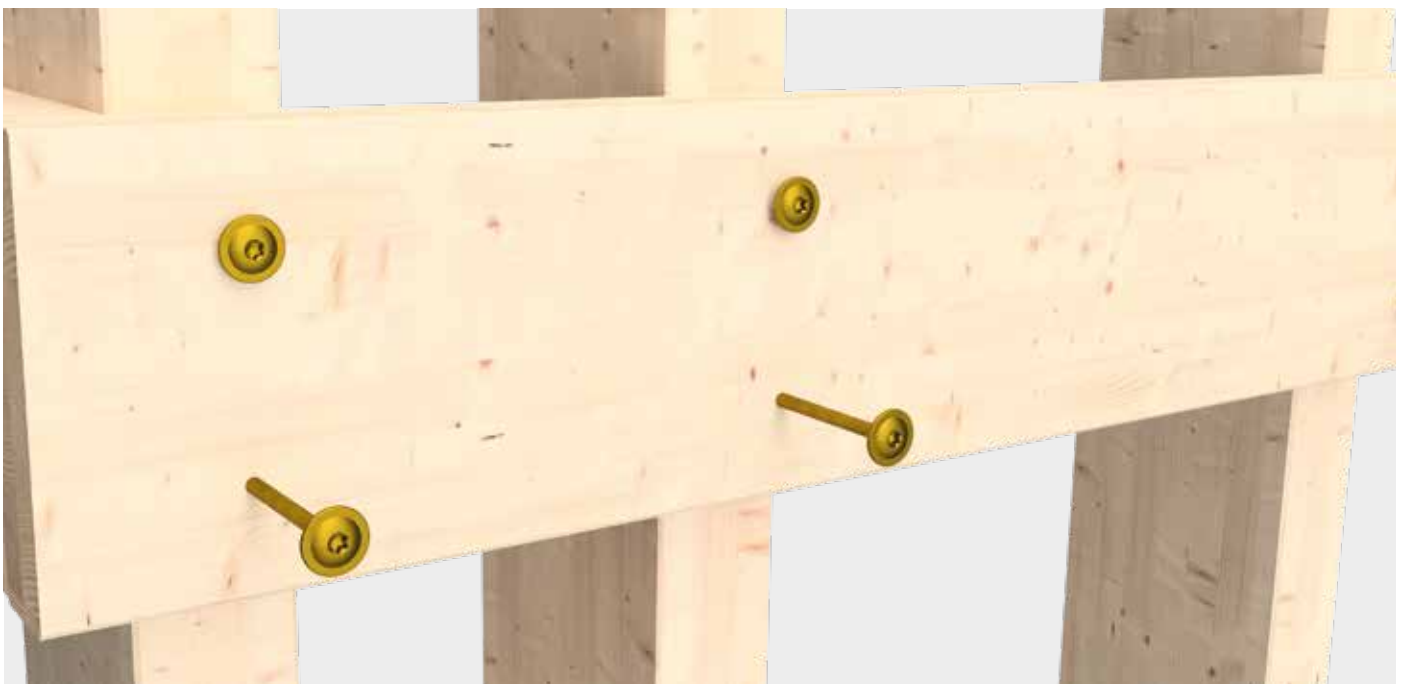

# Technical information

## Paneltwistec, flanged button-head screw, yellow galvanised

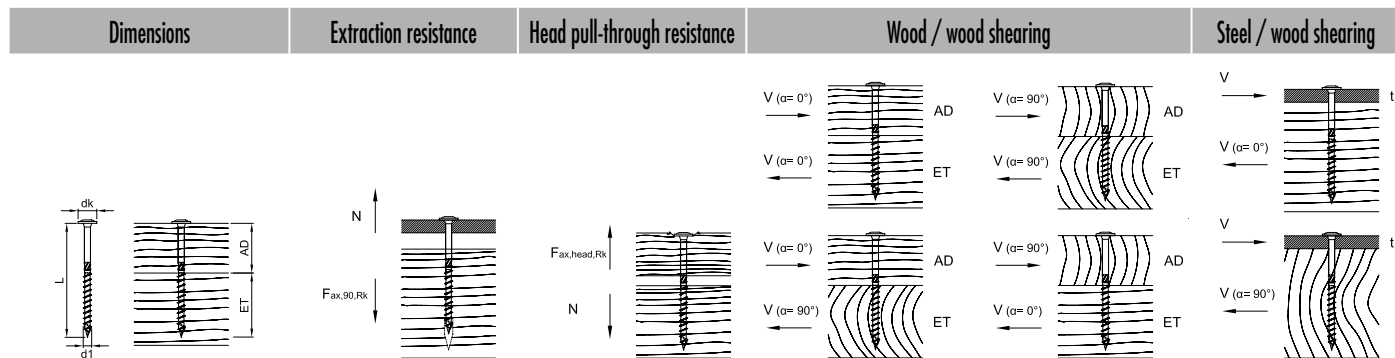

d1 x L [mm]	dk [mm]	AD [mm]	ET [mm]	F <sub>α,90,Rk</sub> [kN]	F <sub>α,head,Rk</sub> [kN]	Wood / wood shearing				Steel / wood shearing		
						F <sub>10,Rk</sub> [kN]	F <sub>10,Rk</sub> [kN]	F <sub>10,Rk</sub> [kN]	F <sub>10,Rk</sub> [kN]	t [mm]	F <sub>10,Rk</sub> [kN]	F <sub>10,Rk</sub> [kN]
						α = 0°		α <sub>AD</sub> = 0°				
						α = 0°	α = 90°	α <sub>ET</sub> = 90°	α <sub>ET</sub> = 0°		α = 0°	α = 90°
8,0 x 80	22,0	30	50	4,26	5,81	4,27	3,41	4,27	3,41	3	4,56	3,94
8,0 x 100	22,0	40	60	5,33	5,81	4,83	4,01	4,83	4,01	3	4,83	4,20
8,0 x 120	22,0	40	80	7,10	5,81	4,95	4,13	4,95	4,13	3	5,27	4,65
8,0 x 140	22,0	60	80	7,10	5,81	4,95	4,32	4,95	4,32	3	5,27	4,65
8,0 x 160	22,0	80	80	7,10	5,81	4,95	4,32	4,95	4,32	3	5,27	4,65
8,0 x 180	22,0	100	80	7,10	5,81	4,95	4,32	4,32	4,95	3	5,27	4,65
8,0 x 200	22,0	120	80	7,10	5,81	4,95	4,32	4,32	4,95	3	5,27	4,65
8,0 x 220	22,0	140	80	7,10	5,81	4,95	4,32	4,32	4,95	3	5,27	4,65
8,0 x 240	22,0	160	80	7,10	5,81	4,95	4,32	4,32	4,95	3	5,27	4,65
8,0 x 260	22,0	180	80	7,10	5,81	4,95	4,32	4,32	4,95	3	5,27	4,65
8,0 x 280	22,0	200	80	7,10	5,81	4,95	4,32	4,32	4,95	3	5,27	4,65
8,0 x 300	22,0	220	80	7,10	5,81	4,95	4,32	4,32	4,95	3	5,27	4,65
8,0 x 320	22,0	240	80	7,10	5,81	4,95	4,32	4,32	4,95	3	5,27	4,65
8,0 x 340	22,0	260	80	7,10	5,81	4,95	4,32	4,32	4,95	3	5,27	4,65
8,0 x 360	22,0	280	80	7,10	5,81	4,95	4,32	4,32	4,95	3	5,27	4,65
8,0 x 380	22,0	300	80	7,10	5,81	4,95	4,32	4,32	4,95	3	5,27	4,65
8,0 x 400	22,0	320	80	7,10	5,81	4,95	4,32	4,32	4,95	3	5,27	4,65

Calculation according to ETA-11/0024. Wood density ρ<sub>W</sub> = 350 kg/m<sup>3</sup>. All mechanical values provided should be viewed as subject to the assumptions that have been made and represent example calculations.

All values are calculated minimum values and are subject to typographical and printing errors.

a) The characteristic values of the load-bearing capacity R<sub>k</sub> cannot be treated as equivalent to the max. possible load (the max. force). Characteristic values of the load-bearing capacity R<sub>k</sub> should be reduced to dimensioning values R<sub>d</sub> with regard to the usage class and class of the load duration: R<sub>d</sub> = R<sub>k</sub> · k<sub>mod</sub> / γ<sub>M</sub>. The dimensioning values of the load-bearing capacity R<sub>d</sub> should be contrasted with the dimensioning values of the loads (R<sub>d</sub> ≥ E<sub>d</sub>).

### Example:

Characteristic value for constant load (dead weight) G<sub>k</sub> = 2,00 kN and variable load (e. g. snow load) Q<sub>k</sub> = 3,00 kN. k<sub>mod</sub> = 0,9. γ<sub>M</sub> = 1,3.

→ Dimensioning value of the load E<sub>d</sub> = 2,00 · 1,35 + 3,00 · 1,5 = 7,20 kN.

The load-bearing capacity of the joint is therefore considered to have been demonstrated if R<sub>d</sub> ≥ E<sub>d</sub>. → min R<sub>d</sub> = R<sub>k</sub> · γ<sub>M</sub> / k<sub>mod</sub>

i.e. the characteristic minimum value is calculated based on: min R<sub>k</sub> = R<sub>d</sub> · γ<sub>M</sub> / k<sub>mod</sub> → R<sub>k</sub> = 7,20 kN · 1,3 / 0,9 = 10,40 kN → comparison with table values.

Please note: These are planning aids. Projects must only be calculated by authorised persons.



# Screws in magazine

Holzher system

## Paneltwistec

Magazine, blue galvanised



Art. no.	Dimensions [mm]	Thread length [mm]	Drive	Pieces/belt	Coils/carton
905613	4,0 x 40	24	TX20 ●	167	12
905614	4,0 x 50	30	TX20 ●	167	12
905615	4,0 x 60	36	TX20 ●	167	12
905616	4,5 x 50	30	TX25 ●	125	12
905617	4,5 x 60	36	TX25 ●	125	12
905622	4,5 x 70	42	TX25 ●	125	5
905635	5,0 x 50	30	TX25 ●	125	10
905636	5,0 x 60	36	TX25 ●	125	10
905637	5,0 x 70	42	TX25 ●	125	5
905643	5,0 x 80	48	TX25 ●	125	5

## Paneltwistec

Magazine, hardened stainless steel



Art. no.	Dimensions [mm]	Thread length [mm]	Drive	Pieces/belt	Coils/carton
903605	4,5 x 50	30	TX25 ●	125	12
903606	4,5 x 60	36	TX25 ●	125	12
903612	5,0 x 60	36	TX25 ●	125	5
903609	5,0 x 70	42	TX25 ●	125	5
903608	5,0 x 80	48	TX25 ●	125	10

### Field of application for hardened stainless-steel screws

- This steel combines the best properties of carbon steels and stainless steels. It is partially rust-resistant like an A2 but with the high mechanical values of a galvanised steel. Hardened stainless steel is not acid-resistant. It is therefore also not suitable for fastening woods that contain tannin (e. g.: oak)
- Hardened stainless steel can be magnetised
- Stainless steel in accordance with DIN 10088
- The screw is suitable for use in timber / timber joints in outdoor installations and is used for gardens, façades and balconies

# Technical information

## Paneltwistec magazine, blue galvanised

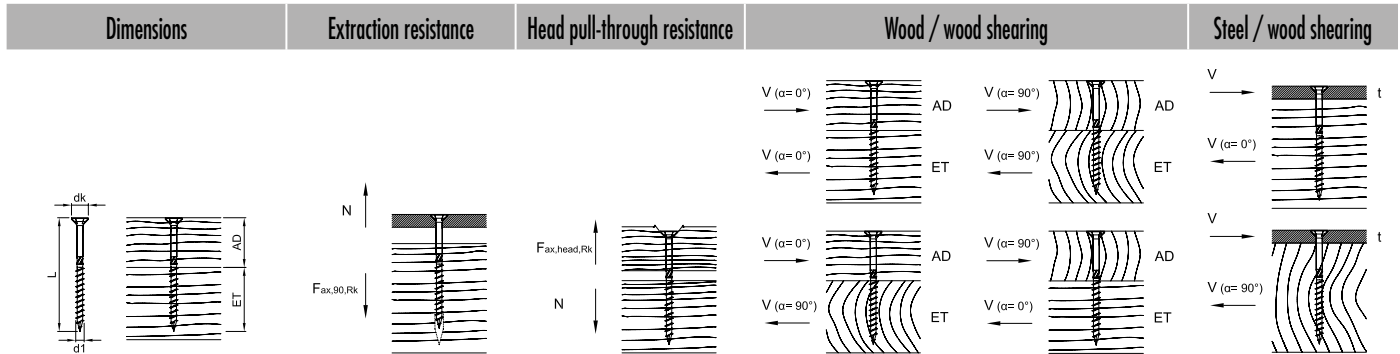

d1 x L [mm]	dk [mm]	AD [mm]	ET [mm]	F <sub>ax,90,Rk</sub> [kN]	F <sub>ax,head,Rk</sub> [kN]	F <sub>lo,Rk</sub> [kN]		F <sub>lo,Rk</sub> [kN]		t [mm]	F <sub>lo,Rk</sub> [kN]	
						α = 0°	α = 90°	α <sub>AD</sub> = 0°	α <sub>AD</sub> = 90°		α = 0°	α = 90°
4,0 x 40	8,0	16	24	1,24	0,77			0,84		2	1,15	
4,0 x 50	8,0	20	30	1,55	0,77			0,92		2	1,23	
4,0 x 60	8,0	24	36	1,86	0,77			1,01		2	1,31	
4,0 x 70	8,0	28	42	2,17	0,77			1,03		2	1,38	
4,5 x 50	9,0	20	30	1,69	0,97			1,08		2	1,44	
4,5 x 60	9,0	24	36	2,03	0,97			1,17		2	1,53	
5,0 x 50	10,0	20	30	1,82	1,20			1,24		2	1,67	
5,0 x 60	10,0	24	36	2,18	1,20			1,34		2	1,76	
5,0 x 70	10,0	28	42	2,54	1,20			1,44		2	1,85	
5,0 x 80	10,0	32	48	2,90	1,20			1,52		2	1,94	

Calculation according to ETA-11/0024. Wood density ρ<sub>k</sub> = 350 kg/m<sup>3</sup>. All mechanical values provided should be viewed as subject to the assumptions that have been made and represent example calculations.

All values are calculated minimum values and are subject to typographical and printing errors.

a) The characteristic values of the load-bearing capacity R<sub>k</sub> cannot be treated as equivalent to the max. possible load (the max. force). Characteristic values of the load-bearing capacity R<sub>k</sub> should be reduced to dimensioning values R<sub>d</sub> with regard to the usage class and class of the load duration: R<sub>d</sub> = R<sub>k</sub> · k<sub>mod</sub> / γ<sub>M</sub>. The dimensioning values of the load-bearing capacity R<sub>d</sub> should be contrasted with the dimensioning values of the loads (R<sub>d</sub> ≥ E<sub>d</sub>).

### Example:

Characteristic value for constant load (dead weight) G<sub>k</sub> = 2,00 kN and variable load (e. g. snow load) Q<sub>k</sub> = 3,00 kN. k<sub>mod</sub> = 0,9. γ<sub>M</sub> = 1,3.

→ Dimensioning value of the load E<sub>d</sub> = 2,00 · 1,35 + 3,00 · 1,5 = 7,20 kN.

The load-bearing capacity of the joint is therefore considered to have been demonstrated if R<sub>d</sub> ≥ E<sub>d</sub>. → min R<sub>k</sub> = R<sub>d</sub> · γ<sub>M</sub> / k<sub>mod</sub>

i.e. the characteristic minimum value is calculated based on: min R<sub>k</sub> = R<sub>d</sub> · γ<sub>M</sub> / k<sub>mod</sub> → R<sub>k</sub> = 7,20 kN · 1,3 / 0,9 = 10,40 kN → comparison with table values.

Please note: These are planning aids. Projects must only be calculated by authorised persons.





## Paneltwistec

Magazine, blue galvanised

**Now NEW  
shortened  
thread  
length**

Art. no.	Dimensions [mm]	Thread length [mm]	Drive	Pieces/belt	Coils/carton
905638	5,0 x 70	35	TX20 	125	5
905642	5,0 x 80	40	TX20 	125	5



### Advantages

- Shortened thread length enables pressing on of thicker attachments
- Resistant to mechanical stress
- Scraping groove ensures quick and easy screwing in

### Application

- For load-bearing timber structures between components made of solid structural timber, glued laminated timber, OSB boards and veneer laminated timber



# Technical information

## Panelwistec magazine, blue galvanised



Dimensions				Extraction resistance	Head pull-through resistance	Wood / wood shearing				Steel / wood shearing		
d1 x L [mm]	dk [mm]	AD [mm]	ET [mm]	F <sub>ax,90,Rk</sub> [kN]	F <sub>ax,head,Rk</sub> [kN]	F <sub>lo,Rk</sub> [kN]	F <sub>lo,Rk</sub> [kN]	F <sub>lo,Rk</sub> [kN]	F <sub>lo,Rk</sub> [kN]	t [mm]	F <sub>lo,Rk</sub> [kN]	F <sub>lo,Rk</sub> [kN]
								$\alpha_{AD} = 0^\circ$	$\alpha_{AD} = 90^\circ$			
						$\alpha = 0^\circ$	$\alpha = 90^\circ$	$\alpha_{ET} = 90^\circ$	$\alpha_{ET} = 0^\circ$		$\alpha = 0^\circ$	$\alpha = 90^\circ$
5,0 x 70	10,0	35	35	2,12	1,20			1,52		2	1,74	
5,0 x 80	10,0	40	40	2,42	1,20			1,52		2	1,82	

Calculation according to ETA-11/0024. Wood density  $\rho_k = 350 \text{ kg/m}^3$ . All mechanical values provided should be viewed as subject to the assumptions that have been made and represent example calculations.

All values are calculated minimum values and are subject to typographical and printing errors.

a) The characteristic values of the load-bearing capacity  $R_k$  cannot be treated as equivalent to the max. possible load (the max. force). Characteristic values of the load-bearing capacity  $R_k$  should be reduced to dimensioning values  $R_d$  with regard to the usage class and class of the load duration:  $R_d = R_k \cdot k_{mod} / \gamma_M$ . The dimensioning values of the load-bearing capacity  $R_d$  should be contrasted with the dimensioning values of the loads ( $R_d \geq E_d$ ).

### Example:

Characteristic value for constant load (dead weight)  $G_k = 2,00 \text{ kN}$  and variable load (e. g. snow load)  $Q_k = 3,00 \text{ kN}$ .  $k_{mod} = 0,9$ .  $\gamma_M = 1,3$ .

→ Dimensioning value of the load  $E_d = 2,00 \cdot 1,35 + 3,00 \cdot 1,5 = 7,20 \text{ kN}$ .

The load-bearing capacity of the joint is therefore considered to have been demonstrated if  $R_d \geq E_d$ . →  $\min R_k = R_d \cdot \gamma_M / k_{mod}$

i.e. the characteristic minimum value is calculated based on:  $\min R_k = R_d \cdot \gamma_M / k_{mod} \rightarrow R_k = 7,20 \text{ kN} \cdot 1,3 / 0,9 = 10,40 \text{ kN}$  → comparison with table values.

Please note: These are planning aids. Projects must only be calculated by authorised persons.

# Topduo Roofing screw

The wood-construction screw for all over-rafter insulation systems



## Topduo Roofing screw

Flanged button-head



- Can also be used for many other applications in timber-frame construction thanks to its high extraction resistance



### Advantages of the screw tip

- Reduced screwing torque
- Reduced splitting effect
- Screws have a better „bite“

## Topduo Roofing screw

Cylinder-head



- Can also be used for many other applications in timber-frame construction thanks to its high extraction resistance



### Advantages of the screw tip

- Reduced screwing torque
- Reduced splitting effect
- Screws have a better „bite“

Art. no.	Dimensions [mm]	Length [mm] <sup>a)</sup>	Drive	PU
945870	8,0 x 165	60/80	TX40 ●	50
945871	8,0 x 195	60/100	TX40 ●	50
945813	8,0 x 225	60/100	TX40 ●	50
945814	8,0 x 235	60/100	TX40 ●	50
945815	8,0 x 255	60/100	TX40 ●	50
945816	8,0 x 275	60/100	TX40 ●	50
945817	8,0 x 302	60/100	TX40 ●	50
945818	8,0 x 335	60/100	TX40 ●	50
945819	8,0 x 365	60/100	TX40 ●	50
945820	8,0 x 397	60/100	TX40 ●	50
945821	8,0 x 435	60/100	TX40 ●	50
945843	8,0 x 472	60/100	TX40 ●	50

a) Under-head thread/drive thread

Art. no.	Dimensions [mm]	Length [mm] <sup>a)</sup>	Drive	PU
945956	8,0 x 225	60/100	TX40 ●	50
945965	8,0 x 235	60/100	TX40 ●	50
945957	8,0 x 255	60/100	TX40 ●	50
945958	8,0 x 275	60/100	TX40 ●	50
945960	8,0 x 302	60/100	TX40 ●	50
945961	8,0 x 335	60/100	TX40 ●	50
945962	8,0 x 365	60/100	TX40 ●	50
945963	8,0 x 397	60/100	TX40 ●	50
945964	8,0 x 435	60/100	TX40 ●	50

a) Under-head thread/drive thread

## Fastening options:

**Solely 90° screw connection**  
(absorbion of wind suction)



**Combined 65° and 90° screw connection**  
(absorbion of shearing forces and wind suction)



**Topduo is suitable for pressure resistant (≥ 50 kPa) and non-pressure resistant insulations.**

The compressive strength  $\sigma_{10\%}$  can be found in the product data sheet issued by the insulating material manufacturer.



# Calculating quantities for Topduo roof construction screw

## Statically non-pressure-resistant insulating materials at $\sigma_{10\%} < 50 \text{ kPa}$

Design sample for specified assumptions, project-related design may yield significantly more favourable results

Number of Topduo screws per m<sup>2</sup>

Insulation thickness		40	60	80	100	120	140	140	160	180	200	220	240	260	280
Boarding thickness (on rafters)		24	24	24	24	24	–	24	24	24	24	24	24	24	24
Dimensions Topduo Flanged button-head acc. Cylinder-head <sup>b)</sup>		8 x 165 <sup>b)</sup>	8 x 195 <sup>b)</sup>	8 x 225	8 x 235	8 x 255	8 x 275	8 x 302	8 x 335	8 x 335	8 x 365	8 x 365	8 x 397	8 x 435	8 x 435
		[mm]	[mm]	[mm]	[mm]	[mm]	[mm]	[mm]	[mm]	[mm]	[mm]	[mm]	[mm]	[mm]	[mm]
Snow load zone 2 <sup>c)</sup> Wind zone 4 <sup>d)</sup> Altitude NN ≤ 285 m	0° ≤ DN ≤ 10°	2,20	2,20	2,38	2,38	2,38	2,38	2,38	2,29	2,29	2,48	3,01	3,57	4,08	4,76
	10° < DN ≤ 25°	2,38	2,38	2,60	2,60	2,60	2,60	2,60	2,60	2,60	3,17	3,81	4,40	e)	e)
	25° < DN ≤ 40°	2,72	2,72	3,01	3,01	3,01	3,01	3,01	3,01	3,01	3,57	4,40	5,19	e)	e)
	40° < DN ≤ 60°	2,86	3,01	3,17	3,17	3,36	3,36	3,36	3,36	3,36	3,57	4,40	5,19	e)	e)
Snow load zone 3 <sup>b)</sup> Wind zone 2 <sup>d)</sup> Altitude NN ≤ 600 m	0° ≤ DN ≤ 10°	1,79	1,79	1,97	2,04	2,04	2,04	2,04	2,12	2,60	3,81	4,40	5,19	e)	e)
	10° < DN ≤ 25°	2,29	2,29	2,48	2,60	2,60	2,60	2,60	2,72	3,36	4,76	e)	e)	e)	e)
	25° < DN ≤ 40°	2,38	2,48	2,72	2,72	2,72	2,86	2,86	2,86	3,57	5,19	e)	e)	e)	e)
	40° < DN ≤ 60°	2,60	2,60	2,86	2,86	2,86	2,86	2,86	3,01	3,57	5,19	e)	e)	e)	e)

a) Quantity always refers to the less favourable value from Topduo Flanged button-head and Cylinder-head

b) Topduo Flanged button-head only, c) Includes snow load zones 1, 2 and 2\*, d) Includes all wind zones apart from North Sea islands

e) Use of our project assessment service is recommended. The design examples listed here represent unfavourable, i.e. statically safe, instances.

f) Includes snow load zones 1, 2 and 3, g) Includes wind zones 1 and 2 (inland)

### Further assumptions:

Design with ECS design software in accordance with ETA-11/0024; screw-in angle 65°; gabled roof; ridge height above ground max. 18 m; gross density insulation 1,50 kN/m<sup>3</sup>; rafters C24 8/≥12 cm; counter batten C24 4/6 cm; rafter centre distance 0,70 m; roofing dead weight 0,55 kN/m<sup>2</sup>; snow guard available; quantity calculation regarding wind pressure after the most unfavourable roof area.

All listed values should be viewed as subject to the assumptions that have been made. They therefore represent example calculations and are subject to typographical and printing errors.

Please note: These are planning aids. Projects must only be calculated by authorised persons.

# Calculating quantities for Topduo roofing screw

## Statically pressure-resistant insulating materials at $\sigma_{10\%} \geq 50 \text{ kPa}$

Design sample for specified assumptions, project-related design may yield significantly more favourable results

Number of Topduo screws per m<sup>2</sup>

Insulation thickness		40	60	80	100	120	140	160	180	200	220	240	260	280	300
Boarding thickness (on rafters)		24	24	24	24	24	24	24	24	24	24	24	24	24	24
Dimensions Topduo Flanged button-head acc. Cylinder-head <sup>b)</sup>		8 x 195 <sup>b)</sup>	8 x 225	8 x 235	8 x 255	8 x 275	8 x 302	8 x 335	8 x 335	8 x 365	8 x 365	8 x 397	8 x 435	8 x 435	8 x 472 <sup>b)</sup>
		[mm]	[mm]	[mm]	[mm]	[mm]	[mm]	[mm]	[mm]	[mm]	[mm]	[mm]	[mm]	[mm]	[mm]
Snow load zone 2 <sup>c)</sup> Wind zone 4 <sup>d)</sup> Altitude NN ≤ 285 m	0° ≤ DN ≤ 10°	1,96	2,06	2,06	2,06	2,06	2,06	2,06	2,06	2,06	2,06	2,12	1,80	2,40	2,32
	10° < DN ≤ 25°	2,11	2,05	1,97	1,94	1,97	1,90	1,85	2,14	2,01	2,74	2,57	2,38	3,23	2,93
	25° < DN ≤ 40°	2,48	2,41	2,28	2,35	2,41	2,35	2,18	2,67	2,49	3,48	3,22	2,96	4,42	3,79
	40° < DN ≤ 60°	2,31	2,30	2,56	2,65	2,74	2,65	2,42	2,96	2,74	4,00	3,70	3,48	4,87	4,47
Snow load zone 3 <sup>b)</sup> Wind zone 2 <sup>d)</sup> Altitude NN ≤ 400 m	0° ≤ DN ≤ 10°	2,65	2,54	2,39	2,34	2,26	2,23	2,34	2,34	2,16	2,46	2,32	2,19	2,86	2,65
	10° < DN ≤ 25°	4,04	3,81	3,55	3,33	3,33	3,15	3,15	2,99	2,99	3,66	3,37	3,06	4,37	3,74
	25° < DN ≤ 40°	4,46	4,16	3,84	3,58	3,58	3,58	3,37	3,37	3,37	4,67	4,20	3,92	e)	e)
	40° < DN ≤ 60°	3,55	3,26	3,26	3,26	3,44	3,26	2,96	3,66	3,44	e)	4,67	4,27	e)	e)

a) Quantity always refers to the less favourable value from Topduo Flanged button-head and Cylinder-head

b) Topduo Flanged button-head only, c) Includes snow load zones 1, 2 and 2\* each with snow guard, d) Includes all wind zones apart from North Sea islands

e) Use of our project assessment service is recommended. The design examples listed here represent unfavourable, i.e. statically safe, instances.

f) Includes snow load zones 1, 2 and 3, g) Includes wind zones 1 and 2 (inland)

### Further assumptions:

Design with ECS design software in accordance with ETA-11/0024; screw-in angle roof thrust screw 65°/wind pressure screw 90°; gabled roof; ridge height above ground max. 18 m; gross density insulation 1,50 kN/m<sup>3</sup>; rafters C24 8/≥12 cm; counter batten C24 4/6 cm; rafter centre distance 0,70 m; roofing dead weight 0,55 kN/m<sup>2</sup>; snow guard available; quantity calculation with respect to wind pressure after the most unfavourable roof area.

All listed values should be viewed as subject to the assumptions that have been made. They therefore represent example calculations and are subject to typographical and printing errors.

Please note: These are planning aids. Projects must only be calculated by authorised persons.

by phone 02331 6245-444 · by fax 02331 6245-200 · by e-mail technik@eurotec.team

Please contact our technical department or use the free calculation services in the service section of our website.

## Contact

Trader: \_\_\_\_\_ Contractor: \_\_\_\_\_  
 Contact person: \_\_\_\_\_ Contact person: \_\_\_\_\_  
 e-mail: \_\_\_\_\_ Phone: \_\_\_\_\_  
 Project: \_\_\_\_\_ e-mail: \_\_\_\_\_

## Project details

Shed roof       Gable roof       Hip roof

Building length eave side: \_\_\_\_\_ m



Gable width: \_\_\_\_\_ m

Width counter batten: \_\_\_\_\_ mm  
(min. 60 mm)

Rafter length: \_\_\_\_\_ m  
(this information is optional)

Height counter batten: \_\_\_\_\_ mm  
(min. 40 mm)

Ridge height: \_\_\_\_\_ m  
(above ground)

Length counter batten: \_\_\_\_\_ m  
(actual counter batten length to be installed)

Roof overhang: eave \_\_\_\_\_ /verge \_\_\_\_\_ m  
(quantity is determined for total roof area)

Load from roofing and battens:

Roof pitch: main roof \_\_\_\_\_ /hip \_\_\_\_\_ °

Standing seam metal roofing      0,35 kN/m<sup>2</sup>

Concrete tile, clay tile      0,55 kN/m<sup>2</sup>

Insulation: \_\_\_\_\_

Flat tile roofing      0,75 kN/m<sup>2</sup>

Insulation thickness: \_\_\_\_\_ mm

or \_\_\_\_\_ kN/m<sup>2</sup>

Rafter width: \_\_\_\_\_ mm

Postcode of project: \_\_\_\_\_  
(to determine the wind and snow load zone)

Rafter height: \_\_\_\_\_ mm

charact. snow load on ground sk: \_\_\_\_\_ /m<sup>2</sup>  
(only for municipalities with special provision)

Rafter center distance: \_\_\_\_\_ mm

Site elevation above sea level: \_\_\_\_\_ m  
(important for municipalities with complex relief)

Sheathing thickness: \_\_\_\_\_ mm

Snow guard provided?       Yes       No

## Screw selection

Paneltwistec countersunk head \*     Paneltwistec washer head \*     Topduo flange button head screw \*\*     Topduo cylinder-head \*\*

\* only for compression-proof insulations with compression strength  $\geq 50$  kPa    \*\* also for non-compression-proof insulations



# Paneltwistec, Paneltwistec AG

Hardened stainless steel

## Paneltwistec

Countersunk-head screw, hardened stainless steel

Stainless Steel



- Limited resistance to acid
- Not suitable for use with woods containing tanning agents such as cumarú, oak, merbau, robinia, etc.
- Magnetised
- Stainless steel in accordance with DIN 10088
- The screw is suitable for use in timber/timber joints in outdoor installations and is used in garden, façade and balcony construction



Art. no.	Dimensions [mm]	Drive	PU
904474	4,0 x 40	TX20 ●	500
904475	4,0 x 45	TX20 ●	500
904476	4,0 x 50	TX20 ●	500
904477	4,0 x 60	TX20 ●	500
904478	4,5 x 45	TX20 ●	200
904479	4,5 x 50	TX20 ●	200
904480	4,5 x 60	TX20 ●	200
904481	4,5 x 70	TX20 ●	200
100981	4,5 x 80	TX20 ●	200
904482	5,0 x 50	TX25 ●	200
904483	5,0 x 60	TX25 ●	200
904484	5,0 x 70	TX25 ●	200
904485	5,0 x 80	TX25 ●	200
904487	5,0 x 90	TX25 ●	100
904011	5,0 x 100	TX25 ●	100
904012	6,0 x 60	TX30 ●	100
904013	6,0 x 70	TX30 ●	100
904014	6,0 x 80	TX30 ●	100
904015	6,0 x 90	TX30 ●	100
904016	6,0 x 100	TX30 ●	100
904017	6,0 x 120	TX30 ●	100
904018	6,0 x 140	TX30 ●	100
904019	6,0 x 160	TX30 ●	100

## Paneltwistec

Flanged button-head screw, hardened stainless steel

Stainless Steel



- Also suitable for fastening over-rafter insulation
- The larger head diameter allows for considerably higher torque and head pull-through capacity
- This makes for better use of the screw's tensile load-bearing strength



Art. no.	Dimensions [mm]	Drive	PU
945278	8,0 x 80	TX40 ●	50
945270	8,0 x 100	TX40 ●	50
945271	8,0 x 120	TX40 ●	50
945272	8,0 x 140	TX40 ●	50
945364	8,0 x 160	TX40 ●	50
945365	8,0 x 180	TX40 ●	50
945366	8,0 x 200	TX40 ●	50
945367	8,0 x 220	TX40 ●	50
945368	8,0 x 240	TX40 ●	50
945369	8,0 x 260	TX40 ●	50
945370	8,0 x 280	TX40 ●	50
945371	8,0 x 300	TX40 ●	50
945372	8,0 x 320	TX40 ●	50
945373	8,0 x 340	TX40 ●	50
945374	8,0 x 360	TX40 ●	50
945375	8,0 x 380	TX40 ●	50
945376	8,0 x 400	TX40 ●	50

## Paneltwistec AG

Flanged button-head screw, hardened stainless steel

Stainless Steel



Art. no.	Dimensions [mm]	Drive	PU
975772	6,0 x 60	TX30 ●	100
975773	6,0 x 80	TX30 ●	100
975774	6,0 x 100	TX30 ●	100
975775	6,0 x 120	TX30 ●	100
975776	6,0 x 140	TX30 ●	100
975777	6,0 x 160	TX30 ●	100

# Paneltwistec A4 / A2, OSB Fix, Washer

Stainless steel A4/A2

## Paneltwistec A4

Countersunk-head screw, Stainless steel A4

Stainless Steel



Art. no.	Dimensions [mm]	Drive	PU
901476	4,0 x 25	TX20 ●	500
111442	4,0 x 35	TX20 ●	500
903202	4,0 x 40	TX20 ●	500
111443	4,0 x 45	TX20 ●	500
901109	4,0 x 55	TX20 ●	500
111444	4,0 x 60	TX20 ●	500
111445	4,0 x 70	TX20 ●	200
111446	4,0 x 80	TX20 ●	200
111447	4,5 x 45	TX25 ●	200
111448	4,5 x 60	TX25 ●	200
111449	4,5 x 70	TX25 ●	200
111450	4,5 x 80	TX25 ●	200
903990	5,0 x 40	TX25 ●	200
111451	5,0 x 50	TX25 ●	200
111452	5,0 x 60	TX25 ●	200
111453	5,0 x 70	TX25 ●	200
111454	5,0 x 80	TX25 ●	200
903580	5,0 x 100	TX25 ●	200
111459	6,0 x 60	TX30 ●	100
944885	6,0 x 70	TX30 ●	100
111460	6,0 x 80	TX30 ●	100
111458	6,0 x 100	TX30 ●	100
901478	6,0 x 120	TX30 ●	100
903280	8,0 x 80	TX40 ●	50
903281	8,0 x 100	TX40 ●	50
903282	8,0 x 120	TX40 ●	50
903283	8,0 x 140	TX40 ●	50
903284	8,0 x 160	TX40 ●	50
903285	8,0 x 180	TX40 ●	50
903286	8,0 x 200	TX40 ●	50
903287	8,0 x 220	TX40 ●	50
903288	8,0 x 240	TX40 ●	50
903289	8,0 x 260	TX40 ●	50
903290	8,0 x 280	TX40 ●	50
903291	8,0 x 300	TX40 ●	50
903292	8,0 x 320	TX40 ●	50
903293	8,0 x 340	TX40 ●	50
903294	8,0 x 360	TX40 ●	50
903295	8,0 x 380	TX40 ●	50
903296	8,0 x 400	TX40 ●	50



## Paneltwistec A4

Ornamental-head, Stainless steel A4

Can be combined with EPDM facade tape

Stainless Steel



- Limited resistance to acid
- Suitable for use with woods containing tanning agents such as cumarú, oak, merbau, robinia, etc.
- Suitable for saline atmospheres
- Not suitable for atmospheres containing chlorine
- The screw is suitable for use in timber/timber joints in outdoor installations and is used in garden, façade and balcony construction



Art. no.	Dimensions [mm]	Drive	PU
901479	3,2 x 25	TX10 ◯	1000
903038	3,2 x 30	TX10 ◯	1000
901480	3,2 x 35	TX10 ◯	1000
901481	3,2 x 40	TX10 ◯	1000
903104	3,2 x 50	TX10 ◯	1000

## Paneltwistec A4

Flanged button-head screw, Stainless steel A4

Stainless Steel



- Limited resistance to acid
- Suitable for use with woods containing tanning agents such as cumarú, oak, merbau, robinia, etc.
- Suitable for saline atmospheres
- Not suitable for atmospheres containing chlorine
- The screw is suitable for use in timber/timber joints in outdoor installations and is used in garden, façade and balcony construction



Art. no.	Dimensions [mm]	Drive	PU
903260	8,0 x 80	TX40 ●	50
903261	8,0 x 100	TX40 ●	50
903262	8,0 x 120	TX40 ●	50
903263	8,0 x 140	TX40 ●	50
903264	8,0 x 160	TX40 ●	50
903265	8,0 x 180	TX40 ●	50
903266	8,0 x 200	TX40 ●	50
903267	8,0 x 220	TX40 ●	50
903268	8,0 x 240	TX40 ●	50
903269	8,0 x 260	TX40 ●	50
903270	8,0 x 280	TX40 ●	50
903271	8,0 x 300	TX40 ●	50
903272	8,0 x 320	TX40 ●	50
903273	8,0 x 340	TX40 ●	50
903274	8,0 x 360	TX40 ●	50
903275	8,0 x 380	TX40 ●	50
903276	8,0 x 400	TX40 ●	50

## Paneltwistec A2

Countersunk-head screw, Stainless steel A2

**Stainless Steel**



- Limited resistance to acid
- Not suitable for atmospheres containing chlorine



## Paneltwistec A2

Flanged button-head screw, Stainless steel A2

**Stainless Steel**



- Limited resistance to acid
- Not suitable for atmospheres containing chlorine



## OSB Fix

Countersunk head, yellow galvanised steel

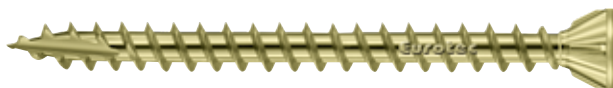

### Properties

- Fully threaded screw holds board in position
- Prevention of creaking noises
- Suitable for all wood-based materials
- Yellow galvanised Cr3 surface



## Washer

Yellow/blue galvanised steel



Art. no.	Dimensions [mm]	Drive	PU
903230	8,0 x 80	TX40 ●	50
903231	8,0 x 100	TX40 ●	50
903232	8,0 x 120	TX40 ●	50
903233	8,0 x 140	TX40 ●	50
903234	8,0 x 160	TX40 ●	50
903235	8,0 x 180	TX40 ●	50
903236	8,0 x 200	TX40 ●	50
903237	8,0 x 220	TX40 ●	50
903238	8,0 x 240	TX40 ●	50
903239	8,0 x 260	TX40 ●	50
903240	8,0 x 280	TX40 ●	50
903241	8,0 x 300	TX40 ●	50
903242	8,0 x 320	TX40 ●	50
903243	8,0 x 340	TX40 ●	50
903244	8,0 x 360	TX40 ●	50
903245	8,0 x 380	TX40 ●	50
903246	8,0 x 400	TX40 ●	50

Art. no.	Dimensions [mm]	Drive	PU
903211	8,0 x 80	TX40 ●	50
903212	8,0 x 100	TX40 ●	50
903213	8,0 x 120	TX40 ●	50
903214	8,0 x 140	TX40 ●	50
903215	8,0 x 160	TX40 ●	50
903216	8,0 x 180	TX40 ●	50
903217	8,0 x 200	TX40 ●	50
903218	8,0 x 220	TX40 ●	50
903219	8,0 x 240	TX40 ●	50
903220	8,0 x 260	TX40 ●	50
903221	8,0 x 280	TX40 ●	50
903222	8,0 x 300	TX40 ●	50
903223	8,0 x 320	TX40 ●	50
903224	8,0 x 340	TX40 ●	50
903225	8,0 x 360	TX40 ●	50
903226	8,0 x 380	TX40 ●	50
903227	8,0 x 400	TX40 ●	50

Art. no.	Dimensions [mm]	Drive	PU
900690	4,3 x 40	TX20 ●	250
900691	4,3 x 45	TX20 ●	250
900692	4,3 x 50	TX20 ●	250
900693	4,3 x 60	TX20 ●	250
900694	4,3 x 80	TX20 ●	250

Art. no.	Screw Ø	D1	D2	PU
<b>blue</b>				
903640	5,0	5,35	16	100
900098	6,0	8,0	20	50
900099	8,0	9,0	25	50
8901032	10,0	12,0	32	50
<b>yellow</b>				
900095	5,0	5,35	16	100
900096	6,0	8,0	20	50
900097	8,0	9,0	25	50
901032	10,0	12,0	32	50
900087	12,0	14,0	37	50

D1 = Inside diameter, D2 = Outside diameter



# Hobotec screw

Galvanised steel and hardened stainless steel

## Hobotec screw

Galvanised steel

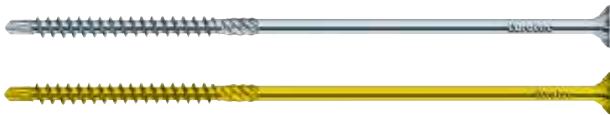

Hobotec screws allow easy, fast and tidy fastening of timber-timber joints. These screws are especially suitable for applications with a higher risk of cracking and splitting. The new type of thread and innovative drill point ensure a clean fit and high extraction-resistance values.



### Advantages

- No pilot-drilling necessary
- No cracking or splitting in narrow edge areas
- No hammering of the screws thanks to TX drive

### Especially suitable for

Applications in the fields of model-making, staircase construction and façade construction and for carpentry, joinery and roofing work.

Art. no. (yellow)	Art. no. (blue)	Dimensions [mm]	Drive	PU
110045*	111494	4,0 x 30	TX15 ●	1000
	111495	4,0 x 35	TX15 ●	1000
110047 *	111496	4,0 x 40	TX15 ●	1000
	111497	4,0 x 45	TX15 ●	500
	111498	4,0 x 50	TX15 ●	500
	111499	4,0 x 60	TX15 ●	200
110050 *	111501	4,5 x 35	TX20 ●	500
110077*	111502	4,5 x 40	TX20 ●	500
110052*	111503	4,5 x 45	TX20 ●	500
	111504	4,5 x 50	TX20 ●	500
	111505	4,5 x 60	TX20 ●	200
110055*	111506	4,5 x 70	TX20 ●	200
	111507	5,0 x 40	TX25 ●	200
	111508	5,0 x 50	TX25 ●	200
	111509	5,0 x 60	TX25 ●	200
	111510	5,0 x 70	TX25 ●	200
	111511	5,0 x 80	TX25 ●	200
	111512	5,0 x 90	TX25 ●	200
900462*	903623	5,0 x 100	TX25 ●	200
	903117	6,0 x 80	TX25 ●	200
	903118	6,0 x 90	TX25 ●	100
	903119	6,0 x 100	TX25 ●	100
	903120	6,0 x 120	TX25 ●	100
	903121	6,0 x 140	TX25 ●	100
	903122	6,0 x 160	TX25 ●	100

\* Discontinued item

## Hobotec screw

Hardened stainless steel

Can be combined with EPDM facade tape

Stainless Steel



- Limited resistance to acid
- Suitable for use with woods containing tanning agents such as cumarú, oak, merbau, robinia, etc.
- Magnetised
- Stainless steel in accordance with DIN 10088

Art. no.	Dimensions [mm]	Drive	PU
903323	4,0 x 30	TX15 ●	500
110299	4,0 x 40	TX15 ●	500
110300	4,0 x 45	TX15 ●	500
110301	4,0 x 50	TX15 ●	500
110302	4,0 x 60	TX15 ●	500
110319	4,5 x 40	TX20 ●	200
944839	4,5 x 45	TX20 ●	200
110303	4,5 x 50	TX20 ●	200
110304	4,5 x 60	TX20 ●	200
110305	4,5 x 70	TX20 ●	200
110306	4,5 x 80	TX20 ●	200
110307	5,0 x 50	TX25 ●	200
110308	5,0 x 60	TX25 ●	200
110309	5,0 x 70	TX25 ●	200
110310	5,0 x 80	TX25 ●	200
110311	5,0 x 90	TX25 ●	200
110312	5,0 x 100	TX25 ●	200
110313	6,0 x 80	TX25 ●	100
110314	6,0 x 90	TX25 ●	100
110315	6,0 x 100	TX25 ●	100
110316	6,0 x 120	TX25 ●	100
110317	6,0 x 140	TX25 ●	100
110318	6,0 x 160	TX25 ●	100



On request, screw heads can be painted in RAL Colours.

# EcoTec



## EcoTec

Chipboard screw, blue galvanised

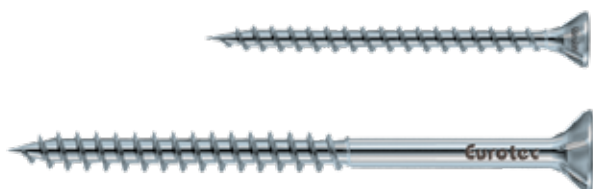

- Suitable for indoor use; with countersunk-head screw, self-milling ribs, TX drive, both fully threaded and partially threaded (FT, PT)
- Only three TX sizes are required for the entire series



Art. no.	Dimensions [mm]	Drive	Thread	PU
903714	3,0 x 13	TX10 ◊	FT	1000
903715	3,0 x 15	TX10 ◊	FT	1000
903716	3,0 x 20	TX10 ◊	FT	1000
903717	3,0 x 25	TX10 ◊	FT	1000
903718	3,0 x 30	TX10 ◊	FT	1000
903719	3,0 x 35	TX10 ◊	FT	1000
903720	3,0 x 40	TX10 ◊	PT	1000
903721	3,0 x 45	TX10 ◊	PT	1000
903722	3,5 x 12	TX20 ●	FT	1000
903723	3,5 x 15	TX20 ●	FT	1000
903724	3,5 x 20	TX20 ●	FT	1000
903725	3,5 x 25	TX20 ●	FT	1000
903726	3,5 x 30	TX20 ●	FT	1000
903727	3,5 x 35	TX20 ●	PT	1000
903728	3,5 x 40	TX20 ●	PT	1000
903729	3,5 x 45	TX20 ●	PT	500
903730	3,5 x 50	TX20 ●	PT	500
903731	4,0 x 15	TX20 ●	FT	1000
903732	4,0 x 20	TX20 ●	FT	1000
903733	4,0 x 25	TX20 ●	FT	1000
903734	4,0 x 30	TX20 ●	FT	1000
903735	4,0 x 35	TX20 ●	FT	1000
903736	4,0 x 40	TX20 ●	PT	1000
903737	4,0 x 45	TX20 ●	PT	500
903738	4,0 x 50	TX20 ●	PT	500
903739	4,0 x 60	TX20 ●	PT	200
903740	4,0 x 70	TX20 ●	PT	200
903783	4,0 x 80	TX20 ●	PT	200
903741	4,5 x 20	TX20 ●	FT	500
903742	4,5 x 25	TX20 ●	FT	500
903743	4,5 x 30	TX20 ●	FT	500
903744	4,5 x 35	TX20 ●	FT	500
903745	4,5 x 40	TX20 ●	PT	500
903746	4,5 x 45	TX20 ●	PT	500
903747	4,5 x 50	TX20 ●	PT	500
903748	4,5 x 60	TX20 ●	PT	200
903749	4,5 x 70	TX20 ●	PT	200
903750	4,5 x 80	TX20 ●	PT	200
903751	5,0 x 20	TX20 ●	FT	500
903752	5,0 x 25	TX20 ●	FT	500
903753	5,0 x 30	TX20 ●	FT	500
903754	5,0 x 35	TX20 ●	FT	500
903755	5,0 x 40	TX20 ●	PT	200
903756	5,0 x 45	TX20 ●	PT	200
903757	5,0 x 50	TX20 ●	PT	200
903758	5,0 x 60	TX20 ●	PT	200
903759	5,0 x 70	TX20 ●	PT	200
903760	5,0 x 80	TX20 ●	PT	200
903761	5,0 x 90	TX20 ●	PT	200
903762	5,0 x 100	TX20 ●	PT	200
903763	5,0 x 120	TX20 ●	PT	200
903764	6,0 x 40	TX30 ●	FT	200
903765	6,0 x 50	TX30 ●	FT	200
903766	6,0 x 60	TX30 ●	PT	200
903767	6,0 x 70	TX30 ●	PT	200
903768	6,0 x 80	TX30 ●	PT	200
903769	6,0 x 90	TX30 ●	PT	100

More sizes on the next page



Art. no.	Dimensions [mm]	Drive	Thread	PU
903770	6,0 x 100	TX30 ●	PT	100
903771	6,0 x 120	TX30 ●	PT	100
903772	6,0 x 140	TX30 ●	PT	100
904540	6,0 x 160	TX30 ●	PT	100
904541	6,0 x 180	TX30 ●	PT	100
904542	6,0 x 200	TX30 ●	PT	100
904617	6,0 x 220	TX30 ●	PT	100
904618	6,0 x 240	TX30 ●	PT	100
904619	6,0 x 260	TX30 ●	PT	100
904620	6,0 x 280	TX30 ●	PT	100
904621	6,0 x 300	TX30 ●	PT	100

PLEASE NOTE: Screws with  $\varnothing = 3,0$  mm are not regulated by an ETA

## EcoTec A2

Chipboard screw, Stainless steel A2



- With countersunk-head screw, self-milling ribs, TX drive
- With partial thread (PT)/with full thread (FT)
- Only two TX sizes are required for the entire series
- Limited resistance to acid
- Not suitable for atmospheres containing chlorine



Art. no.	Dimensions [mm]	Drive	Thread	PU
903824	4,0 x 30	TX20 ●	VG	500
903791	4,0 x 35	TX20 ●	VG	1000
903792	4,0 x 40	TX20 ●	TG	1000
903793	4,0 x 45	TX20 ●	TG	500
903794	4,0 x 50	TX20 ●	TG	500
903795	4,0 x 60	TX20 ●	TG	200
903796	4,0 x 70	TX20 ●	TG	200
903797	4,0 x 80	TX20 ●	TG	200
903836	4,5 x 20	TX20 ●	VG	500
903837	4,5 x 25	TX20 ●	VG	500
903838	4,5 x 30	TX20 ●	VG	500
903839	4,5 x 35	TX20 ●	VG	500
903840	4,5 x 40	TX20 ●	TG	500
903798	4,5 x 45	TX20 ●	TG	500
903799	4,5 x 50	TX20 ●	TG	500
903800	4,5 x 60	TX20 ●	TG	200
903801	4,5 x 70	TX20 ●	TG	200
903802	4,5 x 80	TX20 ●	TG	200
903841	5,0 x 40	TX25 ●	TG	500
903803	5,0 x 50	TX25 ●	TG	200
903804	5,0 x 60	TX25 ●	TG	200
903805	5,0 x 70	TX25 ●	TG	200
903806	5,0 x 80	TX25 ●	TG	200
903807	5,0 x 90	TX25 ●	TG	200
903808	5,0 x 100	TX25 ●	TG	200
903809	5,0 x 120	TX25 ●	TG	200
903810	6,0 x 50	TX25 ●	TG	200
903811	6,0 x 60	TX25 ●	TG	200
903812	6,0 x 70	TX25 ●	TG	200
903813	6,0 x 80	TX25 ●	TG	200
903814	6,0 x 90	TX25 ●	TG	100
903815	6,0 x 100	TX25 ●	TG	100
903816	6,0 x 120	TX25 ●	TG	100
903817	6,0 x 140	TX25 ●	TG	100
903818	6,0 x 160	TX25 ●	TG	100
903825	6,0 x 180	TX25 ●	TG	100
903826	6,0 x 200	TX25 ●	TG	100

# LBS construction screw

Hardwood screw for fixing elements of laminated beech veneer wood



## LBS construction screw

Countersunk-head screw, blue galvanised



### Advantages

- Special thread geometry and especially high breaking torque enable the screw to be set without pre-drilling
- Optimised sliding coating for use in hardwood

### Use in laminated veneer beechwood without pre-drilling

The Eurotec LBS construction screw is a wood screw that can be used to connect components made of laminated veneer beechwood to one other or that can be used to affix attachments made of other woods, wood-based materials and steel can to laminated veneer beechwood. The LBS construction screw is intended for use in load-bearing structures in service classes 1 and 2. The European Technical Assessment has been applied for.

Art. no.	Dimensions [mm]	Drive	PU
904881	8,0 x 80	TX40 ●	50
904882	8,0 x 100	TX40 ●	50
904883	8,0 x 120	TX40 ●	50
904884	8,0 x 140	TX40 ●	50
904885	8,0 x 160	TX40 ●	50
904886	8,0 x 180	TX40 ●	50
904887	8,0 x 200	TX40 ●	50
904888	8,0 x 220	TX40 ●	50
904889	8,0 x 240	TX40 ●	50

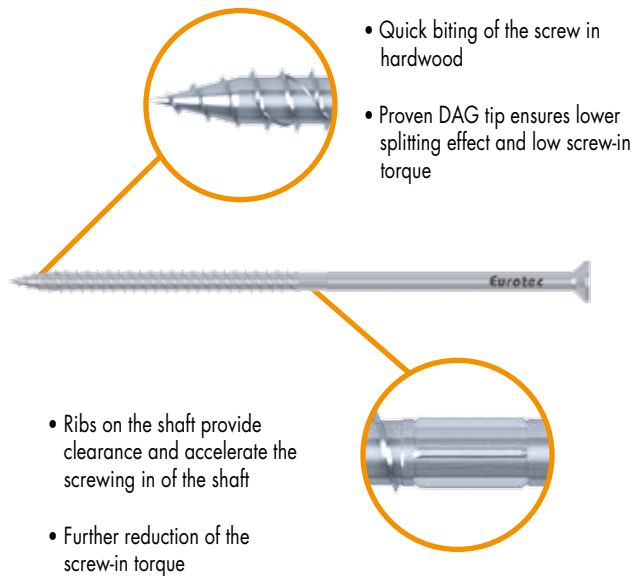



# Technical information

## LBS construction screw, Countersunk-head screw, blue galvanised

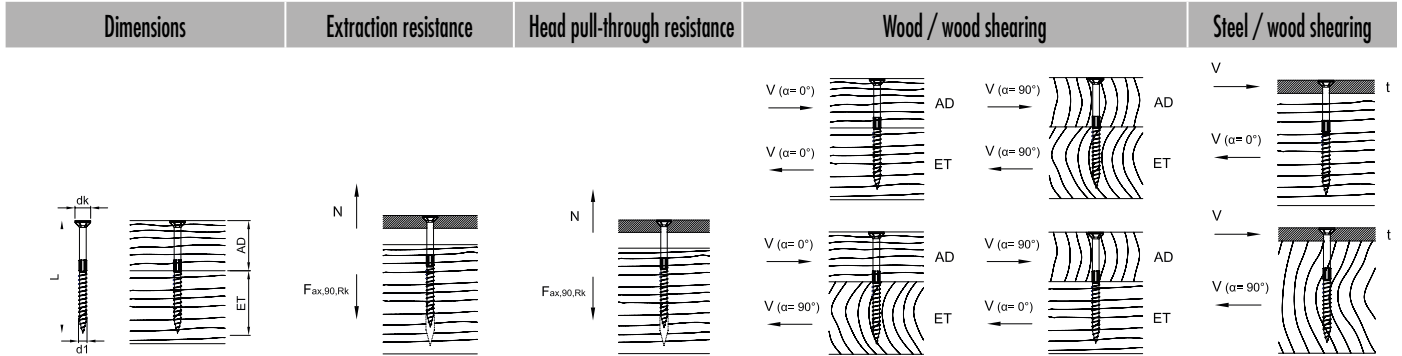

d1 x L [mm]	dk [mm]	AD [mm]	ET [mm]	F <sub>ax,90,Rk</sub> [kN]	F <sub>ax,head,Rk</sub> [kN]	F <sub>la,Rk</sub> [kN]				t [mm]	F <sub>la,Rk</sub> [kN]	
						α=0°		α=90°			α=0°	α=90°
								α <sub>AD</sub> =0°	α <sub>AD</sub> =90°			
							α=0°	α=90°	α <sub>ET</sub> =90°	α <sub>ET</sub> =0°		α=0° α=90°
8,0 x 80	15,0	30	50	15,20	10,80	8,93	7,26	8,93	7,26	3	10,56	9,36
8,0 x 100	15,0	30	70	21,28	10,80	8,93	7,26	8,93	7,26	3	12,08	10,88
8,0 x 120	15,0	40	80	24,32	10,80	9,46	8,19	9,46	8,19	3	12,84	11,11
8,0 x 140	15,0	60	80	24,32	10,80	9,46	8,26	9,46	8,26	3	12,84	11,11
8,0 x 160	15,0	80	80	24,32	10,80	9,46	8,26	9,46	8,26	3	12,84	11,11
8,0 x 180	15,0	100	80	24,32	10,80	9,46	8,26	9,46	8,26	3	12,84	11,11
8,0 x 200	15,0	120	80	24,32	10,80	9,46	8,26	9,46	8,26	3	12,84	11,11
8,0 x 220	15,0	140	80	24,32	10,80	9,46	8,26	9,46	8,26	3	12,84	11,11
8,0 x 240	15,0	160	80	24,32	10,80	9,46	8,26	9,46	8,26	3	12,84	11,11

Design according to test values to obtain a European Technical Assessment (ETA). Hardwood gross density ρ<sub>k</sub> = 530 kg/m<sup>3</sup>.  
 All mechanical values provided should be viewed as subject to the assumptions that have been made and represent example calculations.  
 All values are calculated minimum values and are subject to typographical and printing errors.

a) The characteristic values of the load-bearing capacity R<sub>k</sub> cannot be treated as equivalent to the max. possible load (the max. force). Characteristic values of the load-bearing capacity R<sub>k</sub> should be reduced to dimensioning values R<sub>d</sub> with regard to the usage class and class of the load duration: R<sub>d</sub> = R<sub>k</sub> · k<sub>mod</sub> / γ<sub>M</sub>. The dimensioning values of the load-bearing capacity R<sub>d</sub> should be contrasted with the dimensioning values of the loads (R<sub>d</sub> ≥ E<sub>d</sub>).

**Example:**

Characteristic value for constant load (dead weight) G<sub>k</sub> = 2,00 kN and variable load (e. g. snow load) Q<sub>k</sub> = 3,00 kN. k<sub>mod</sub> = 0,9. γ<sub>M</sub> = 1,3.  
 → Dimensioning value of the load E<sub>d</sub> = 2,00 · 1,35 + 3,00 · 1,5 = 7,20 kN.

The load-bearing capacity of the joint is therefore considered to have been demonstrated if R<sub>d</sub> ≥ E<sub>d</sub>. → min R<sub>k</sub> = R<sub>d</sub> · γ<sub>M</sub> / k<sub>mod</sub>  
 i.e. the characteristic minimum value is calculated based on: min R<sub>k</sub> = R<sub>d</sub> · γ<sub>M</sub> / k<sub>mod</sub> → R<sub>k</sub> = 7,20 kN · 1,3 / 0,9 = 10,40 kN → comparison with table values.

Please note: These are planning aids. Projects must only be calculated by authorised persons.

**The values specified here are experimental values.**

# ECO PT, Angle-bracket screw



## ECO PT

Countersunk-head screw, blue galvanised



- Wood construction screw with countersunk head, self-milling ribs, TX drive
- Also suitable for fastening over-rafter insulation



Art. no.	Dimensions [mm]	Drive	PU
954682	8,0 x 80	TX40 ●	50
954683	8,0 x 100	TX40 ●	50
954684	8,0 x 120	TX40 ●	50
954685	8,0 x 140	TX40 ●	50
954686	8,0 x 160	TX40 ●	50
954687	8,0 x 180	TX40 ●	50
954688	8,0 x 200	TX40 ●	50
954689	8,0 x 220	TX40 ●	50
954690	8,0 x 240	TX40 ●	50
954691	8,0 x 260	TX40 ●	50
954692	8,0 x 280	TX40 ●	50
954693	8,0 x 300	TX40 ●	50
954694	8,0 x 320	TX40 ●	50
954695	8,0 x 340	TX40 ●	50
954696	8,0 x 360	TX40 ●	50
954697	8,0 x 380	TX40 ●	50
954698	8,0 x 400	TX40 ●	50

## ECO PT

Flanged button-head screw, blue galvanised



- Wood construction screw with flanged button head, self-milling ribs, TX drive
- Also suitable for fastening over-rafter insulation



Art. no.	Dimensions [mm]	Drive	PU
954699	8,0 x 80	TX40 ●	50
954700	8,0 x 100	TX40 ●	50
954701	8,0 x 120	TX40 ●	50
954702	8,0 x 140	TX40 ●	50
954703	8,0 x 160	TX40 ●	50
954704	8,0 x 180	TX40 ●	50
954705	8,0 x 200	TX40 ●	50
954706	8,0 x 220	TX40 ●	50
954707	8,0 x 240	TX40 ●	50
954708	8,0 x 260	TX40 ●	50
954709	8,0 x 280	TX40 ●	50
954710	8,0 x 300	TX40 ●	50
954711	8,0 x 320	TX40 ●	50
954712	8,0 x 340	TX40 ●	50
954713	8,0 x 360	TX40 ●	50
954714	8,0 x 380	TX40 ●	50
954715	8,0 x 400	TX40 ●	50



# Technical information

## ECO PT, flanged button-head screw, blue galvanised

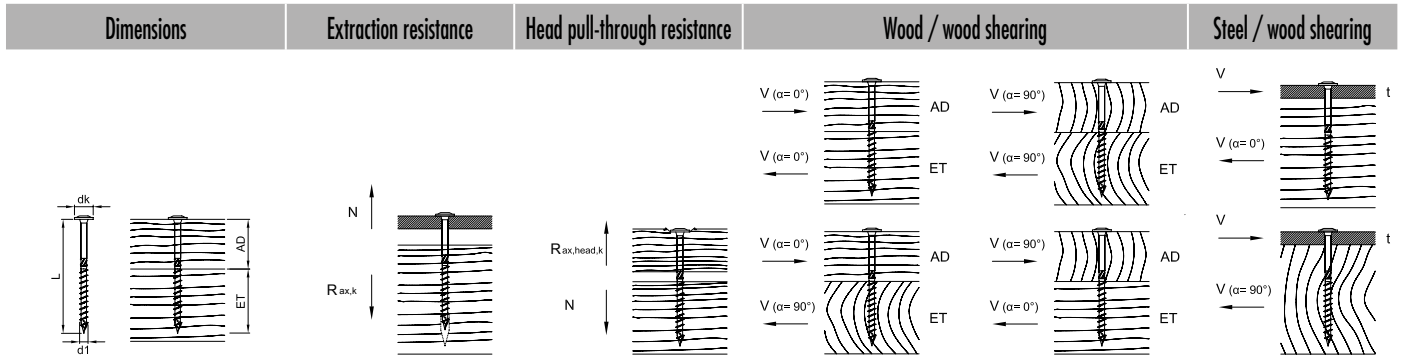

d1 x L [mm]	dk [mm]	AD [mm]	ET [mm]	R <sub>ax,k</sub> [kN]	R <sub>ax,head,k</sub> [kN]	R <sub>k</sub> [kN]				t [mm]	R <sub>k</sub> [kN]	
						α=0°	α=90°	α <sub>AD</sub> =0°	α <sub>AD</sub> =90°		α <sub>ET</sub> =90°	α <sub>ET</sub> =0°
8,0 x 80	22,0	32	48	4,26	5,81	4,27	3,41	4,27	3,41	4	4,56	3,94
8,0 x 100	22,0	40	60	4,83	5,81	4,83	4,01	4,83	4,01	4	4,83	4,20
8,0 x 120	22,0	60	60	5,33	5,81	4,83	4,20	4,83	4,20	4	4,83	4,20
8,0 x 140	22,0	60	80	7,10	5,81	4,95	4,32	4,95	4,32	4	5,28	4,65
8,0 x 160	22,0	80	80	7,10	5,81	4,95	4,32	4,95	4,32	4	5,27	4,65
8,0 x 180	22,0	100	80	7,10	5,81	4,95	4,32	4,32	4,95	4	5,27	4,65
8,0 x 200	22,0	120	80	7,10	5,81	4,95	4,32	4,32	4,95	4	5,27	4,65
8,0 x 220	22,0	140	80	7,10	5,81	4,95	4,32	4,32	4,95	4	5,27	4,65
8,0 x 240	22,0	160	80	7,10	5,81	4,95	4,32	4,32	4,95	4	5,27	4,65
8,0 x 260	22,0	180	80	7,10	5,81	4,95	4,32	4,32	4,95	4	5,27	4,65
8,0 x 280	22,0	200	80	7,10	5,81	4,95	4,32	4,32	4,95	4	5,27	4,65
8,0 x 300	22,0	220	80	7,10	5,81	4,95	4,32	4,32	4,95	4	5,27	4,65
8,0 x 320	22,0	240	80	7,10	5,81	4,95	4,32	4,32	4,95	4	5,27	4,65
8,0 x 340	22,0	260	80	7,10	5,81	4,95	4,32	4,32	4,95	4	5,27	4,65
8,0 x 360	22,0	280	80	7,10	5,81	4,95	4,32	4,32	4,95	4	5,27	4,65
8,0 x 380	22,0	300	80	7,10	5,81	4,95	4,32	4,32	4,95	4	5,27	4,65
8,0 x 400	22,0	320	80	7,10	5,81	4,95	4,32	4,32	4,95	4	5,27	4,65

Calculation according to ETA-11/0024. Wood density ρ<sub>W</sub>= 350 kg/m<sup>3</sup>. All mechanical values provided should be viewed as subject to the assumptions that have been made and represent example calculations.

All values are calculated minimum values and are subject to typographical and printing errors.

a) The characteristic values of the load-bearing capacity R<sub>k</sub> cannot be treated as equivalent to the max. possible load (the max. force). Characteristic values of the load-bearing capacity R<sub>k</sub> should be reduced to dimensioning values R<sub>d</sub> with regard to the usage class and class of the load duration: R<sub>d</sub>= R<sub>k</sub> · k<sub>mod</sub> / γ<sub>M</sub>. The dimensioning values of the load-bearing capacity R<sub>d</sub> should be contrasted with the dimensioning values of the loads (R<sub>d</sub> ≥ E<sub>d</sub>).

### Example:

Characteristic value for constant load (dead weight) G<sub>k</sub>= 2,00 kN and variable load (e. g. snow load) Q<sub>k</sub>= 3,00 kN. k<sub>mod</sub>= 0,9. γ<sub>M</sub>= 1,3.

→ Dimensioning value of the load E<sub>d</sub>= 2,00 · 1,35 + 3,00 · 1,5= 7,20 kN.

The load-bearing capacity of the joint is therefore considered to have been demonstrated if R<sub>d</sub> ≥ E<sub>d</sub> → min R<sub>d</sub>= R<sub>k</sub> · γ<sub>M</sub> / k<sub>mod</sub>

i.e. the characteristic minimum value is calculated based on: min R<sub>k</sub>= R<sub>d</sub> · γ<sub>M</sub> / k<sub>mod</sub> → R<sub>k</sub>= 7,20 kN · 1,3/0,9= 10,40 kN → comparison with table values.

Please note: These are planning aids. Projects must only be calculated by authorised persons.

## Angle-bracket screw

Blue galvanised



Art. no.	Dimensions [mm]	Drive	PU
945343	5,0 x 25	TX20	250
945232	5,0 x 35	TX20	250
945241	5,0 x 40	TX20	250
945233	5,0 x 50	TX20	250
945344	5,0 x 60	TX20	250
945345	5,0 x 70	TX20	250

## Technical information Angle-bracket screw, blue galvanised



Dimensions	Extraction resistance	Steel / wood shearing
------------	-----------------------	-----------------------

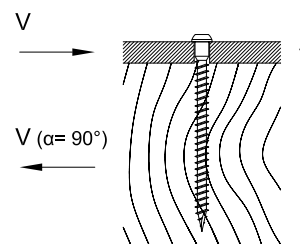
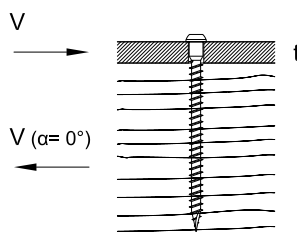
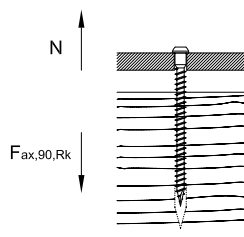
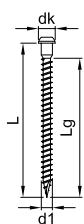

d1 x L [mm]	dk [mm]	Lg [mm]	F <sub>ax,90,Rk</sub> [kN]	t [mm]	R <sub>k</sub> [kN]	t [mm]	R <sub>k</sub> [kN]	t [mm]	R <sub>k</sub> [kN]	t [mm]	R <sub>k</sub> [kN]	t [mm]	R <sub>k</sub> [kN]
				t ≤ 9,0 [mm]			α = 0°		α = 0°		α = 0°		α = 0°
					α = 90°		α = 90°		α = 90°		α = 90°		α = 90°
5,0 x 25		16	0,97		0,89		0,87		0,85		0,96		1,18
5,0 x 35		26	1,57		1,27		1,25		1,23		1,35		1,59
5,0 x 40	7,2	31	1,88	1,5	1,46	2,0	1,44	2,5	1,42	3,0	1,55	4,0	1,81
5,0 x 50		41	2,48		1,84		1,82		1,80		1,89		2,10
5,0 x 60		51	3,09		1,99		1,99		1,99		2,09		2,29
5,0 x 70		61	3,69		2,14		2,14		2,14		2,24		2,44

Calculation according to ETA-11/0024. Wood density ρ<sub>w</sub> = 350 kg/m<sup>3</sup>. All mechanical values provided should be viewed as subject to the assumptions that have been made and represent example calculations.

All values are calculated minimum values and are subject to typographical and printing errors.

a) The characteristic values of the load-bearing capacity R<sub>k</sub> cannot be treated as equivalent to the max. possible load (the max. force). Characteristic values of the load-bearing capacity R<sub>k</sub> should be reduced to dimensioning values R<sub>d</sub> with regard to the usage class and class of the load duration: R<sub>d</sub> = R<sub>k</sub> · k<sub>mod</sub> / γ<sub>M</sub>. The dimensioning values of the load-bearing capacity R<sub>d</sub> should be contrasted with the dimensioning values of the loads (R<sub>d</sub> ≥ E<sub>d</sub>).

### Example:

Characteristic value for constant load (dead weight) G<sub>k</sub> = 2,00 kN and variable load (e. g. snow load) Q<sub>k</sub> = 3,00 kN. k<sub>mod</sub> = 0,9, γ<sub>M</sub> = 1,3.

→ Dimensioning value of the load E<sub>d</sub> = 2,00 · 1,35 + 3,00 · 1,5 = 7,20 kN.

The load-bearing capacity of the joint is therefore considered to have been demonstrated if R<sub>d</sub> ≥ E<sub>d</sub>. → min R<sub>k</sub> = R<sub>d</sub> · γ<sub>M</sub> / k<sub>mod</sub>

i.e. the characteristic minimum value is calculated based on: min R<sub>k</sub> = R<sub>d</sub> · γ<sub>M</sub> / k<sub>mod</sub> → R<sub>k</sub> = 7,20 kN · 1,3 / 0,9 = 10,40 kN → comparison with table values.

Please note: These are planning aids. Projects must only be calculated by authorised persons.

# Paneltwistec slate screw, Wing-tipped drilling screw

## Paneltwistec slate screw

Flanged button-head screw, hardened stainless steel

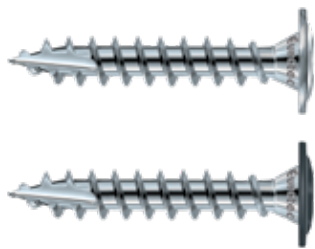

Stainless Steel

### For the optimum attachment of slate roof coverings

- Suitable for wooden or pilot-drilled aluminium substructures, as well as for single or double slate coverings
- Low exertion of force required to insert screws
- The saucer-shaped head's optimum fit prevents the wood from splitting
- Coloured head available in slate grey
- Head diameter Ø 10 mm
  - The wider diameter of the head delivers considerably higher torque and head pull-through capacity
  - This makes for better use of the screw's tensile load-bearing capacity
- Stainless steel in accordance with DIN 10088
- **Note:** However, you should ensure that your cordless screwdriver is correctly adjusted so that the screws are never overtightened



Art. no.	Dimensions [mm]	Drive	PU
945868	4,0 x 30	TX20 ●	500
945868-Grey	4,0 x 30	TX20 ●	500
945865	4,0 x 50	TX20 ●	500
945865-Grey	4,0 x 50	TX20 ●	500

## Wing-tipped drilling screw

Hardened stainless steel or blue galvanised



- No pilot-drilling necessary – the wings drill the timber wider than the thread diameter
- The screw drills/cuts its own core hole and mating thread in the steel
- Screws made of galvanised carbon steel or hardened stainless steel according to DIN 10088
- Hardened stainless steel can be magnetised
- Galvanised steel and hardened stainless steel are not resistant to acids. They are therefore also not suitable for fastening woods that contain tannin (e. g. oak)
- **The screw is suitable for outdoor use only for steel / wood connections with one screw per fixing point**
- Not suitable for dynamically loaded connections, e. g. bridge flooring

Art. no.	Dimensions [mm]	Drive	Clamping thickness <sup>a)</sup>	Drilling capacity	PU
<b>Hardened stainless steel</b>					
901990	4,8 x 38	TX25 ●	20	4	200
111404	5,5 x 45	TX30 ●	25	5	200
111405	5,5 x 50	TX30 ●	30	5	200
111406	6,3 x 60	TX30 ●	35	6	200
901585*	6,3 x 70	TX30 ●	45	6	200
904333*	6,3 x 80	TX30 ●	55	6	200
901581	6,3 x 85	TX30 ●	60	6	100
901584	6,3 x 110	TX30 ●	85	6	100
<b>Blue galvanised</b>					
111841	4,2 x 32	TX20 ●	15	3	500
111842	4,2 x 38	TX20 ●	20	3	500
111843	4,8 x 45	TX25 ●	25	4	500
111844	5,5 x 50	TX30 ●	30	5	200
111409	5,5 x 60	TX30 ●	40	5	200
111410	5,5 x 70	TX30 ●	50	5	200
111411	5,5 x 80	TX30 ●	60	5	200
111412	5,5 x 100	TX30 ●	80	5	200
111408	5,5 x 120	TX30 ●	100	5	200
111845	6,3 x 50	TX30 ●	25	6	200
111846	6,3 x 60	TX30 ●	35	6	200
111847	6,3 x 70	TX30 ●	45	6	200
111848	6,3 x 80	TX30 ●	55	6	200
111414	6,3 x 100	TX30 ●	75	6	200
111415	6,3 x 120	TX30 ●	95	6	200

a) Clamping thickness = mounted part thickness + plate thickness t; t<sub>max</sub> = drilling capacity

\*Discontinued item

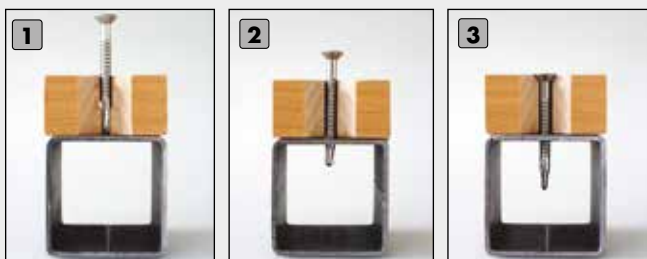

# Spacer screw, Mini spacer screw, FuboFix, Justitec

## Spacer screw

Galvanised steel, waxed



Art. no.	Dimensions [mm] <sup>a)</sup>	Drive	Adjustment range [mm]	PU
110099	6/10,0 x 60/20	TX25 •	0 - 15	200
110100	6/10,0 x 70/20	TX25 •	15 - 25	200
110101	6/10,0 x 80/20	TX25 •	15 - 35	200
110102	6/10,0 x 90/20	TX25 •	25 - 45	200
110103	6/10,0 x 100/20	TX25 •	35 - 55	200
110104	6/10,0 x 120/20	TX25 •	55 - 75	100
110105	6/10,0 x 135/20	TX25 •	70 - 90	100
110106	6/10,0 x 150/20	TX25 •	75 - 105	100
110107	6/10,0 x 180/20	TX25 •	100 - 135	100
110108	6/10,0 x 200/20	TX25 •	135 - 155	100

a) Ø Screw thread / Ø Head thread x screw length/head thread length

## Mini spacer screw

Galvanised steel, waxed



Art. no.	Dimensions [mm] <sup>a)</sup>	Drive	Adjustment range [mm]	PU
110121	4,5/8,0 x 60	TX25 •	0 - 15	100
110122	4,5/8,0 x 80	TX25 •	15 - 35	100
110123	4,5/8,0 x 100	TX25 •	35 - 55	100
110124	4,5/8,0 x 120	TX25 •	55 - 75	100

a) Ø Screw thread / Ø Head thread x screw length

### Fields of application

Spacer screws for stress-free installation of wooden windows, aluminium/plastic windows and doors, as well as for fastening timber frames in wall and ceiling panelling and for ridge- and hip-batten installation

## FuboFix

Chipboard screw, blue galvanised

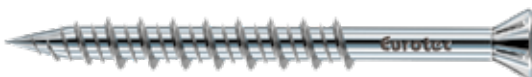

Art. no.	Dimensions [mm]	Drive	PU
945244-2	4,2 x 25	TX20 •	1000
945245-2	4,2 x 35	TX20 •	1000
945246-2	4,2 x 45	TX20 •	1000
945247-2	4,2 x 55	TX20 •	1000
945248-2	4,2 x 75	TX20 •	500

## FloorFix A2

A2 Stainless steel, ornamental head

**Stainless Steel**



Art. no.	Dimensions [mm]	Drive	PU*
945194	4,2 x 42	TX20 •	250
945195	4,2 x 55	TX20 •	250
945196	4,8 x 75	TX20 •	250

\* Delivered in a plastic bucket, inkl. 1 TX-Bit

- Only suitable for the use in softwood
- Limited resistance to acid
- Not suitable for atmospheres containing chlorine



## FloorFix A4

Stainless Steel A4, ornamental head

Stainless Steel



- Only suitable for the use in softwood
- Limited resistance to acid
- Suitable for use with woods containing tanning agents such as cumarú, oak, merbau, robinia, etc.
- Suitable for saline atmospheres
- Not suitable for atmospheres containing chlorine



Art. no.	Dimensions [mm]	Drive	PU*
945190	4,2 x 42	TX20 ●	250
945191	4,2 x 55	TX20 ●	250
945192	4,8 x 75	TX20 ●	250

\* Delivered in a plastic bucket, inkl. 1 TX-Bit

## FloorFix 1000

Special coated steel, ornamental head



- Only suitable for the use in softwood
- Corrosion-resistant up to 1000 h in salt spray test



Art. no.	Dimensions [mm]	Drive	PU*
945197	4,2 x 42	TX20 ●	250
945198	4,2 x 55	TX20 ●	250
945199	4,8 x 75	TX20 ●	250

\* Delivered in a plastic bucket, inkl. 1 TX-Bit

## Justitec

Galvanised steel, waxed, countersunk-head screw



- No pilot-drilling necessary, infinitely adjustable
- No need to lay wedges underneath – work is carried out timber on timber



Art. no.	Dimensions [mm]	Drive	Adjustment range [mm]	PU
111804	6,0 x 60	TX25 ●	0 - 10	200
111805	6,0 x 70	TX25 ●	0 - 20	200
111806	6,0 x 80	TX25 ●	0 - 30	200
111807	6,0 x 90	TX25 ●	0 - 40	100
111808	6,0 x 100	TX25 ●	0 - 50	100
111824	6,0 x 110	TX25 ●	0 - 60	100
111809	6,0 x 120	TX25 ●	0 - 70	100
905632	6,0 x 130	TX25 ●	0 - 80	100
905633	6,0 x 145	TX25 ●	0 - 95	100
905634	6,0 x 160	TX25 ●	0 - 110	100



# Paneltwistec 1000, Panhead TX, Assembly screws

## Paneltwistec 1000

Countersunk-head screw, special coated steel



- Corrosion-resistant up to 1000 h in salt spray test



Art. no.	Dimensions [mm]	Drive	PU
R945035	3,0 x 16	TX10 ○	1000
R903038	3,0 x 20	TX10 ○	1000
R903039	3,0 x 25	TX10 ○	1000
R903040	3,0 x 30	TX10 ○	1000
R903041	3,0 x 35	TX10 ○	1000
R903042	3,0 x 40	TX10 ○	1000
R945036	3,5 x 12	TX20 ●	1000
R945037	3,5 x 16	TX20 ●	1000
R903043	3,5 x 20	TX20 ●	1000
R903044	3,5 x 25	TX20 ●	1000
R903045	3,5 x 30	TX20 ●	1000
R903046	3,5 x 35	TX20 ●	1000
R903047	3,5 x 40	TX20 ●	1000
R903048	3,5 x 50	TX20 ●	500
R945038	4,0 x 16	TX20 ●	1000
R903001	4,0 x 20	TX20 ●	1000
R903002	4,0 x 25	TX20 ●	1000
R903003	4,0 x 30	TX20 ●	1000
R903049	4,0 x 35	TX20 ●	1000
R903004	4,0 x 40	TX20 ●	1000
R902089	4,0 x 45	TX20 ●	500
R903005	4,0 x 50	TX20 ●	500
R903006	4,0 x 60	TX20 ●	200
R903007	4,0 x 70	TX20 ●	200
R903008	4,0 x 80	TX20 ●	200
R945039	4,5 x 16	TX20 ●	1000
R903050	4,5 x 25	TX20 ●	500
R903051	4,5 x 30	TX20 ●	500
R903052	4,5 x 35	TX20 ●	500
R903009	4,5 x 40	TX20 ●	500
R903010	4,5 x 50	TX20 ●	500
R903011	4,5 x 60	TX20 ●	200
R903012	4,5 x 70	TX20 ●	200
R903013	4,5 x 80	TX20 ●	200
R903468	4,5 x 90	TX20 ●	200
R903063	4,5 x 100	TX20 ●	200
R903053	5,0 x 25	TX20 ●	500
R903054	5,0 x 30	TX20 ●	500
R903055	5,0 x 35	TX20 ●	500
R903014	5,0 x 40	TX20 ●	200
R903579	5,0 x 45	TX20 ●	200
R903015	5,0 x 50	TX20 ●	200
R903016	5,0 x 60	TX20 ●	200
R903017	5,0 x 70	TX20 ●	200
R903018	5,0 x 80	TX20 ●	200
R903578	5,0 x 90	TX20 ●	200
R903019	5,0 x 100	TX20 ●	200
R903020	5,0 x 120	TX20 ●	200
R903581	6,0 x 40	TX30 ●	200
R903582	6,0 x 50	TX30 ●	200
R903021	6,0 x 60	TX30 ●	200
R903022	6,0 x 70	TX30 ●	200
R903023	6,0 x 80	TX30 ●	200
R903163	6,0 x 90	TX30 ●	100
R903024	6,0 x 100	TX30 ●	100
R903025	6,0 x 120	TX30 ●	100
R903026	6,0 x 130	TX30 ●	100

More sizes on the next page

## Paneltwistec 1000

Flanged button-head screw, special coated steel



For the screws with a diameter of 8,0 and 10,0 mm

- Also suitable for fastening over-rafter insulation
- The larger head diameter allows for considerably higher torque and head pull-through capacity
- Better use of the screw's tensile load-bearing strength



Art. no.	Dimensions [mm]	Drive	PU
R903027	6,0 x 140	TX30 ●	100
R903029	6,0 x 160	TX30 ●	100
R903031	6,0 x 180	TX30 ●	100
R903032	6,0 x 200	TX30 ●	100
R903033	6,0 x 220	TX30 ●	100

Art. no.	Dimensions [mm]	Drive	PU
R901357	6,0 x 100	TX30 ●	100
R901359	6,0 x 120	TX30 ●	100
R901361	6,0 x 140	TX30 ●	100
R901364	6,0 x 180	TX30 ●	100
R901365	6,0 x 200	TX30 ●	100
R903060	8,0 x 80	TX40 ●	50
R903062	8,0 x 100	TX40 ●	50
R903064	8,0 x 120	TX40 ●	50
R903066	8,0 x 140	TX40 ●	50
R903067	8,0 x 160	TX40 ●	50
R903470	8,0 x 180	TX40 ●	50
R903069	8,0 x 200	TX40 ●	50
R903472	8,0 x 220	TX40 ●	50
R903071	8,0 x 240	TX40 ●	50
R903072	8,0 x 260	TX40 ●	50
R903073	8,0 x 280	TX40 ●	50
R903074	8,0 x 300	TX40 ●	50
R903475	8,0 x 360	TX40 ●	50
R903476	8,0 x 400	TX40 ●	50
R903077	10,0 x 60	TX40 ●	50
R903079	10,0 x 80	TX40 ●	50
R903081	10,0 x 100	TX40 ●	50
R903083	10,0 x 120	TX40 ●	50
R903085	10,0 x 160	TX40 ●	50
R903086	10,0 x 180	TX40 ●	50
R903087	10,0 x 200	TX40 ●	50
R903088	10,0 x 220	TX40 ●	50
R903089	10,0 x 240	TX40 ●	50

## Panhead TX

Chipboard screw, blue galvanised

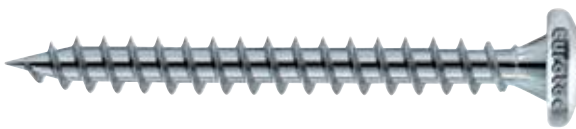

- Fully threaded screws
- Panhead
- Chipboard screw for indoor use

Art. no.	Dimensions [mm]	Drive	PU
111158	3,0 x 20	TX10 ○	1000
111159	3,0 x 25	TX10 ○	1000
111160	3,0 x 30	TX10 ○	1000
904523	3,5 x 16	TX15 ●	1000
111164	3,5 x 20	TX15 ●	1000
111165	3,5 x 25	TX15 ●	1000
111166	3,5 x 30	TX15 ●	1000
111167	3,5 x 35	TX15 ●	1000
111168	3,5 x 40	TX15 ●	1000
900033	4,0 x 16	TX20 ●	500
944777	4,0 x 20	TX20 ●	500
900034	4,0 x 25	TX20 ●	500
900035	4,0 x 30	TX20 ●	500
944808	4,0 x 35	TX20 ●	500
900036	4,0 x 40	TX20 ●	500
944809	4,0 x 45	TX20 ●	500
900037	4,0 x 50	TX20 ●	500
111186	4,5 x 20	TX25 ●	1000
111187	4,5 x 25	TX25 ●	1000
111188	4,5 x 30	TX25 ●	1000
111189	4,5 x 35	TX25 ●	1000
111190	4,5 x 40	TX25 ●	500
111191	4,5 x 45	TX25 ●	500

More sizes on the next page

Art. no.	Dimensions [mm]	Drive	PU
111192	4,5 x 50	TX25 ●	500
111198	5,0 x 17	TX25 ●	500
111199	5,0 x 20	TX25 ●	500
111200	5,0 x 25	TX25 ●	500
111201	5,0 x 30	TX25 ●	500
111202	5,0 x 35	TX25 ●	500
111203	5,0 x 40	TX25 ●	200
111204	5,0 x 45	TX25 ●	200
111205	5,0 x 50	TX25 ●	200
111206	5,0 x 60	TX25 ●	200
111211	6,0 x 40	TX25 ●	200
111212	6,0 x 50	TX25 ●	200
111213	6,0 x 60	TX25 ●	200
111234	6,0 x 80	TX25 ●	200

Art. no.	Dimensions [mm]	Drive	PU
R903090	3,5 x 16	TX20 ●	1000
R903091	3,5 x 20	TX20 ●	1000
R903092	3,5 x 25	TX20 ●	1000
R903093	3,5 x 30	TX20 ●	1000
R903094	3,5 x 35	TX20 ●	1000
R903095	3,5 x 40	TX20 ●	1000
R903096	4,0 x 20	TX20 ●	1000
R903097	4,0 x 25	TX20 ●	1000
R903098	4,0 x 30	TX20 ●	1000
R903099	4,0 x 35	TX20 ●	1000
R903100	4,0 x 40	TX20 ●	500
R903101	4,0 x 50	TX20 ●	500
R903102	4,0 x 60	TX20 ●	200
R903103	4,5 x 20	TX20 ●	500
R903104	4,5 x 25	TX20 ●	500
R903105	4,5 x 30	TX20 ●	500
R903106	4,5 x 35	TX20 ●	500
R903107	4,5 x 40	TX20 ●	500
R903108	4,5 x 50	TX20 ●	200
R903109	4,5 x 60	TX20 ●	200
R903110	5,0 x 20	TX20 ●	500
R903111	5,0 x 25	TX20 ●	500
R903112	5,0 x 30	TX20 ●	500
R903113	5,0 x 40	TX20 ●	200
R903114	5,0 x 50	TX20 ●	200
R903115	5,0 x 60	TX20 ●	200
R903116	5,0 x 70	TX20 ●	200
R903117	5,0 x 80	TX20 ●	200
R903118	6,0 x 40	TX30 ●	200
R903119	6,0 x 50	TX30 ●	200
R903120	6,0 x 60	TX30 ●	200

Art. no.	Dimensions [mm]	PU
111255	6,3 x 40	100
111256	6,3 x 50	100
111257	6,3 x 60	100
111258	6,3 x 75	100
111259	6,3 x 100	100

## Panhead TX 1000

Chipboard screw, special coated steel

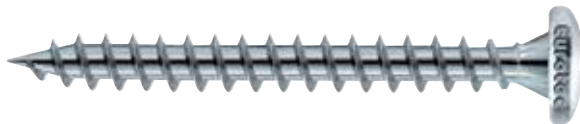

- Fully threaded screws
- Panhead
- Chipboard screw for outdoor use

## Assembly screw

Blue galvanised







# Universal wood construction screw

Collated screw for timber frame and solid wood construction

## HBS

In magazines, blue galvanised



Art. no.	Dimensions [mm]	Drive	PU
945080	4,2 x 41	PH 2	1000
945081	4,2 x 55	PH 2	1000

### Material

- For use in service class 1 and 2 conditions in accordance with DIN EN 1995 (Eurocode 5)
- High mechanical load bearing capacity
- Without chromium (VI) oxidised

### Advantages

- Universal application
- Quick to use in magazines
- Ridges under the head ensure optimal hold in magazines
- Milling ribs below the countersunk head prevents wood from splitting when being screwed in

### Suitable for universal use, e.g.

- For fastening wood-based panels to wooden substructures
- For fastening in timber frame and solid wood construction

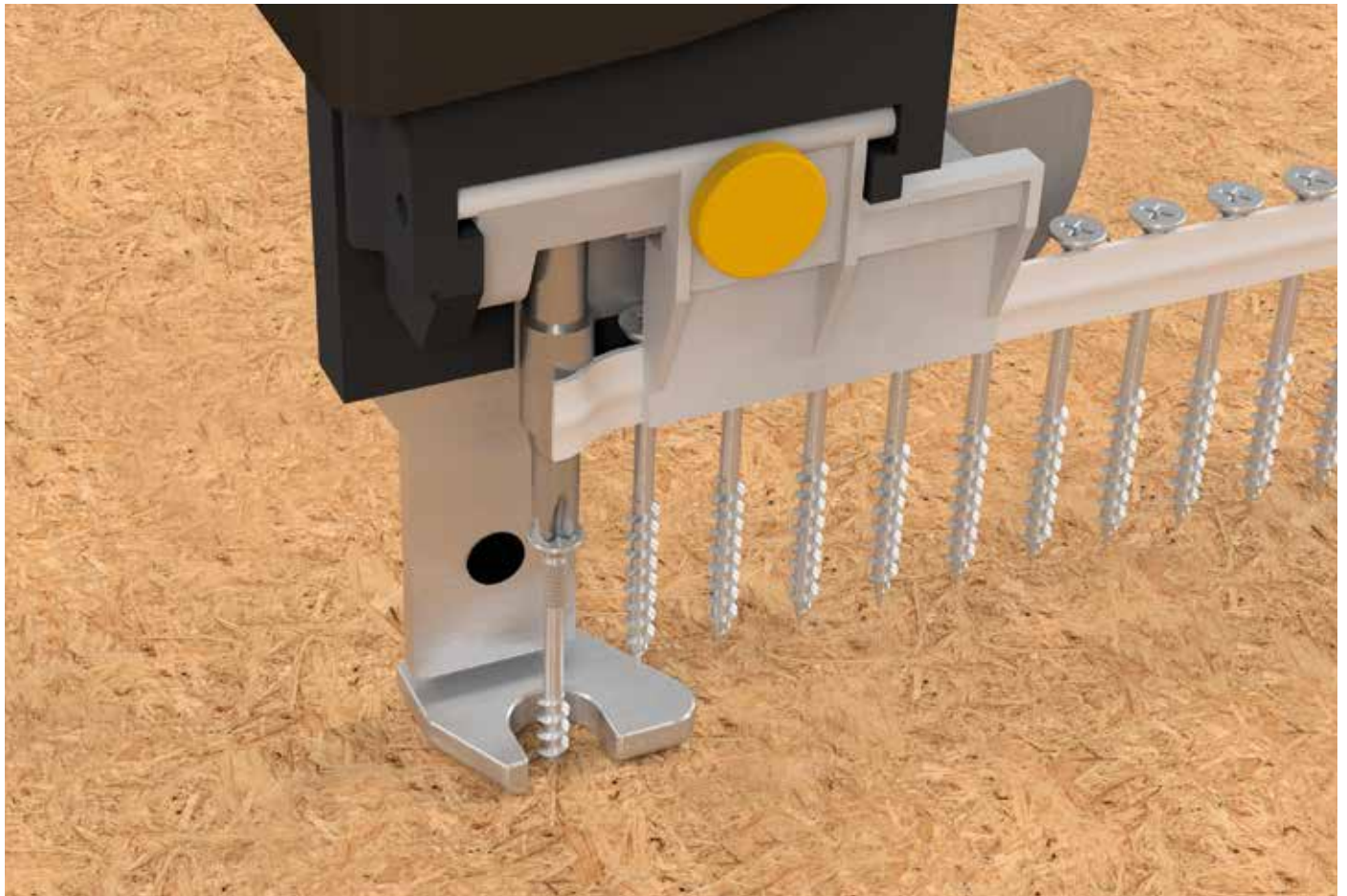

# Drywall screws

Screws for fast plasterboard fixation



## Drywall screw with fine thread

Phosphated in black



Art. no.	Dimensions [mm]	Drive	PU
903900	3,5 x 25	PH 2	1000
903901	3,5 x 35	PH 2	1000
903902	3,5 x 45	PH 2	500
903903	3,5 x 55	PH 2	500
903904	3,9 x 25	PH 2	1000
903905	3,9 x 30	PH 2	1000
903906	3,9 x 35	PH 2	1000
903907	3,9 x 40	PH 2	1000
903908	3,9 x 45	PH 2	500
903909	3,9 x 55	PH 2	500
<b>Coiled in black</b>			
903923	3,5 x 25	PH 2	1000
903924	3,5 x 35	PH 2	1000
903925	3,9 x 25	PH 2	1000
903926	3,9 x 35	PH 2	1000

## Drywall screw with coarse thread

Phosphated in black



Art. no.	Dimensions [mm]	Drive	PU
903910	3,9 x 25	PH 2	1000
903911	3,9 x 30	PH 2	1000
903912	3,9 x 35	PH 2	1000
903913	3,9 x 40	PH 2	1000
903914	3,9 x 45	PH 2	500
903915	3,9 x 55	PH 2	500
<b>Coiled in black</b>			
903927	3,5 x 25	PH 2	1000
903928	3,5 x 35	PH 2	1000
903929	3,9 x 25	PH 2	1000
903930	3,9 x 35	PH 2	1000

## Drywall screw with drill tip

Phosphated in black



Art. no.	Dimensions [mm]	Drive	PU
903916	3,5 x 25	PH 2	1000
903917	3,5 x 35	PH 2	1000
903918	3,5 x 45	PH 2	1000
<b>Coiled in black</b>			
903931	3,5 x 25	PH 2	1000
903932	3,5 x 35	PH 2	1000

## Drywall screw with Hi-Lo thread

Phosphated in black



Art. no.	Dimensions [mm]	Drive	PU
903919	3,9 x 19	PH 2	1000
903920	3,9 x 30	PH 2	1000
903921	3,9 x 45	PH 2	500
903922	3,9 x 55	PH 2	500
<b>Coiled in black</b>			
903933	3,9 x 19	PH 2	1000
903934	3,9 x 30	PH 2	1000

### Advantages of all our drywall screws

- Quick and easy screwing-in
- Phosphated for corrosion protection during short-term exposure to moisture
- For use and processing in drywall and acoustic construction
- Thread and thread type for building materials standardised by the DIN 18182 standard

All drywall screws available in magazines too

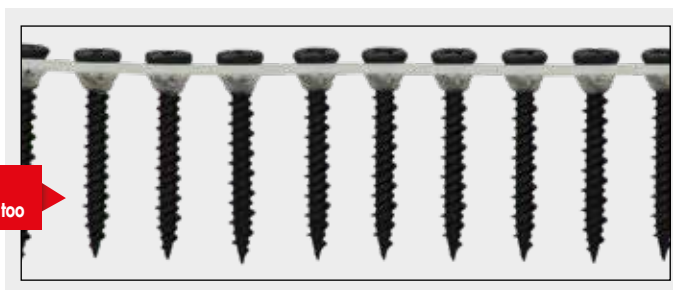

# Cavity dowel, Assembly pliers

## Cavity dowel

Blue galvanised



### Advantages

- High load-bearing capacity
- Fixing element easy to replace
- Ideal solution for every fastening in the cavity
- Spin lock prevents rotation in the building material
- Pre-assembled metric screw with cross recess drive
- Easy installation using assembly pliers or screwdriver

### Instructions for use

1. Pre-drill the drill hole
2. Guide the cavity dowel into the building material
3. Tighten the dowel until it is stuck
4. Unscrew the pre-assembled screw
5. Fix the component with a screw or another fixing element

### Application areas

- Gypsum plasterboard, plywood boards, chipboard, calcium silicate boards
- Indoor applications, e. g. pictures, shelves, lamps

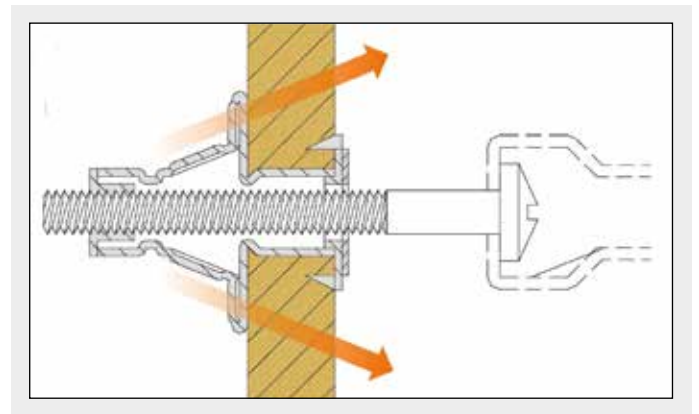

Art. no.	Dimensions [mm]	Sleeve length [mm]	Drill-Ø [mm]	Board thickness [mm]	Assembly pliers [mm]	PU
200227	4,0 x 32	33	8	4 - 9	41	100
200228	4,0 x 38	39	8	9 - 16	47	100
200229	4,0 x 46	46	8	16 - 22	54	100
200230	5,0 x 37	37	10	5 - 13	45	100
200231	5,0 x 52	53	10	5 - 18	60	100
200232	5,0 x 65	65	10	18 - 32	74	100
200233	6,0 x 37	37	12	5 - 12	45	100
200234	6,0 x 52	53	12	5 - 18	60	100
200235	6,0 x 65	66	12	18 - 32	74	100
200236	8,0 x 55	55	14	5 - 18	65	100
200237	8,0 x 65	68	14	18 - 32	75	100

## Assembly pliers

For Cavity dowel



Suitable  
for this

Art. no.	Description	PU
200226	For Cavity dowel	1



# Eurotec retail shelving unit

Small packages

## Advantages

With the new retail shelving unit from Eurotec, you will receive screws in the most common dimensions and materials sorted within a shelving unit. This allows you to equip your customers for everyday applications in timber-frame construction with just a single shelving unit.

- 1** The upper section of the shelving contains screws packed in bags of 10, 15, 20 or 45.
- 2** In the lower section, you will find screws packed in boxes of 50 or 100. All of the boxes have a resealable pourer opening.
- 3** This comprehensive shelving unit also includes bits, long bits and bit boxes in the matching TX sizes and featuring Eurotec's colour-guide system.

You will find the following screw types and dimensions in the shelving unit:

- Paneltwistec AG special coated,  
Countersunk head Ø 3,5 x 30 mm to Ø 6,0 x 120 mm
- EcoTec A2 chipboard screw,  
Countersunk head Ø 4,0 x 40 mm to Ø 6,0 x 120 mm
- Hapatec hardened stainless steel,  
Ornamental head Ø 4,0 x 30 mm to Ø 5,0 x 80 mm







### Eurotec

Maxi pack



## Eurotec Euro pallets Maxi packaging



### Euro pallet

With 8, 16 or 24 Eurotec Maxi packages











## Wood connector

Angle bracket	338
Angle-bracket screw	338
Interwoven fence fitting	338
Joist hangers	339
Bracing strap	339
Perforated mounting strips	340 - 341
H post anchor	342
Fence post connection screw	342
Pyramid post cap	343
Hammer-in ground sockets	343
Screw-on sockets	344
Post holders	344 - 345
Corner connectors	345
U brackets	345
Post support 135 + 65	346
EckTec	346
Threaded rod	347
Hex nuts	347
Washer	347
Anchor nails	347

# Angle bracket, Angle-bracket screw, Interwoven fence fitting

## Angle bracket

With a rib, hot-dip galvanised steel



- High stability thanks to reinforced rib
- Excellent corrosion protection thanks to hot-dip galvanisation

## Angle-bracket screw

Blue galvanised



## Interwoven fence fitting set

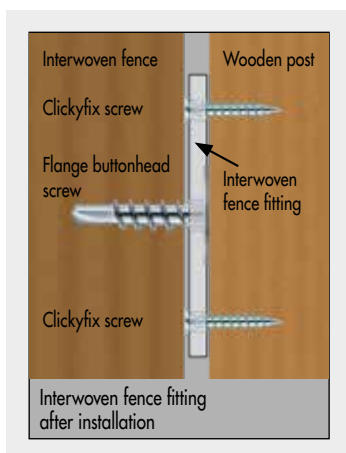

## Interwoven fence fitting

Yellow galvanised steel



Art. no.	Dimensions [mm] <sup>a)</sup>	Drill holes [mm] <sup>b)</sup>	PU
904725	70 x 70 x 55	12 x 5 / 2 x 11	100
904726	90 x 90 x 65	20 x 5 / 2 x 11	100
904727	100 x 100 x 90	28 x 5 / 6 x 11	50
904729	110 x 170 x 95	53 x 5 / 9 x 13	25

a) Length x height x width  
b) Number x Ø

Art. no.	Dimensions [mm]	Drive	PU
945343	5,0 x 25	TX20	250
945232	5,0 x 35	TX20	250
945241	5,0 x 40	TX20	250
945233	5,0 x 50	TX20	250
945344	5,0 x 60	TX20	250
945345	5,0 x 70	TX20	250

Art. no.	Dimensions [mm]	Material	PU
S900335*	40 x 65 mm	A2	1

\*A set consists of 4 fittings (A2) + 16 ClickyFix + 4 x Interwoven fence screws



Screw the interwoven fence fitting with an interwoven fence screw at the head to the fence element. We recommend at least two fittings per side, ie 4 fittings for each fence element



Now fasten the fence panel with the fitting to the wooden post. We recommend using 4 Clickyfix screws per fitting

Art. no.	Dimensions [mm] <sup>a)</sup>	Material thickness [mm]	PU
900337	36 x 83 x 27	2,0	4

a) Height x length x width



# Joist hangers, Bracing strap

## Outer joist hangers



## Inner joist hangers



## Technical data for the outer/inner joist hanger

Art. no.	Item description	Dimensions [mm] <sup>a)</sup>	Material thickness [mm]	nH <sup>1</sup> (Ø 5)	nN <sup>2</sup> (Ø 5)	nH <sup>1</sup> (Ø 11)	PU
904629	Outer joist hangers	40 x 110	2	14	8	4 x Ø9	50
904642	Outer joist hangers	45 x 108	2	14	8	4 x Ø9	50
904630	Outer joist hangers	70 x 125	2	18	10	4	50
904631	Outer joist hangers	80 x 120	2	18	10	4	50
904632	Outer joist hangers	90 x 145	2	22	12	4	50
904633	Outer joist hangers	100 x 140	2	22	12	4	50
904634	Outer joist hangers	120 x 160	2	26	14	6	20
904635	Outer joist hangers	140 x 180	2	30	16	6	20
904628	Inner joist hangers	40 x 110	2	8	8	–	50
904636	Inner joist hangers	70 x 125	2	10	10	4	50
904637	Inner joist hangers	80 x 120	2	18	10	4	50
904638	Inner joist hangers	90 x 145	2	22	12	4	50
904639	Inner joist hangers	100 x 140	2	22	12	4	50
904640	Inner joist hangers	120 x 160	2	26	14	6	20
904641	Inner joist hangers	140 x 180	2	30	16	6	20

a) Width x Height

1) nH: Number of holes in the brackets for the main girder

2) nS: Number of holes in the brackets for the secondary girder

## Bracing strap

With metre marking and galvanised edges



Art. no.	Dimensions [mm] <sup>a)</sup>	Material thickness [mm]	PU
904766	50000 x 40	1,5	1
904767	50000 x 60	1,5	1

a) Length x width

# Perforated mounting strips

**NEW**  
to our product range

## Perforated mounting strips

Plastic-coated



Art. no.	Dimensions [mm] <sup>a)</sup>	Hole-Ø [mm]	Coating	F <sub>Rk</sub> [N] <sup>b)</sup>	F <sub>Rd</sub> [N] <sup>c)</sup>	PU
944914	19 x 3 x 10.000	6,5	Plastic-coated	2938	2350	5

a) Width x strength x length

b) The characteristic values of the load-bearing capacity F<sub>Rk</sub> should not be treated as equivalent to the max. possible load (the max. force).

c) The characteristic load-bearing capacity is reduced by the material safety factor  $\gamma_m = 1,25$ .  
The rated tensile capacity F<sub>Rd</sub> is calculated as follows:  $F_{Rd} = F_{Rk} / \gamma_m$

### Product description

Eurotec perforated mounting strips serve as a reinforcement, connection or fastening element and help to keep things tidy when laying cables, so that you can work with straight lines and precision. This not only looks more professional, but also provides additional safety. The risk of accidentally drilling into cables is eliminated.

### Advantages

- Wide range of applications
- Can be used to fasten tubes and cables and for suspensions
- Practical dispenser box guarantees quick and straightforward handling

### Instructions for use

Plastic-coated perforated mounting strips must always be used when fastening pipes made from copper, as the two metals are not compatible when in direct contact (risk of contact corrosion).



## Perforated mounting strips

Galvanised



Art. no.	Dimensions [mm] <sup>a)</sup>	Hole-Ø [mm]	Coating	F <sub>Rk</sub> [N] <sup>b)</sup>	F <sub>Rd</sub> [N] <sup>c)</sup>	PU
944915	12 x 0,75 x 10.000	5,0	Galvanised	1416	1132	5
944916	17 x 0,75 x 10.000	6,5	Galvanised	2693	2154	5
944919	25 x 0,75 x 10.000	8,5	Galvanised	3120	2632	5

a) Width x strength x length

b) The characteristic values of the load-bearing capacity F<sub>Rk</sub> should not be treated as equivalent to the max. possible load (the max. force).

c) The characteristic load-bearing capacity is reduced by the material safety factor  $\gamma_m = 1,25$ .  
The rated tensile capacity F<sub>Rd</sub> is calculated as follows:  $F_{Rd} = F_{Rk} / \gamma_m$

### Product description

Eurotec perforated mounting strips serve as a reinforcement, connection or fastening element and help to keep things tidy when laying cables, so that you can work with straight lines and precision. This not only looks more professional, but also provides additional safety. The risk of accidentally drilling into cables is eliminated.

### Advantages

- Wide range of applications
- Can be used to fasten tubes and cables and for suspensions

### Instructions for use

Plastic-coated perforated mounting strips must always be used when fastening pipes made from copper, as the two metals are not compatible when in direct contact (risk of contact corrosion).

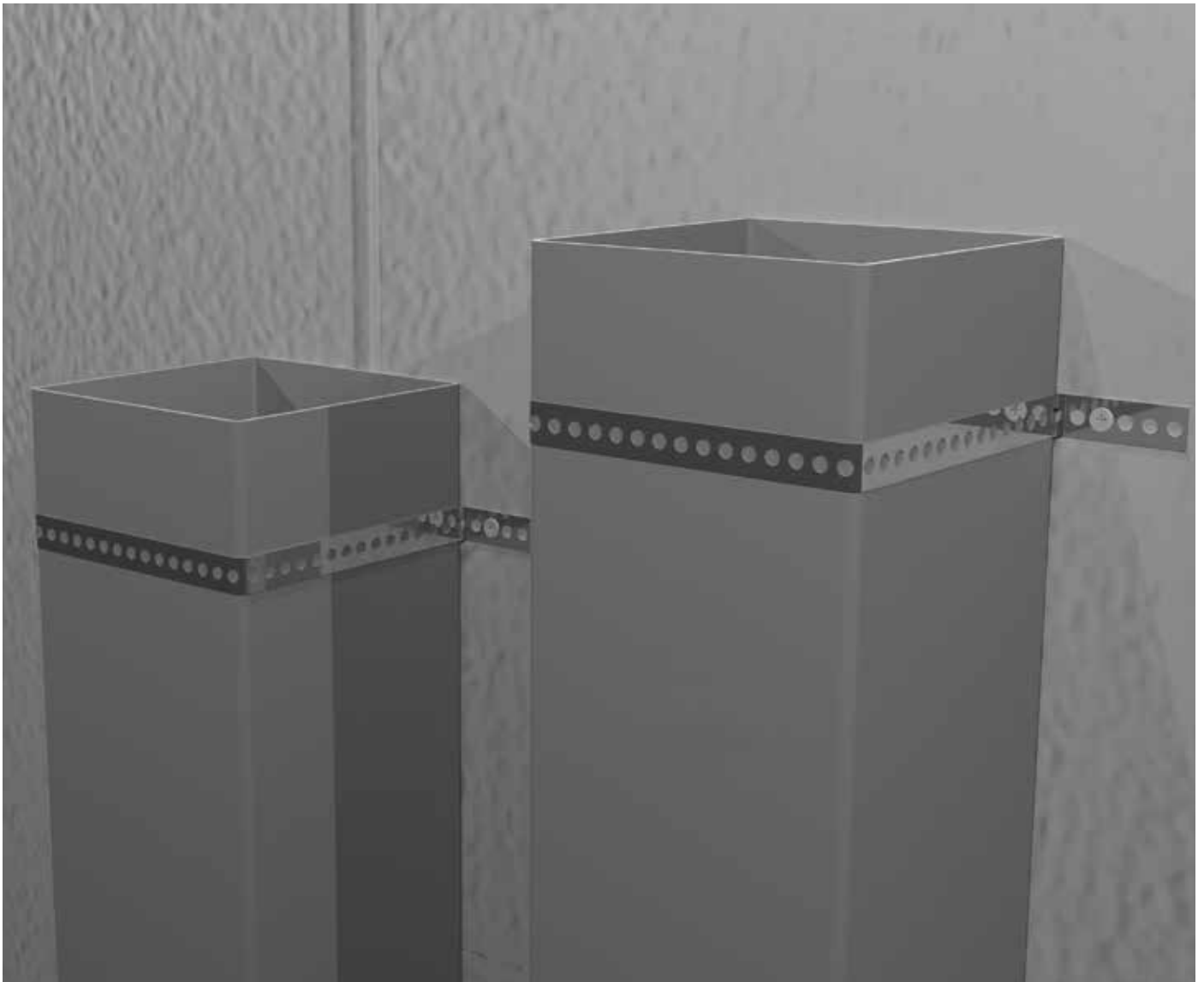

# H post anchor, Fence post connection screw, Pyramid post cap, Hammer-in ground sockets

## H post anchor

Hot-dip galvanised steel

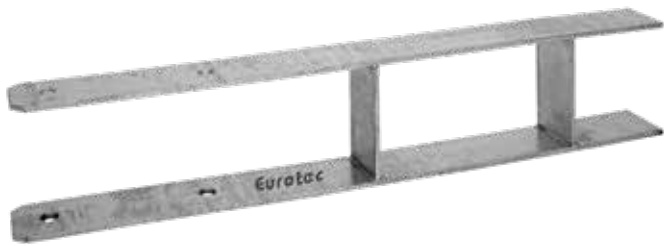

- For fixing square timber posts in place
- Fixed into concrete using H anchor
- Excellent corrosion protection thanks to hot-dip galvanisation

Art. no.	Fork width [mm]	Dimensions Overall/Post support [mm] <sup>a)</sup>	Drill holes Post support [mm] <sup>b)</sup>	PU
Material thickness: 6 mm				
904737	91	600 x 60 / 300	4 x 11	1
904738	101	600 x 60 / 300	4 x 11	1
904739	121	600 x 60 / 300	4 x 11	1
904740	141	600 x 60 / 300	4 x 11	1
Material thickness: 8 mm				
904741	161	800 x 60 / 400	4 x 11	1

a) Height x length/Length  
b) Number x Ø



## Fence post connection screw

Special coated

**Suitable for this**



- Flange buttonhead screws Ø 8 mm
- Head diameter Ø 22 mm
- Splitting effect reduced due to special tip geometry
- No pilot-drilling necessary
- Special protection against corrosion
- For use, e. g., in fence and pergola construction



Art. no.	Dimensions [mm]	Drive	PU
R903056	8 x 40	TX40 ●	100
R903057	8 x 50	TX40 ●	100
975594	10 x 40	TX40 ●	50
975595	10 x 50	TX40 ●	50

Not suitable for woods containing tanning agents!

## Fence-post connection screws

Stainless steel A2

**Suitable for this**



- Limited resistance to acid
- Not suitable for atmospheres containing chlorine



Art. no.	Dimensions [mm]	Drive	PU
975570	8 x 40	TX40 ●	100
975571	8 x 50	TX40 ●	100



## Pyramid post cap

Hot-dip galvanised steel



- To protect posts against the effects of weathering
- Visual enhancement thanks to pyramid shape
- Excellent corrosion protection thanks to hot-dip galvanisation

Art. no.	Dimensions [mm]	PU
904733	71 x 71	1
904734	91 x 91	1
904735	101 x 101	1

## Hammer-in ground socket

For square posts



- For fixing square timber posts in place
- Socket is fixed into the ground with ground anchors
- Excellent corrosion protection thanks to hot-dip galvanisation

Art. no.	Dimensions Post socket [mm] <sup>a)</sup>	Length Spike [mm]	Drill hole Post socket [mm] <sup>b)</sup>	PU
904703	150 x 71 x 71	750	4 x 11	1
904704	150 x 91 x 91	750	4 x 11	1
904730	150 x 101 x 101	750	4 x 11	1

a) Height x length x width  
b) Number x Ø

## Hammer-in ground socket

For round posts



- For fixing round timber posts into place
- Socket is fixed into the ground with ground anchors
- Excellent corrosion protection thanks to hot-dip galvanisation

Art. no.	Dimensions Post socket [mm] <sup>a)</sup>	Length Spike [mm]	Drill hole Post socket [mm] <sup>b)</sup>	PU
904705	81 x 150	450	4 x 11	1
904706	101 x 150	450	4 x 11	1
904707	121 x 145	605	4 x 11	1

a) Ø x Height  
b) Number x Ø



# Screw-on socket, Post holder movable

Hot-dip galvanised steel

## Screw-on socket

For square posts

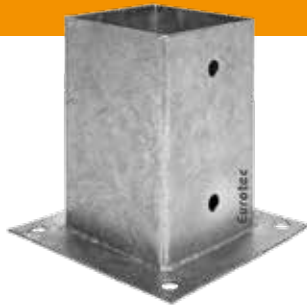

- For fixing square timber posts in place
- Socket is fastened to the subsurface with four screws
- Excellent corrosion protection thanks to hot-dip galvanisation

Art. no.	Dimensions Post socket [mm] <sup>a)</sup>	Dimensions Baseplate [mm] <sup>b)</sup>	Drill holes Baseplate/Post socket <sup>c)</sup>	PU
904695	150 x 71 x 71	150 x 150	4 x 11 / 4 x 11	1
904696	150 x 91 x 91	150 x 150	4 x 11 / 4 x 11	1
904697	150 x 101 x 101	150 x 150	4 x 11 / 4 x 11	1
904698	150 x 121 x 121	180 x 180	4 x 11 / 4 x 11	1
904736	150 x 141 x 141	200 x 200	4 x 11 / 4 x 11	1
904743	150 x 161 x 161	240 x 240	4 x 11 / 4 x 11	1
904747	150 x 181 x 181	280 x 280	4 x 11 / 4 x 11	1
904748	150 x 201 x 201	300 x 300	4 x 11 / 4 x 11	1

a) Height x length x width  
b) Length x width  
c) Number x Ø

## Screw-on socket

For round posts



- For fixing round timber posts into place
- Socket is fastened to the subsurface with four screws
- Excellent corrosion protection thanks to hot-dip galvanisation

Art. no.	Dimensions Post socket [mm] <sup>a)</sup>	Dimensions Baseplate [mm] <sup>b)</sup>	Drill holes Baseplate/Post socket <sup>c)</sup>	PU
904701	101 x 150	150 x 150	4 x 11 / 4 x 11	1
904702	121 x 147	180 x 180	4 x 11 / 4 x 11	1

a) Ø x height  
b) Length x width  
c) Number x Ø

## Post holder

Movable, for round posts



- For fixing round timber posts into place
- Socket is fastened to the subsurface with four screws
- Movable upper section allows attachment to inclined subsurfaces
- Excellent corrosion protection thanks to hot-dip galvanisation

Art. no.	Dimensions Post socket [mm] <sup>a)</sup>	Dimensions Baseplate [mm] <sup>b)</sup>	Drill holes Baseplate/Post socket <sup>c)</sup>	PU
904713	101 x 150	140 x 130	4 x 11 / 3 x 5	1
904714	121 x 150	160 x 150	4 x 11 / 3 x 5	1

a) Ø x height  
b) Length x width  
c) Number x Ø

## U post holder

Movable, for square posts



- For fixing square timber posts in place
- Socket is fastened to the subsurface with four screws
- Movable upper section allows attachment to inclined subsurfaces
- Excellent corrosion protection thanks to hot-dip galvanisation

Art. no.	Fork width [mm]	Length Post support [mm]	Dimensions Baseplate [mm] <sup>a)</sup>	Drill holes Baseplate/Post support [mm] <sup>b)</sup>	PU
904708	71	100	100 x 100	4 x 11 / 6 x 11	1
904709	91	100	100 x 100	4 x 11 / 6 x 11	1

a) Length x width  
b) Number x Ø

# U post holders, Corner connectors, U brackets

Hot-dip galvanised steel

## U post holder



- For fixing square timber posts in place
- The bracket is fastened to the subsurface with three screws
- Post supports in sides provide spacing between the ground and the timber profile, aiding constructive timber protection
- Excellent corrosion protection thanks to hot-dip galvanisation

Art. no.	Fork width [mm]	Dimensions Post support [mm] <sup>a)</sup>	Drill holes Baseplate/Post support [mm] <sup>b)</sup>	PU
904717	71	150 x 60	2 x 11 ; 1 x 14 / 6 x 11	1
904719	91	150 x 60	2 x 11 ; 1 x 14 / 6 x 11	1
904721	101	150 x 60	2 x 11 ; 1 x 14 / 6 x 11	1

a) Length x width  
b) Number x Ø

## U post holder

With stone pin



- For fixing square timber posts in place
- The bracket is fixed in the concrete with a 200 mm long stone pin
- Post supports in sides provide spacing between the ground and the timber profile, aiding constructive timber protection
- Excellent corrosion protection thanks to hot-dip galvanisation

Art. no.	Fork width [mm]	Dimensions Post support [mm] <sup>a)</sup>	Dimensions Stone pin [mm] <sup>b)</sup>	Drill holes Post support [mm] <sup>c)</sup>	PU
904716	71	150 x 60	16 x 200	6 x 11	1
904718	91	150 x 60	16 x 200	6 x 11	1
904720	101	150 x 60	16 x 200	6 x 11	1
904715	121	150 x 60	16 x 200	6 x 11	1

a) Length x width  
b) Ø x height  
c) Number x Ø

## Corner connector

For square posts



- For fixing square timber posts in place
- The corner connectors are fastened to the subsurface with four screws in total
- Allow variable width adjustment
- Excellent corrosion protection thanks to hot-dip galvanisation

Art.-Nr.	Dimensions Post socket [mm] <sup>a)</sup>	Dimensions Baseplate [mm] <sup>b)</sup>	Drill holes Baseplate/Post socket [mm] <sup>c)</sup>	PU
904710	200 x 105 x 105	82 x 155	2 x 11 / 6 x 11	1

a) Height x length x width  
b) Length x width  
c) Number x Ø

## U bracket

For fences



- For fixing round timber posts into place
- Corrosion protection

Art. no.	Fork width [mm]	Dimensions [mm] <sup>a)</sup>	Drill holes Post support [mm] <sup>b)</sup>	PU
904711	101	233 x 40	4 x 6	1
904712	121	270 x 40	4 x 6	1

a) Length x width  
b) Number x Ø

# Post support 135 + 65, EckTec

## Post support 135 + 65

Blue galvanised steel



### Advantages and properties

- Simple assembly with fully threaded screws and no need for joinery work, pilot-drilling or milling
- Min. timber cross section of 100 x 100 mm
- After assembly, height adjustable up to 65 mm
- Can be used in the usage classes 1 and 2 in accordance with DIN EN 1995-1-1

Art. no.	Dimensions of baseplate [mm] <sup>a)</sup>	PU
904749	6 x 160 x 80	1

a) Height x length x width

## Technical data: Post support 135 + 65

Name	Art. no.	Height adjustment in assembled state	Min. post cross section	Dimensions of baseplate	Compressive loadbearing capacity	Tensile loadbearing capacity	Lateral force resistance	PU
Post feet on concrete		[mm]	[mm]	H x L x W [mm]	$N_{c,d}$ [kN]	$N_{t,d}$ [kN]	$V_{e,d}$ [kN]	Piece
Post support 135 + 65	904749	135 - 200	100 x 100	6 x 160 x 80	40,0	6,1	0,8	1

## EckTec

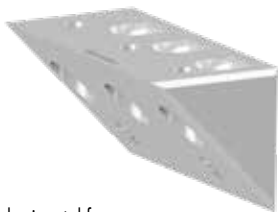

### Advantages

- Supports load absorption with horizontal forces
- Pre-assembly at the factory optional
- Many different areas of use

### Description

The EckTec connector can replace the conventional brace. This allows a better look without disruptive braces, especially at low installation heights.

Art. no.	Dimensions [mm] <sup>a)</sup>	PU*
975664	50 x 50 x 100	1

a) Width x height x depth  
\* Comes supplied with screws

Load capacities EckTec 100 Wood - C24, $\rho_k = 350 \text{ kg/m}^3$ ; $k_{mod} = 1,0$	$M_{1,Rd}$ [kNm]	$F_{1,Rd}$ [kN]
Torque	1,39	-
Torque and traction (combined)	0,96	8,4





# Threaded rod, Hex nuts, Washer, Anchor nails

## Threaded rod

DIN 976



Art. no.	Dimensions	Material	Strength class	PU
975700	M6	Galvanised steel	4.8	100
975701	M8	Galvanised steel	4.8	50
975702	M10	Galvanised steel	4.8	25
975703	M12	Galvanised steel	4.8	25
975704	M14	Galvanised steel	4.8	20
975705	M16	Galvanised steel	4.8	10
975706	M18	Galvanised steel	4.8	10
975707	M20	Galvanised steel	4.8	10
975708	M6	Galvanised steel	8.8	100
975709	M8	Galvanised steel	8.8	50
975710	M10	Galvanised steel	8.8	25
975711	M12	Galvanised steel	8.8	20
975712	M14	Galvanised steel	8.8	20
975713	M16	Galvanised steel	8.8	10
975714	M18	Galvanised steel	8.8	10
975715	M20	Galvanised steel	8.8	10

## Hex nuts

DIN 934



Art. no.	Dimensions	Material	Strength class	PU
800276	M6	Galvanised steel	8.8	200
800277	M8	Galvanised steel	8.8	200
800278	M10	Galvanised steel	8.8	100
800279	M12	Galvanised steel	8.8	100
800280	M14	Galvanised steel	8.8	50
800281	M16	Galvanised steel	8.8	50
800282	M18	Galvanised steel	8.8	50
800283	M20	Galvanised steel	8.8	25

## Washer

DIN 440, R shape



Art. no.	Dimensions	D1	D2	Material	PU
800250	M6	6,6	22	Galvanised steel	200
800251	M8	9	28	Galvanised steel	200
800252	M10	11	34	Galvanised steel	200
800253	M12	13,5	44	Galvanised steel	100
800256	M14	15,5	50	Galvanised steel	100
800254	M16	17,5	56	Galvanised steel	50
800255	M20	22	72	Galvanised steel	50

D1 = Inside diameter, D2 = Outside diameter

## Washer

Yellow/blue galvanised steel



Art. no.	Screw Ø	D1	D2	PU
<b>blue</b>				
903640	5,0	5,35	16	100
900098	6,0	8,0	20	50
900099	8,0	9,0	25	50
8901032	10,0	12,0	32	50
<b>yellow</b>				
900095	5,0	5,35	16	100
900096	6,0	8,0	20	50
900097	8,0	9,0	25	50
901032	10,0	12,0	32	50
900087	12,0	14,0	37	50

D1 = Inside diameter, D2 = Outside diameter

## Anchor nails

With flat head



Art. no.	Dimensions	Material	PU
200240	4,0 x 40	Galvanised	250
200241	4,0 x 50	Galvanised	250
200242	4,0 x 60	Galvanised	250







## Tools and aids for timber-frame construction

Bits and accessories	350 - 352
Beam grip, Slab grip, Bracing strap tensioner	353
ScrewFiX screw-in aid	354
Suction lifter	355
Fall arrest system	356
Work gloves	357 - 363
Protective helmet	364
Carpenter's hammer	365
Screw clamps and Steel screw clamp	365
Single-use lifting strap	366
Wall support	366
Round slings	367 - 368
Lashing strap	369 - 372
Transport anchor system	373
Cutter, Folding cutter/-set	374
Japanese saw	375
Multitool	375
Insulation knife	376
Ripsaw	376
Laser Rangefinder 50M	377
Cross-line laser, Combi Laser	378
Measuring tools	379 - 380
Ratchets	381
Hammer tacker	381
Auger bit/-set	382
Assembly wedges and Adjustment blocks	383 - 385

# Bits and accessories

Our colour-guide system will help you find the right bit quickly

## TX-Bit

1/4" x 25 mm



Art. no.	Size	Bit	PU
Length: 25 mm			
945851	TX10 ○		10
945852	TX15 ●		10
945853	TX20 ●		10
945854	TX25 ●		10
945855	TX30 ●		10
945856	TX40 ●		10

## TX-long-Bit

1/4" x 50 mm



Art. no.	Size	Bit	PU
Length: 50 mm			
954666	TX10 ○		20
945975	TX15 ●		20
945976	TX20 ●		20
945977	TX25 ●		20
945978	TX30 ●		20
945979	TX40 ●		20
954658	TX50 ●		10

### Advantage

A secure hold in every position!

### Description

The long bit is suitable for installing screws in hard-to-access places in all fastening areas, e. g. deck boards, cladding, etc. It is suitable for common electric/cordless screwdrivers and can therefore be used either directly or with an adapter.

- The long bit is well-suited to use in relatively inaccessible screw positions. Fastening can be achieved easily without the chuck damaging the boards.



**Hint**  
6 long bit packs (20 bits in one size) just plug them together and you get a practical storage box.

## Quick-change bit holder

Can be used for all 1/4" bits of any length



Art. no.	PU*
945850	1

\*Bit supplied separately

### Description

The Bit holder from Eurotec is an ideal aid for all craftsmen. Once the bit is inserted into the bit holder, it can no longer fall out of its own accord.



## Stainless steel TX-Bit

1/4" x 50 mm



### Advantages

- Protection against the risk of flash rust
- Avoidance of follow-up costs due to flash rust

Art. no.	Size	Bit	PU
500055	TX10 ○		20
500056	TX15 ●		20
500057	TX20 ●		20
500058	TX25 ●		20
500059	TX30 ●		20

## Magnet TX Long Bit

1/4" x 50 mm



### Contents

- 5 Magnet TX Long Bits in a practical blister pack with standard European perforation

### Advantages

- Extremely strong hold in every position
- No falling screws

### Description

The magnet bits from Eurotec provide an extremely strong hold and therefore prevent screws from falling. Even long screws remain securely in place and even in a horizontal position.

Art. no.	Size	Bit	PU
499993	TX10 ○		5
499994	TX15 ●		5
499995	TX20 ●		5
499996	TX25 ●		5
499997	TX30 ●		5
499998	TX40 ●		5

## Magnet Bit Set



6 sizes in a blister pack

Art. no.	Size	PU
499992	TX10 / TX15 / TX20 / TX25 / TX30 / TX40	6



## 12-in-1 ratchet screwdriver



### Advantages

- Ratchet function – no follow-up needed
- 12 bits in the extendible clip
- Ergonomic and non-slip handle

Art. no.	Dimensions [mm] <sup>a)</sup>	Weight [g]	PU
800490	250 x 35	265	1

a) Length x width



## Bit box

Specially made for wood construction



### Description

31 TX bits and 1 quick-change bit holder in a practical box with a belt clip.



Available to order individually or as a 10-pack incl. Sales display

Art. no.	Description (Content)	PU
945857	5 x TX10 ○	1
	5 x TX15 ●	
	5 x TX20 ●	
	5 x TX25 ●	
	5 x TX30 ●	
	6 x TX40 ●	
	1 x Quick-change bit holder	

## Universal bit box

For universal applications



### Description

48 bits and 1 quick-change bit holder in a practical box

Art. no.	Description (Content)	PU
945858	⊕ PH 1-1-2-2-3-3	1
	⊕ PZ 1-1-2-2-3-3	
	○ Hex 4-4-5-5-6-6	
	□ Square 1-1-2-2-3-3	
	⊗ TX 10-10-15-15-20-20-25-25-27-27-30-30	
	⊗ SI-TX 10-10-15-15-20-20-25-25-27-27-30-30	
	1 x Quick-change bit holder	

## Angled screwing attachment

For hard-to-reach locations



Art. no.	PU*
499999	1

\* Comes supplied with 1 bit each for TX20, TX25 and TX30

- Head angled at 90°
- Compatible with all standard bits and machines
  - Magnetic 1/4" hexagonal bit holder
  - 1/4" hexagonal machine inputs
- Handle can be rotated and locked in 30° steps
- Suitable for clockwise and anti-clockwise rotation
- Maximum torque: 62 Nm
- Maximum speed of rotation: 2000 U/min

# Beam/slab grip with ratchet, Bracing strap tensioner

An indispensable aid for carpenters

## Beam grip

With ratchet, forged steel



### Advantages

- Drop forged hooks
- No risk of splitting while driving in
- High-quality lead screw
- 320 mm ratchet length for optimum load transmission
- Double-sided handling thanks to clockwise/counterclockwise selector

### Description

The beam/slab grip with ratchet is an indispensable aid for carpenters. Whether you want to align a roof truss or carry out other carpentry work, the beam/slab grip allows you to prestress timber quickly and easily.

Art. no.	Dimensions [mm]	Span width [mm]	PU
954054	320	Up to 600	1



## Slab grip

With ratchet

**Revised  
Version**



### Properties

- 8 attachment points per boss plate:  
→ 6 x Ø 9 mm, → 2 x Ø 13 mm
- Maximum span: 700 mm

### Advantages

- Minimal processing marks thanks to attachment using timber-construction screws
- Suitable for hard-to-reach locations (e. g. in angled areas such as roof slopes, etc.)
- Allows corner joints to be drawn together
- Suitable for timber types with an increased risk of cracking and splintering

Art. no.	Span width [mm]	PU
954037	Up to 700	1



## Bracing strap tensioner

Suitable for the beam grip with ratchet



Art. no.	Strap	PU
954055	For 1-5 mm bracing strap	1

# ScrewFiX screw-in aid

For single screws

## ScrewFiX screw-in aid

Art. no.  
800538

PU  
1



### A screw-in aid for floor and ceiling screw connections

With the ScrewFix screw-in aid, the screws are inserted using a 1-click system, meaning they do not need to be fixed manually by the tradesperson. The ScrewFix screw-in aid processes screws with a diameter measuring 5 to 6 mm and from a length of 50 mm.

#### Advantages

- Prevents injury
- Makes work easy
- Time saving – fast insertion of the screw
- Precise screw-in depth adjustment
- Easy handling

#### Main areas of application

- Packaging industry
- Timber construction
- Terrace construction
- Loft conversion
- Press bonding

#### Technical details of the FEIN drive unit

Drive unit	FEIN ASCS 6.3 Select
Idle speed	1.700 U / min-1
Screw diameter	5 to 6 mm
Bolt length	From 50 mm
Battery	18 V / 6,0 Ah Lithium-Ionen



Suitable for use with:  
Wood construction screws with counter-sunk head and a diameter of 5 – 6 mm, from a length of 50 mm



Also available with the Makita DFS452 drive unit.



#### Technical details of the Makita drive unit

Drive unit	Makita DFS452
Idle speed	4.000U / min-1
Screw diameter	5 to 6 mm
Bolt length	From 50 mm
Battery	18 V / 5,0 Ah Lithium-Ionen



# Suction lifter

## Suction lifter



### Advantages

- For an easier way of transporting bulky objects
- One-hand operation
- Flexible in use: Easy to attach and remove again

### Material

- Aluminium
- Rubber suction cup

### Product description

The Eurotec suction lifter can be put to flexible use and is suitable for lifting objects with a smooth and even surface. Bulky objects such as tiles and panes of glass can be transported without any problems. The suction cup adapts perfectly to any smooth and flat surface. The lifter creates negative pressure by turning the lever. This fixes the object securely and allows weights of up to 30 kg to be transported.

### Instructions for use

The Eurotec suction lifter is a hand tool and should not be used in combination with other lifting techniques. Before each use, be sure to check whether the rubber pad is clean and undamaged. The object to be lifted must not be made of porous material and should be free of any kind of liquids. Depending on the nature of the substrate, the suction lifter's load capacity is also adjusted. The Eurotec suction lifter is suitable for lifting sheet metal, tiles, panes of glass and plastic sheets.

**Attention** → Carry out a test before lifting a weight!

Art. no.	Dimensions [mm]	Load-bearing capacity [kg]	PU
100029	117	30	1



# Fall arrest system



## Fall arrest system

The perfect protection for working at height

Art. no.	Material	Weight [kg]	Load bearing capacity [kg]	PU
800379	Polyester, nylon	5,5	100	1



The instructions for use and warnings must be observed before using the fall protection!

### Advantages

- Karabiner: static load capacity of 25 kN
- Full body harness: in accordance with EN 353-2, the minimum load-bearing capacity is 22 kN
- No jerky deceleration due to energy absorber
- Easy to detach following use
- Guided fall arrester with fasteners (removable)

### Certifications

- Full body harness in accordance with EN 361
- Karabiner in accordance with EN 362:2004
- Rope in accordance with EN 353-2:2002
- Fall arrest device in accordance with EN 358:2001/EN 365:2005

### Description

The fall protection consists of a safety harness, a rope and a fall protection device with a connector. There is a carabiner at the end of the 1.5-metre-long rope and another one at the connector for fastening purposes. Standard-compliant equipment is particularly important, especially when working at height (on buildings, for example). It can prevent users from potentially falling from height and therefore a variety of injuries.



Delivery incl. Eurotec backpack

**NEW**  
to our product range

# Work Gloves

The ideal solution for every purpose

**SAFE  
& WORK**

## Assembly

- Excellent fit
- Breathable materials
- Safe protection
- Environment-friendly materials
- For various applications and conditions  
the right solution



### Universal

The universal gloves are flexible work gloves for industry and trade. They are ideal for dry, wet and mildly oily working environments.



### Assembly

The assembly gloves are ideal for assembly operations in dry or humid / mildly oily working environments.



### Cut Protection

The cut-resistant gloves are especially suitable for working with high protection requirements in the field of cutting resistance and puncture resistance.



### Moisture

The wet gloves are perfect for wet and highly oily working environments in which optimum grip is required.

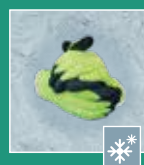

### Cold

The cold protection gloves are ideally suited for both dry and wet cold working environments.

## Attention!

Do not wear gloves while working with moving machine parts (danger of entrapment). The gloves are not impermeable to liquids and are therefore not suitable for handling chemicals.

# Work Gloves Universal



## Work Glove FlexFit

Nitrile, smooth



Art. no.	Designation	Size	Material	Coating	PU
800491	E200	7 (S)	Nylon and elastane	Nitrile, smooth	12
800492	E200	8 (M)	Nylon and elastane	Nitrile, smooth	12
800493	E200	9 (L)	Nylon and elastane	Nitrile, smooth	12
800494	E200	10 (XL)	Nylon and elastane	Nitrile, smooth	12
800495	E200	11 (XXL)	Nylon and elastane	Nitrile, smooth	12

### Specifications / Advantages

- High wearing comfort with good sensitivity
- Excellent fit
- Breathable material keeps hands cool and dry

### Application

- Gardening
- Assembly work
- Forklift and crane operation
- Carpentry, Drywall construction, Roofing
- Suitable only for work with low risks: Small impacts and vibrations

### Technical information

#### Test criteria according to EN 388:2016

Abrasion resistance	4	
Cut resistance according to conventional procedure	1	
(Further) Tear strength	3	
Puncture resistance	1	
Cut resistance according to new procedure	X	
Optional: Protection against impacts	–	

If a performance test was not performed, the missing test result is replaced by an "X".

## Work Glove FlexGrip

With Nitrile-Nubs



Art. no.	Designation	Size	Material	Coating	PU
800496	E100	7 (S)	Nylon and elastane	Nitrile-Nubs	12
800497	E100	8 (M)	Nylon and elastane	Nitrile-Nubs	12
800498	E100	9 (L)	Nylon and elastane	Nitrile-Nubs	12
800499	E100	10 (XL)	Nylon and elastane	Nitrile-Nubs	12
800500	E100	11 (XXL)	Nylon and elastane	Nitrile-Nubs	12

### Specifications / Advantages

- High wearing comfort with good sensitivity
- Excellent fit
- Breathable material keeps hands cool and dry
- Nitrile-Nubs offer improved slip protection in oily and wet conditions

### Application

- Gardening
- Assembly work
- Assembly, testing and packaging of small/sensitive parts
- Forklift and crane operation
- Carpentry, Drywall construction, Roofing
- Suitable only for work with low risks: Small impacts and vibrations

### Technical information

#### Test criteria according to EN 388:2016

Abrasion resistance	4	
Cut resistance according to conventional procedure	1	
(Further) Tear strength	3	
Puncture resistance	1	
Cut resistance according to new procedure	X	
Optional: Protection against impacts	–	

If a performance test was not performed, the missing test result is replaced by an "X".



## Work Glove

Leather



Art. no.	Designation	Size	Material	Coating	PU
800533	E1100	10 (XL)	Split cowhide leather	-	12

The rough leather provides the leather gloves with good properties against heat/cold, making them ideal for heavy work in which sensitivity plays a minor role.

### Specifications / Advantages

- Strong and high-quality split leather gloves
- High durability thanks to the rubberised cuff on the wrist

### Application

- Construction industry
- Agriculture
- Storage operations
- Suitable only for work with low risks: Small impacts and vibrations

### Technical information

#### Test criteria according to EN 388:2016

Abrasion resistance	4	<b>EN388</b>  <b>4132C</b>
Cut resistance according to conventional procedure	1	
(Further) Tear strength	3	
Puncture resistance	2	

If a performance test was not performed, the missing test result is replaced by an "X".



# Work Gloves Assembly



## Work Glove WorkFit

Nitrile, smooth



Art. no.	Designation	Size	Material	Coating	PU
800505	E400	7 (S)	Nylon and elastane	Nitrile, smooth	10
800506	E400	8 (M)	Nylon and elastane	Nitrile, smooth	10
800507	E400	9 (L)	Nylon and elastane	Nitrile, smooth	10
800508	E400	10 (XL)	Nylon and elastane	Nitrile, smooth	10

### Specifications / Advantages

- High wearing comfort with good sensitivity
- Excellent fit
- Breathable material keeps hands cool and dry
- Oil-resistant coating with good dry grip properties

### Application

- Areas of final assembly
- Assembly, testing and packaging of small / sensitive parts
- Assembly and handling of nuts, bolts and screws
- Forklift and crane operation
- Assembly and installation of electrical components
- Suitable only for work with low risks: Small impacts and vibrations

Technical information		EN388  4131X
Test criteria according to EN 388:2016		
Abrasion resistance	4	
Cut resistance according to conventional procedure	1	
(Further) Tear strength	3	
Puncture resistance	1	
Cut resistance according to new procedure	X	
Optional: Protection against impacts	-	

If a performance test was not performed, the missing test result is replaced by an "X".

## Work Glove WorkGrip

PU



Art. no.	Designation	Size	Material	Coating	PU
800501	E300	7 (S)	Polyester	PU	10
800502	E300	8 (M)	Polyester	PU	10
800503	E300	9 (L)	Polyester	PU	10
800504	E300	10 (XL)	Polyester	PU	10

### Specifications / Advantages

- Breathable back with high wearing comfort
- Excellent grip and sensitivity in dry indoor and outdoor areas

### Application

- Electrical work
- Precision assembly
- Assembly, testing and packaging of small / sensitive parts
- Suitable only for work with low risks: Small impacts and vibrations

Technical information		EN388  3121X
Test criteria according to EN 388:2016		
Abrasion resistance	3	
Cut resistance according to conventional procedure	1	
(Further) Tear strength	2	
Puncture resistance	1	
Cut resistance according to new procedure	X	
Optional: Protection against impacts	-	

If a performance test was not performed, the missing test result is replaced by an "X".



# Work Glove CutGrip

## Work Glove CutGrip

Nitrile, smooth



Art. no.	Designation	Size	Material	Coating	PU
800509	E500	7 (S)	HPPE	Nitrile, smooth	10
800510	E500	8 (M)	HPPE	Nitrile, smooth	10
800511	E500	9 (L)	HPPE	Nitrile, smooth	10
800512	E500	10 (XL)	HPPE	Nitrile, smooth	10

### Specifications / Advantages

- High wearing comfort with good sensitivity and cut-resistant inner surface
- With very good abrasion in highly oily environments
- Cutting resistance according to ISO 13997 (cut level D)

### Application

- Waste management
- Handling abrasive or sharp-edged building materials
- Handling and finishing of sheet metal
- Handling heavy metals and cutting plastics, carpets and cardboard
- Suitable only for work with low risks: Small impacts and vibrations

### Technical information

#### Test criteria according to EN 388:2016

Abrasion resistance	4	<b>EN388</b>  <b>4X44D</b>
Cut resistance according to conventional procedure	X	
(Further) Tear strength	4	
Puncture resistance	4	
Cut resistance according to new procedure	D	
Optional: Protection against impacts	–	

If a performance test was not performed, the missing test result is replaced by an "X".

## Work Glove CutGrip

Nitrile, granular



Art. no.	Designation	Size	Material	Coating	PU
800513	E600	7 (S)	HPPE	Nitrile, granular	10
800514	E600	8 (M)	HPPE	Nitrile, granular	10
800515	E600	9 (L)	HPPE	Nitrile, granular	10
800516	E600	10 (XL)	HPPE	Nitrile, granular	10

### Specifications / Advantages

- High wearing comfort with good sensitivity and cut-resistant inner surface
- With very good abrasion in highly oily environments
- Cutting resistance according to ISO 13997 (cut level D)

### Application

- Handling abrasive or sharp-edged building materials
- Handling and finishing of sheet metal
- Handling heavy metals and cutting plastics, carpets and cardboard
- Suitable only for work with low risks: Small impacts and vibrations

### Technical information

#### Test criteria according to EN 388:2016

Abrasion resistance	4	<b>EN388</b>  <b>4343D</b>
Cut resistance according to conventional procedure	3	
(Further) Tear strength	4	
Puncture resistance	3	
Cut resistance according to new procedure	D	
Optional: Protection against impacts	–	

If a performance test was not performed, the missing test result is replaced by an "X".

# Work Gloves Moisture protection



## Work Glove AquaGrip

Nitrile, granular



Art. no.	Designation	Size	Material	Coating	PU
800517	E700	7 (S)	Nylon	Nitrile, granular	10
800518	E700	8 (M)	Nylon	Nitrile, granular	10
800519	E700	9 (L)	Nylon	Nitrile, granular	10
800520	E700	10 (XL)	Nylon	Nitrile, granular	10

### Specifications / Advantages

- Breathable back of hands with high wearing comfort
- Excellent grip and sensitivity in oily working areas

### Application

- Oil industry
- Maintenance work to machines
- Motor vehicle companies
- Suitable only for work with low risks: Small impacts and vibrations

Technical information		
Test criteria according to EN 388:2016		
Abrasion resistance	4	 <b>EN388</b> <b>4131X</b>
Cut resistance according to conventional procedure	1	
(Further) Tear strength	3	
Puncture resistance	1	
Cut resistance according to new procedure	X	
Optional: Protection against impacts	-	

If a performance test was not performed, the missing test result is replaced by an "X".

## Work Glove AquaGrip Plus

Textured latex



Art. no.	Designation	Size	Material	Coating	PU
800525	E900	7 (S)	Polyester	Textured latex	10
800526	E900	8 (M)	Polyester	Textured latex	10
800527	E900	9 (L)	Polyester	Textured latex	10
800528	E900	10 (XL)	Polyester	Textured latex	10

### Specifications / Advantages

- Breathable back of hands with high wearing comfort
- Excellent grip and sensitivity in oily working areas

### Application

- General maintenance
- Waste management
- Heating and sanitation
- Suitable only for work with low risks: Small impacts and vibrations

Technical information		
Test criteria according to EN 388:2016		
Abrasion resistance	2	 <b>EN388</b> <b>2242X</b>
Cut resistance according to conventional procedure	2	
(Further) Tear strength	4	
Puncture resistance	2	
Cut resistance according to new procedure	X	
Optional: Protection against impacts	-	

If a performance test was not performed, the missing test result is replaced by an "X".





# Work Gloves Cold protection

## Work Glove IceGrip

Textured latex



Art. no.	Designation	Size	Material	Coating	PU
800529	E1000	7 (S)	Polyester	Textured latex	10
800530	E1000	8 (M)	Polyester	Textured latex	10
800531	E1000	9 (L)	Polyester	Textured latex	10
800532	E1000	10 (XL)	Polyester	Textured latex	10

### Specifications / Advantages

- Protection against cold
- Good grip and slip resistance
- Good visibility thanks to bright colour

### Application

- Waste management
- Joinery, drywall construction, roofing, carpentry and crane operation
- Construction work
- Perfect for dry work in cold environments
- Suitable only for work with low risks: Small impacts and vibrations

### Technical information

#### Test criteria according to EN 388:2016

Abrasion resistance	2	EN388	EN511
Cut resistance according to conventional procedure	1		
(Further) Tear strength	3	2132X	X1X
Puncture resistance	2		
Cut resistance according to new procedure	X		
Optional: Protection against impacts	-		

If a performance test was not performed, the missing test result is replaced by an "X".

## Work Glove IceGrip Plus

Textured latex



Art. no.	Designation	Size	Material	PU
800521	E800	7 (S)	Polyester, Inside: Terry cloth	10
800522	E800	8 (M)	Polyester, Inside: Terry cloth	10
800523	E800	9 (L)	Polyester, Inside: Terry cloth	10
800524	E800	10 (XL)	Polyester, Inside: Terry cloth	10

### Specifications / Advantages

- Two-layer winter gloves
- Protection against cold
- Good visibility thanks to bright colour
- High wearing comfort with good sensitivity

### Application

- Outdoor construction work
- Waste management
- Forestry
- Perfect for cold and wet working environments
- Suitable only for work with low risks: Small impacts and vibrations

### Technical information

#### Test criteria according to EN 388:2016

Abrasion resistance	4	EN388	EN511
Cut resistance according to conventional procedure	2		
(Further) Tear strength	2	4221X	X2X
Puncture resistance	1		
Cut resistance according to new procedure	X		
Optional: Protection against impacts	-		

If a performance test was not performed, the missing test result is replaced by an "X".

# Protective helmet (EN 397)



## Protective helmet

Perfect protection for work at a height and at ground level



Art. no.	Colour	Head circumference [cm]	Total weight [g]	PU
800397	black	51 - 62	375	1
800398	white	51 - 62	375	1
800399	pink	51 - 62	375	1

### Advantages and properties

- Optimum protection for work at a height and at ground level
- Control dial system allows adjustment to head size  
→ Adjustable head size from 51 to 62 cm
- Efficient ventilation system thanks to 10 ventilation slots
- Four-point nylon chinstrap
- Lightweight and therefore very comfortable to wear
- Certified according to EN 397



Quick and easy control dial system for a perfect fit on the head



The ventilation system provides a pleasant cooling effect



- 1 The ventilation slots provide a pleasant cooling effect
- 2 The clips allow secure attachment of a head torch
- 3 An unobtrusive slot for attachable ear defenders
- 4 The padded lining is made of comfortable nylon
- 5 Quick and easy control dial system for a perfect fit on the head

# Carpenter's hammer, Screw clamp Single-use lifting strap, Wall support

## Carpenter's hammer



Art. no.	Dimensions [mm] <sup>a)</sup>	Weight [g]	PU
800378	330	600	1

a) Total length

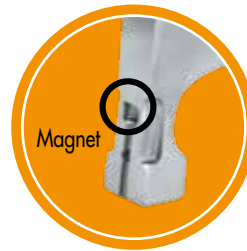

### Properties

- Equipped with magnetic nail holder
- VPA/GS-tested and -certified

## Screw clamp

An extremely robust screw clamp for professional use



Art. no.	Dimensions [mm] <sup>a)</sup>	PU
800388*	600 x 95	1
800389*	800 x 95	1
800390*	1000 x 95	1
800391*	1250 x 95	1
800392*	1500 x 95	1
800393*	2000 x 95	1

a) Span width x outreach  
\* Discontinued item

### Advantages

- Extremely sturdy sliding bar
- Ergonomic, non-slip twist handle
- Replaceable and very wide load plates
  - Gentle on the workpiece
  - Comes supplied with one replacement load plate
- High impact strength
- Clip-on bearing plates for the sliding bar
  - Guarantees level support on the workpiece and therefore also protection against points of compression

## Steel screw clamp

Universal application



Art. no.	Span [mm]	Outreach [mm]	Weight [kg]	PU
800356	6200	120	1,39	1
800357	400	120	1,75	1
800358	600	120	2,10	1
800359	800	120	2,46	1
800360	1000	120	2,81	1

### Advantages

- Sturdy adjusting bar
- Ergonomic, non-slip handle
- High impact resistance
- Fixed and sliding jaws made of malleable cast iron
- PP pads prevent the workpieces from slipping off

## Single-use lifting strap



Art. no.	Effective Working Length [cm]	Rated carrying capacity [kg]	PU
800361	40	800	1
800362	50	800	1
800363	60	800	1
800381	80	800	1
800382	100	800	1
800383	120	800	1

### Advantages





- Cost-effective transport aids
- Easy to handle and dispose of
- Low dead weight
- Easy to detach following use
- Manufactured according to DIN 60005

### Description

The single-use lifting strap is ideal for transporting goods from the production facility to the consumer. In accordance with DIN 60005, single-use lifting straps can only be used once and must be destroyed and disposed of at the end of the transport chain.

Art. no.	Effective working length/EWL	Circumference/CIRU.	WLL [kg]	Safety factor	Width [mm]	Material	Standard
800361	40	80	800	5 : 1	48	100% Polyester	DIN 60005
800362	50	100	800	5 : 1	48	100% Polyester	DIN 60005
800363	60	120	800	5 : 1	48	100% Polyester	DIN 60005
800381	80	160	800	5 : 1	48	100% Polyester	DIN 60005
800382	100	200	800	5 : 1	48	100% Polyester	DIN 60005
800383	120	240	800	5 : 1	48	100% Polyester	DIN 60005

### Load bearing capacity [kg]

Simply direct	Simply laced	Simply turned	7° - 45°	45° - 60°
800	640	1600	1120	800
				

## Wall support

Provides support during the installation of prefabricated walls, galvanised



Art. no.	Length [mm]	Angle of inclination	PU
803572	1600 - 3000	Max. 45°	1

### Adjustment range of 160–300 cm

- Basic adjustment via 13 stop positions at intervals of 10,6 cm
- Fine adjustment with an adjustment range of 19 cm

### Advantages

- Universal application
- Easy operation
- Fast assembly
- Almost no force needed from the user
- Very secure and sturdy
- Saves time

### Makes the assembly of prefabricated walls significantly easier

Thanks to their high load-bearing capacity, the Eurotec wall supports can support walls until they are fully assembled without any problems and therefore take the place of many helping hands. A locking pin system allows especially quick and easy adjustment of the wall support's height. Subsequent fine adjustment is also possible using threaded rods.



**NEW**  
to our product range

## Round slings

For lifting fragile loads



### Advantages / Properties

---

- According to EN 1492-2
- Double-woven tubular sheath made of polyester fabric, core made of polyester yarn
- High load-bearing capacity
- Low dead weight
- Wide bearing surface
- Colour coding to EU standard
- Barrel stripes sewn in
- Bearing capacity (WLL - Working Load Limit) printed on

### Round sling

Bearing capacity 1000 kg



Art. no.	Dimensions	Scope [m]	Load-bearing capacity [kg]	PU
324040	1 m x 5 mm	2	1000	1
324070	1,5 m x 50 mm	3	1000	1

### Round sling

Bearing capacity 2000 kg



Art. no.	Dimensions	Scope [m]	Load-bearing capacity [kg]	PU
324060	1 m x 55 mm	2	2000	1
324080	1,5 m x 55 mm	3	2000	1
324050	2 m x 55 mm	4	2000	1

### Round sling

Bearing capacity 3000 kg



Art. no.	Dimensions	Scope [m]	Load-bearing capacity [kg]	PU
324100	2 m x 65 mm	4	3000	1



**NEW**  
to our product range

# Lashing strap



## Advantages / Properties

- In accordance with EN 12195-2
- One-piece or two-piece
- High tear resistance
- Load-bearing capacities from 125 to 2500 kg

## Lashing strap

With ratchet and claw hook



Art. no.	Dimensions	Load capacity [kg] *	Material	PU
323680	5 m x 25 mm	500	Poliester	1
323690	6 m x 35 mm	1000	Poliester	1
323770	6 m x 35 mm	1500	Poliester	1
323960	8 m x 50 mm	2000	Poliester	1
323970	12 m x 50 mm	2000	Poliester	1

\* Max. permitted tensile force for tension in a straight line, see load capacity; for wrap-around tension, load capacity is doubled.

### Properties/Advantages

- Two-piece
- PES belt
- Belt end with claw hook
- According to EN 12195-2

## Lashing strap

With Ergo ratchet and claw hook



Art. no.	Dimensions	Load capacity [kg] *	Material	PU
323830	8 m x 50 mm	2000	Poliester	1

\* Max. permitted tensile force for tension in a straight line, see load capacity; for wrap-around tension, load capacity is doubled.

### Properties / Advantages

- Two-piece
- PES belt
- Belt end with claw hook
- According to EN 12195-2

## Lashing strap

With ratchet and claw hook, 8 m x 50 mm



Art. no.	Dimensions	Load capacity [kg]	Material	PU
323980	8 m x 50 mm	2500	Poliester	1

### Properties / Advantages

- Two-piece
- PES belt
- Belt end with claw hook
- Max. permitted tensile force for tension in a straight line 2500 daN, for wrap-around tension 5000 daN
- According to EN 12195-2

## Lashing strap

With S-hook



Art. no.	Dimensions	Load capacity [kg]	Material	PU
323950	5 m x 25 mm	500	Poliester	1

### Properties / Advantages

- Two-piece
- PES belt
- Belt end with claw hook
- Max. permitted tensile force for tension in a straight line 500 daN, for wrap-around tension 1000 daN
- According to EN 12195-2



## Lashing strap

With ratchet 5 m x 25 mm

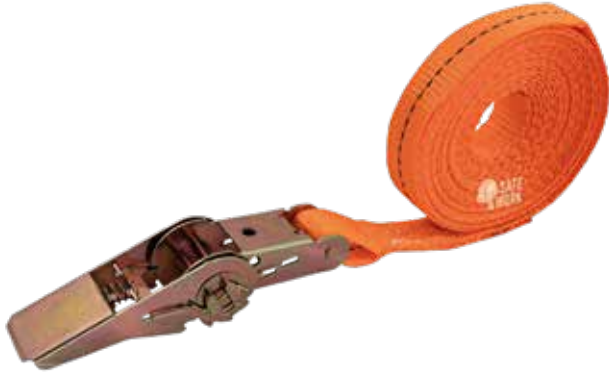

Art. no.	Dimensions	Load capacity [kg]	Material	PU
323710	5 m x 25 mm	500	Poliester	1

### Properties / Advantages

- One-piece
- PES belt
- Max. permitted tensile force for tension in a straight line 500 daN, for wrap-around tension 1000 daN
- According to EN 12195-2

## Lashing strap

With ratchet 6 m x 35 mm



Art. no.	Dimensions	Load capacity [kg]	Material	PU
323860	6 m x 35 mm	1000	Poliester	1

### Properties / Advantages

- One-piece
- PES belt
- Max. permitted tensile force for tension in a straight line 1000 daN, for wrap-around tension 2000 daN
- According to EN 12195-2

## Lashing strap

With ratchet 8 m x 50 mm



Art. no.	Dimensions	Load capacity [kg]	Material	PU
323870	8 m x 50 mm	2000	Polyester	1

### Properties / Advantages

- One-piece
- PES belt
- Max. permitted tensile force for tension in a straight line 2000 daN, for wrap-around tension 4000 daN
- According to EN 12195-2

## Lashing strap

With ratchet 5 m x 25 mm



Art. no.	Dimensions	Load capacity [kg]	Material	PU
323850	5 m x 25 mm	250	Poliester	1

### Properties / Advantages

- One-piece
- PES belt
- Max. permitted tensile force for tension in a straight line 250 daN, for wrap-around tension 500 daN
- According to EN 12195-2

## Lashing strap

With clamping lock



Art. no.	Dimensions	Load capacity [kg]	Material	Contents	PU
323820	2,5 m x 25 mm	125	Poliester	2	1
323990	4 m x 25 mm	125	Poliester	2	1

### Properties / Advantages

- One-piece
- PES belt
- Max. permitted tensile force for tension in a straight line 125 daN, for wrap-around tension 250 daN
- According to EN 12195-2

## Lashing strap

With belt clamp



Art. no.	Dimensions	Load capacity [kg]	Material	PU
323800	3 m x 25 mm	250	Poliester	1
323810	5 m x 25 mm	250	Poliester	1

### Properties / Advantages

- One-piece
- PES belt
- Max. permitted tensile force for tension in a straight line 250 daN, for wrap-around tension 500 daN
- According to EN 12195-2

# Transport anchor system

Transport anchor and transport anchor screws

## Transport anchor

High-quality steel



### Please note

- Transport anchor screws must only be used once
- Insert the screws without pilot-drilling
- Read the operating instructions in detail before use
- Users are to be trained before beginning use for the first time
- The transport anchor is to be examined for damage before each use and rejected if necessary
- The weight of the component to be lifted must not exceed the permissible value
- At least two attachment points per component to be lifted

### The secure lifting system

Made of high-grade steel, this lifting attachment is used to lift all kinds of timber parts safely and easily. The transport anchors of the load group up to 1,3 tonnes are strictly to be used only in conjunction with the Ø 11 x 125 mm and Ø 11 x 160 mm Eurotec transport anchor screws. The Eurotec transport anchor screws must only be used once. They are to be screwed into solid wood (softwood), laminated veneer timber, glued laminated timber, cross laminated timber, stacked planks and laminated joists without pilot-drilling. Use in hardwoods is not permitted. The possible, or rather permissible, assembly positions can be found in our operating instructions, of which we will be delighted to provide you with a copy.

Art. no.	Dimensions [mm] <sup>a)</sup>	Load group	PU*
110361	190 x 70	Up to 1,3 tons	2

a) Length x width

\* Screws must be ordered separately (see below)

### Permissible lifting load<sup>a)</sup> per attachment point<sup>b)</sup>

	$\gamma^d$	$\alpha^b$	11 x 125 mm	11 x 160 mm
Axial tension	60°	60°	533 kg	603 kg
	60°	30°	409 kg	462 kg
Diagonal tension	60°	90°	462 kg	522 kg
	60°	0°	139 kg	157 kg

a) Calculation according to ETA-11/0024 with wood density  $\rho_k = 350 \text{ kg/m}^3$ ;  $k_{mod} = 0,9$ ;  $\gamma_M = 1,3$ ;  $\gamma_R = 1,35$ ;  $g = 9,81 \text{ m/s}^2$  and dynamic factor  $\phi_2 = 1,16$ .

All mechanical values provided should be viewed as subject to the assumptions that have been made and represent example calculations. All values are calculated minimum values and are subject to typographical and printing errors.

b) At least two lines must be used per component to be lifted. Each line leads to exactly one attachment point. If more than two lines are attached, only two attachment points can be assumed to be load-bearing unless it is ensured that the load is distributed evenly onto further lines (e.g. using a compensator) or that the uneven load distribution does not exceed the permissible loading of the individual lines.

c)  $\gamma$  - Inclination angle of line (chain, rope, lifting strap etc.); at least 60° according to BGR 500

d)  $\alpha$  - Angle between grain direction and screwing axis

Please note: These are planning aids. Projects must only be calculated by authorised persons.

## Transport anchor screw

High-quality steel, with AG tip, specially coated



Art. no.	Dimensions [mm]	Head	PU
110359	11 x 125	SW17	20
110360	11 x 160	SW17	20

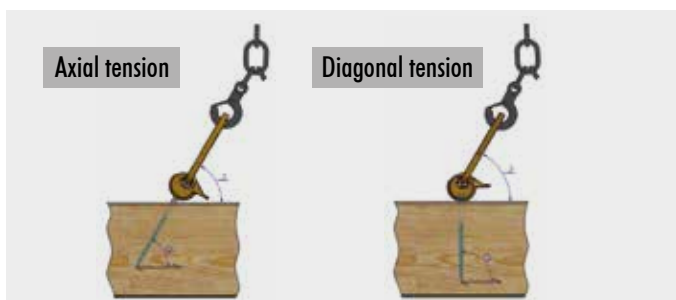

# Cutter, Folding cutter/-set

Tools for every craftsman's toolbox

## Cutter

Art. no.	Description	PU
800387	With eight snap-off blades	1



### Description

- Removable blade magazine with eight snap-off blades
- Automatic blade feed and locking
- Ergonomic non-slip handle

## Folding cutter

Art. no.	Description	PU
800411	Incl. 5 replacement blades each	6

Supplied with presentation display



## Folding cutter set

Art. no.	Description	PU
800408	Incl. 5 replacement blades and 1 knife pouch each	6

Supplied with presentation display



### Advantages

- Effective blade length 40% greater than with standard cutters
- Quick-change mechanism
- Thumb rest
- Secure blade locking and unlocking
- Stainless steel housing
- Blade can be locked in 4 positions
- Non-slip grip
- Compatible with standard blades



# Japanese saw, Multitool

## Japanese saw

Collapsible



### Application areas

- Carpentry crafts, tree care, pruning of trees etc.

### Advantages

- Easy handling, fine cuts and flexible saw blade
- Low force exertion and material wear
- Saves time

### Please note

- The cutting surfaces are very sharp
- Practise handling before first use to avoid injuries

Art. no.	Length of saw blade [mm] <sup>a)</sup>	Dimensions [mm] <sup>b)</sup>	Material thickness [mm]	PU
800400	240 x 35 x 1	530/200	1	1

a) Length x width x strength  
b) Total length/handle length

## Ersatzsägeblatt

Für Japansäge



Art.-Nr.	Abmessung [mm] <sup>a)</sup>	Materialstärke [mm]	VPE
800401	240 x 35	1	1

a) Länge x Breite

## Multitool



Art. no.	Material	Dimensions [mm] <sup>a)</sup>	Number of individual implements	PU
800482	Stainless steel	105 x 50 x 20	10	1

a) Height x length x width

### Advantages

- Combines ten individual implements in a single tool
- Incl. bag and bits
- A practical product for when you're out and about

### Attention

- There is a risk of crushing when folding in the individual implements. Please ensure you don't crush your fingers and hands.
- Keep out of the reach of children!

## Fuctions

- |                       |                        |
|-----------------------|------------------------|
| 1 Ruler + File        | 6 Bottle opener        |
| 2 Slotted screwdriver | 7 Phillips screwdriver |
| 3 Bit holder          | 8 Saw                  |
| 4 Knife               | 9 Wire cutter          |
| 5 Saw knife           | 10 Needle-nose pliers  |

# Insulation knife, Ripsaw

## Insulation knife

Stainless steel blade



- Total length: 480 mm
- Blade length: 340 mm
- Blade width: 50 mm
- Material: blade made of stainless steel, handle made of plastic

Art. no.	Name	Blade [mm]	PU
800410	Insulation knife	340 x 50	1

## Insulation knife, double-sided

Stainless steel blade



Art. no.	Total length [mm]	Blade [mm]	PU
800409	550	420 x 50	1

## Ripsaw

Universal saw



### Advantages

- Fine cuts, low force exertion
- Time saving due to high cutting speed
- Comfortable handle with non-slip rubber inlay
- Extra posthardening on toothing; less wear
- Handle with 45° and 90° guides for use as an angle template

### Please note

- The cutting surfaces are very sharp
- Practise handling before first use to avoid injuries

Art. no.	Name	Length [mm]	PU
800405	Ripsaw universal saw	500	1



# Laser Rangefinder 50M

## Laser Rangefinder 50M

Art. no.	Dimensions [mm]	Weight	PU
800469	119 x 49,5 x 22	68 g	1



### Advantages

- Precise and reliable laser technology - 50 meter range
- Simple measurement of distances, areas and volumes
- Includes belt pouch and batteries
- Stores the last 10 measurements

### Description

The Eurotec Laser Measure 50M enables the quick and easy measurement of distances as well as areas and volumes. It is suitable for general as well as professional use. Measured values can be added and subtracted. The memory function also allows access to the last 10 measurements made. With its robust housing and IP54 dust and splash protection, the laser measure is ideal for daily use on the construction site.

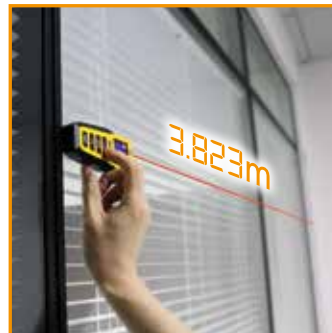

# Cross-line laser, Combi Laser

Precise alignment due to innovative laser technology

## Cross-line Laser



### Advantages

- Delivers precise lines with an accuracy of  $\pm 0,3$  mm at 10 m
- Self-leveling range of  $\pm 4^\circ$
- It projects a perfect green laser cross for simple and precise alignment of objects on the wall
- For simple and precise alignment of objects
- Splashwater and dust protected according to IP54

### Description

With the Eurotec Cross-line Laser, the tedious alignment with a spirit level is a thing of the past. The device enables a wide variety of objects to be easily aligned. Because of the green laser technology the laser lines of the Cross-line Laser are up to four times more perceptible to the human eye than red laser lines. The improved visibility of the Eurotec Cross-line Laser with green lasers enables, compared to devices with red laser lines, more uses and an extension of the work area up to 30 m.

Art. no.	Dimensions [mm] <sup>a)</sup>	Accessories	PU
800485	75,8 x 75,5 x 65,4	User manual, Soft bag	1

a) Height x length x width



Example of application: Cross-line Laser

## Combi Laser



### Advantages

- Delivers precise lines with an accuracy of  $\pm 0,2$  mm at 15 m
- Self-leveling range of  $\pm 4^\circ$
- Combination of green cross line and five point laser
- For demanding tasks, e.g. in dry construction and interior finishing
- Splashwater and dust protected according to IP54

### Description

The Eurotec Combi Laser is suitable for a variety of demanding tasks, for example in drywall and interior construction. The combination of cross line and five-point laser enables the device to be aligned precisely in the room as it operates with an accuracy of  $\pm 0,2$  mm at 15 m, therefore it meets all requirements for professional users. Thanks to the laser plumb lines, vertical and vertical alignment are no longer a problem. The laser levels itself in a range of  $\pm 4^\circ$  in less than 4 seconds.

Art. no.	Dimensions [mm] <sup>a)</sup>	Accessories	PU
800486	108,3 x 120 x 76	User manual, Soft bag	1

a) Height x length x width



Example of application: Combi Laser



# Measuring tools

For work around the home and for professional use

## Pocket tape measure

With magnet



### Advantages

- Meets EC accuracy class I
- Automatic locking of measuring tape
- Push-button retraction
- Powerful magnet on end hook
- Belt clip on rear side
- Nylon coating on both sides of measuring tape
- Tape buffered by limit stop when retracted
- Robust, impact-resistant plastic housing with partial rubber coating

### Properties

- Maximum extension before 5 m tape kinks (horizontal): 2,00 m
- Maximum extension before 5 m tape kinks (vertical): 3,10 m
- Metric scale

Art. no.	Dimensions [mm]	PU
800461	5000 x 22	1

## Tape measure

Steel



### Advantages

- Meets EC accuracy class II
- Retraction gear with hand crank
- Fast gear ratio of 3:1
- Nylon coating on both sides of measuring tape
- Fold-out end hook on pull ring
- Measurements begin at front edge of fitting
- Robust, impact-resistant plastic housing with partial rubber coating

Art. no.	Dimensions [mm]	PU
800464	3000 x 13	1

## Deep hole marker

Lace: Stainless steel, Pen: ABS plastic

**NEW**  
to our product range



### Advantages

- The pen features a high-quality metal tip, which is retractable
- Marking is possible on the following surfaces:  
→ wood, metal, concrete, ceramics, plastics and many more.
- Integrated sharpener in the pencil cap
- The clip included ensures that a separate pen holder isn't required

### Description

The Eurotec Deep Hole Marker Set makes it possible to mark areas that are particularly hard to access. The high-quality graphite leads are ideal for marking materials such as plastic, wood and steel. A refill box containing 6 replacement graphite leads is included in delivery. The pen features a high-quality metal tip, which is retractable.

Art. no.	Dimensions [mm] <sup>a)</sup>	Material	PU
800540	40,4 x 17,5 x 140,7	Lace: Stainless steel Pen: ABS plastic	1

a) Height x width x length



Contains 6 more  
graphite leads

## Chalk line set

With chalk



Art. no.	Length [m]	Contents [g]	PU
800462	30	200	1

### Advantages

- Retraction gear with hand crank – also lockable
- Fast gear ratio of 3:1
- Robust, impact-resistant plastic housing with partial rubber coating
- Durable stainless steel hook
- Easy stowage of end hook on housing
- Sliding compartment for easy filling
- Includes 200 g of waterproof blue chalk
- Resealable chalk container

## Blue chalk



**Suitable for this**

Art. no.	Contents [g]	PU
800463	200	1

## Magnetic spirit level



Art. no.	Dimensions [mm] <sup>a)</sup>	PU
800394	50 x 600 x 20 mm	1
800395	50 x 1000 x 20 mm	1
800396	50 x 1800 x 20 mm	1

a) Height x length x width

### Advantages

- Extremely high measuring accuracy of 0,5 mm/m
- Extremely high sensitivity of 0,25 mm/m
- Low deviation of just 0,15 mm/m
- Can measure horizontal and vertical planes as well as 45° angles
- Magnets prevent slippage on metallic surfaces
- Easy cleaning thanks to high-quality powder coating
- High durability and long service life

### Properties

- Material: aluminium
- Colour: yellow/black
- Three bubble levels – horizontal/vertical/45° angles
- Level blocks: transparent acrylic glass, mounted using epoxy adhesive
- Concealed magnets on the underside

# Ratchets, Hammer tacker

## Universal-Multi-Ratchet

With 8 opening sizes



Art. no.	Spanner gap	PU
800385	10 - 13 - 14 - 17 - 19 - 22 - 24 - 27	1

## Scaffold ratchet



### Advantages

- Made of high-quality chromium/vanadium steel
- Double socket with multiple stages of annealing
- Switch for clockwise or anticlockwise rotation
- Long service life
- Suitable for a wide range of applications
- Easy operation
- Allows flexible working

Art. no.	Spanner gap	PU
800386	19 - 22	2

## Hammer tacker



- Ergonomic soft-touch handle
- Easy reloading of the magazine
- Capacity of up to 168 brackets
- Delivers maximum impact force

Art. no.	Dimensions [cm]	Weight [g]	PU
800376	31 x 3,7 x 7,2	912	1



## Hammer tacker brackets

**Suitable for this**

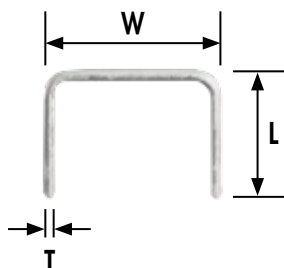

Art. no.	Length [L/mm]	Width [W/mm]	Thickness [T/mm]	PU*
800371	6	10,6	1,25	1
800372	8	10,6	1,25	1
800373	10	10,6	1,25	1
800374	12	10,6	1,25	1

\* 1 PU = 5000 Hammer tacker brackets

# Auger bit

## Auger bit



### Advantages

- Precise positioning ensured thanks to spiral-shaped tip
- Specially shaped transport screw
  - Virtually no expenditure of force required
  - Allows a fast rate of drilling
  - High removal rate
  - Suitable for especially deep drill holes
- Centre point with integrated feed screw
  - Prevents drill from slipping
  - Feeds into material independently, thereby reducing the effort required
  - Low speeds possible
- Pre-cutter on drill point
  - No chipping around drill hole
  - Draws itself into the workpiece quickly and without causing splintering
  - No need for finishing work on the cutting edge
- A hexagonal shaft ensures that the drill is gripped securely in the chuck
- Ideal for through holes and pilot-drilling

Art. no.	Dimensions [mm] <sup>a)</sup>	Art. no.	PU
800412	6 x 235		1
800413	6 x 320		1
800414	6 x 460		1
800415	8,0 x 235		1
800425	8,0 x 320		1
800435	8,0 x 460		1
800416	10,0 x 235		1
800426	10,0 x 320		1
800436	10,0 x 460		1
800417	12,0 x 235		1
800427	12,0 x 320		1
800437	12,0 x 460		1
800428	14,0 x 320		1
800438	14,0 x 460		1
800429	16,0 x 320		1
800439	16,0 x 460		1
800449	16,0 x 650		1
800430	18,0 x 320		1
800440	18,0 x 460		1
800450	18,0 x 650		1
800431	20,0 x 320		1
800441	20,0 x 460		1
800451	20,0 x 650		1
800432	22,0 x 320		1
800442	22,0 x 460		1
800452	22,0 x 650		1

a) Ø x Length

## Auger bit set



Art. no.	Dimension/bit [mm]	Art. no.	PU
800455	8,0 x 320 - 10 x 320 - 12 x 320 - 14 x 320 16 x 320 - 18 x 320 - 20 x 320 - 22 x 320		1



# Assembly wedges, Adjustment blocks

## Assembly block

With slit



- Firm grip thanks to special profiled surface
- Slit allows it to be slid onto nails and screws
- Serration inside the slit prevents it from slipping off the nail or screw

Art. no.	Dimensions [mm] <sup>a)</sup>	Load-bearing capacity [kg]	Height adjustment [mm]	Colour	PU
964550	10 x 70 x 35	≤ 200	10 - 15	Yellow	1000
964551	10 x 77 x 38	≤ 200	10 - 15	White	1000
964552	15 x 88 x 43	≤ 300	15 - 22	Grey	500
964553	25 x 140 x 43	≤ 500	25 - 42	Black	364

a) Height x length x width

## Assembly block

Closed



- Firm grip thanks to special profiled surface

Art. no.	Dimensions [mm] <sup>a)</sup>	Load-bearing capacity [kg]	Height adjustment [mm]	Colour	PU
964546	8 x 65 x 28	≤ 200	8 - 12	Red	1000
964547	15 x 88 x 43	≤ 500	15 - 22	Grey	550
964548	25 x 140 x 43	≤ 800	25 - 42	Black	364
964549*	25 x 140 x 43	≤ 2000	25 - 42	Blue	364

a) Height x length x width

\* Discontinued item

## Adjustment block

With slit



- Slit allows it to be slid onto nails and screws
- The adjustment blocks can be connected to one another as required
- Serration inside the slit prevents it from slipping off the nail or screw

Art. no.	Dimensions [mm] <sup>a)</sup>	Load-bearing capacity [kg]	Colour	PU
964561	1 x 80 x 50	≤ 200	Blue*	1000
964562	2 x 80 x 50	≤ 200	White*	1000
964563	3 x 80 x 50	≤ 200	Red*	1000
964564	4 x 80 x 50	≤ 200	Black*	1000
964565	5 x 80 x 50	≤ 200	Green*	1000
964566	10 x 80 x 50	≤ 200	Yellow*	500

a) Height x length x width

\* The previous colour is delivered until the complete changeover

## Adjustment block



- High compressive strength  
→ Load-bearing capacity of 2 tons
- When the blocks are stacked, peg and hole connections prevent them from sliding across one another sideways
- Pegs disappear under loading

Art. no.	Dimensions [mm] <sup>a)</sup>	Load-bearing capacity [kg]	Colour	PU
964554	2 x 80 x 50	≤ 2000	Red	500
964555	3 x 80 x 50	≤ 2000	Green	500
964556	5 x 80 x 50	≤ 2000	Blue	500
964557	7 x 80 x 50	≤ 2000	Brown	500
964558	10 x 80 x 50	≤ 2000	Black	500
964559	15 x 80 x 50	≤ 2000	Yellow	250
964560	20 x 80 x 50	≤ 2000	Grey	250

a) Height x length x width

## Mini adjustment block

With slit



- Slit allows it to be slid onto nails and screws
- Serration inside the slit prevents it from slipping off the nail or screw

Art. no.	Dimensions [mm] <sup>a)</sup>	Load-bearing capacity [kg]	Colour	PU
964567	1 x 50 x 38	≤ 200	Blue*	500
964568	2 x 50 x 38	≤ 200	White*	500
964569	3 x 50 x 38	≤ 200	Red*	500
964570	4 x 50 x 38	≤ 200	Black*	500
964571	5 x 50 x 38	≤ 200	Green*	500
964572	10 x 50 x 38	≤ 200	Yellow*	500

a) Height x length x width

\* The previous colour is delivered until the complete changeover

### Mixed box, assembly wedges

With and without slit



Art. no.	Contents (240 Pcs.)	VPE
964575	80 Pcs. 964546   60 Pcs. 964550   50 Pcs. 964551   40 Pcs. 964547   10 Pcs. 964548	1 Box

### Mixed box, assembly wedges

With slit



Art. no.	Contents (100 Pcs.)	PU
964573	50 Pcs. each 964553, 964552	1 Box

### Mixed box, adjustment blocks

With slit



Art. no.	Contents (250 Pcs.)	PU
964576	45 Pcs. each 964561, 964562, 964563, 964564, 964565   25 Pcs. 964566	1 Box

### Mixed box, adjustment blocks



Art. no.	Contents (140 Pcs.)	PU
964574	50 Pcs. 964554   25 Pcs. each 964555, 964556, 964558   15 Pcs. 964560	1 Box

### Mixed box, mini adjustment blocks

With slit



Art. no.	Contents (450 Pcs.)	PU
964577	100 Pcs. each 964567, 964568, 964569, 964570   25 Pcs. each 964571, 964572	1 Box

### Mixed box, adjustment blocks 120mm



Art. no.	Contents (90 Pcs.)	PU
964682	30 Pcs. 964578   25 Pcs. 964579   20 Pcs. 964580   10 Pcs. 964581   5 Pcs. 964582	1 Box



## Adjustment block L

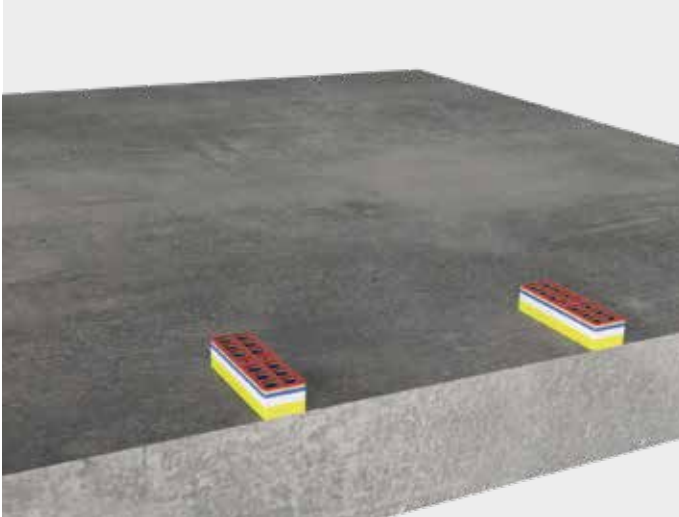

Art. no.	Dimensions [mm] <sup>a)</sup>	Load-bearing capacity [kg]	Colour	PU
964578	2 x 120 x 50	≤ 3000	Red	250
964579	3 x 120 x 50	≤ 3000	Green	250
964580	5 x 120 x 50	≤ 3000	Blue	250
964581	10 x 120 x 50	≤ 3000	Black*	100
964582	15 x 120 x 50	≤ 3000	Yellow	100

a) Height x length x width

\* The previous colour is delivered until the complete changeover

## Adjustment block XL



- Suitable for adjusting the height of stud frames  
→ Constructive timber protection when used in lining timber stud frames
- High compressive strength  
→ Load-bearing capacity of 4 tons
- Two screw holes for fixing in place with screws
- When the blocks are stacked, peg and hole connections prevent them from sliding across  
→ Pegs disappear under loading



Art. no.	Dimensions [mm] <sup>a)</sup>	Load-bearing capacity [kg]	Colour	PU
964583	2 x 160 x 50	≤ 4000	Red	250
964584	3 x 160 x 50	≤ 4000	Green	250
964585	5 x 160 x 50	≤ 4000	Blue	250
964586	10 x 160 x 50	≤ 4000	Black*	100
964587	15 x 160 x 50	≤ 4000	Yellow	100

a) Height x length x width

\* The previous colour is delivered until the complete changeover







## Concrete and masonry anchors

Rock concrete screws	388 - 392
Bolt anchor	393 - 394
Porous concrete screw 1000	395
EMD Multi plug	395
Injection mortar	396 - 401
Frame fixing	402 - 403
Rigid foam plug	404
Gypsum board plug	404
Insulating stud anchor	405
Nail plug	405 - 406
Express nail	406
Sealing plug	407
Impact rivets	407
Ceiling anchor	408
Concrete frame screw	409 - 410
Mounting disc	410
Timber frame screw	411
Level Max	411

# Rock concrete screws

For fastening to concrete without plugs



## What can they be used for?

- Anchoring in concrete (C20/25 to C50/60 normal concrete)

## Properties

- As it is screwed in, the thread cuts a mating thread into the subsurface
- High-strength screw steel
- Extremely complex annealing process
- Special thread

## Advantages

- Installation without plugs
- High extraction-resistance values
- No expansion effect, so smaller edge and centre distances are possible
- Broad range of applications thanks to a variety of screw heads and diameters
- An economical fastener
  - Time savings during installation
  - Cost savings in materials
- Time-saving and straightforward installation
  - Setting and installation process performed in a single step

## Notes

- Drill hole produced only by hammer drilling
- Setting parameters must be adhered to strictly
- Application only in C20/25 to C50/60 normal concrete

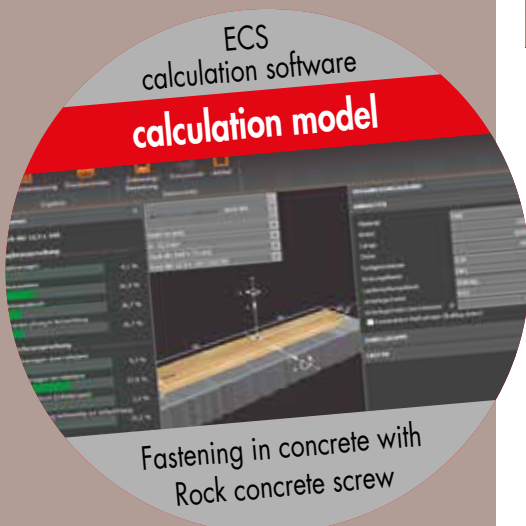
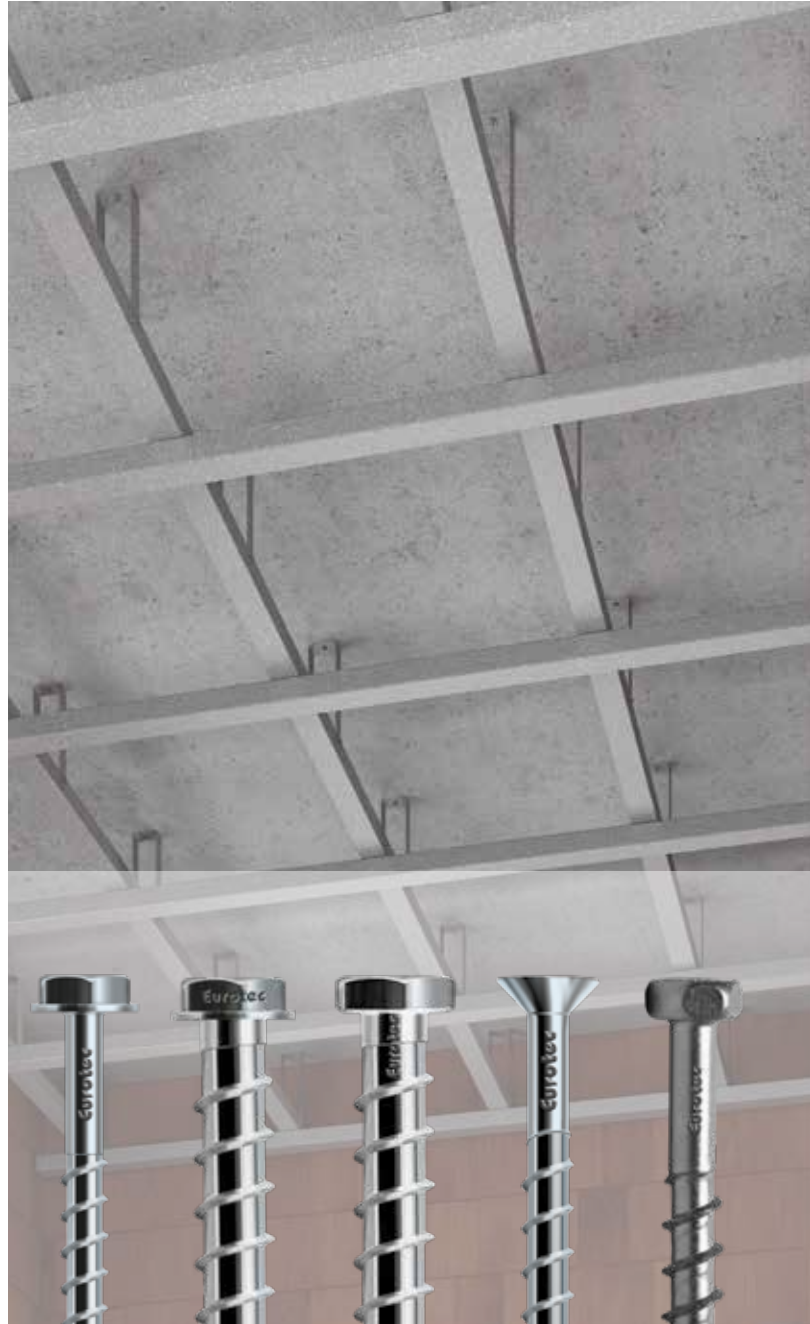

Hexagonal with flange, galvanised steel

Hexagonal with flange, special coated

Hexagonal, galvanised steel

Countersunk head, galvanised steel

Hexagonal, Bi-Metall A2

### Rock concrete screw

Hexagonal with flange, galvanised steel



Art. no.	Dimensions [mm]	Head	PU
110227*	7,5 x 40	SW13	100
110228*	7,5 x 50	SW13	100
110229	7,5 x 60	SW13	100
110230	7,5 x 80	SW13	100
110231	7,5 x 100	SW13	100
110232*	10,5 x 50	SW15	100
110233*	10,5 x 60	SW15	100
110234	10,5 x 80	SW15	100
110235	10,5 x 100	SW15	100
110236	10,5 x 120	SW15	100
110237	10,5 x 140	SW15	100
110238	10,5 x 160	SW15	100

\* Screws not regulated by ETA-15/0886

### Rock concrete screw

Hexagonal with flange, special coated



Art. no.	Dimensions [mm]	Head	PU
110253	16,5 x 115	SW18	25
110254	16,5 x 135	SW18	25
110255	16,5 x 160	SW18	25

### Rock concrete screw

Hexagonal, galvanised steel



Art. no.	Dimensions [mm]	Drive	PU
110338*	7,5 x 40	SW13	100
110339*	7,5 x 50	SW13	100
110340	7,5 x 60	SW13	100
110341	7,5 x 80	SW13	100
110342*	10,5 x 60	SW15	100
110343	10,5 x 80	SW15	100
110344	10,5 x 100	SW15	100
110345	10,5 x 120	SW15	100
110346	10,5 x 140	SW15	100
110347	10,5 x 160	SW15	100
110336*	12,5 x 60	SW17	100
110337	12,5 x 80	SW17	100
110327	12,5 x 100	SW17	100
110328	12,5 x 120	SW17	100
110329	12,5 x 140	SW17	100
110330	12,5 x 160	SW17	50
110331	12,5 x 180	SW17	50
110332	12,5 x 200	SW17	50
110333	12,5 x 240	SW17	50
110334	12,5 x 280	SW17	50
110335	12,5 x 320	SW17	50

\* Screws not regulated by ETA-15/0886

### Rock concrete screw

Countersunk head, galvanised steel



Art. no.	Dimensions [mm]	Drive	PU
110348*	7,5 x 40	TX40 ●	100
110349	7,5 x 60	TX40 ●	100
110350	7,5 x 80	TX40 ●	100
110351	7,5 x 100	TX40 ●	100
110352	7,5 x 120	TX40 ●	100
110353	7,5 x 140	TX40 ●	100
110354	7,5 x 160	TX40 ●	100

\* Screws not regulated by ETA-15/0886

**Rock concrete screw**

Hexagonal, Bi-Metall A2

Art. no.	Dimensions [mm]	Drive	PU
110355	10,5 x 95	SW15	8



Suitable for  
PediX and Robusto

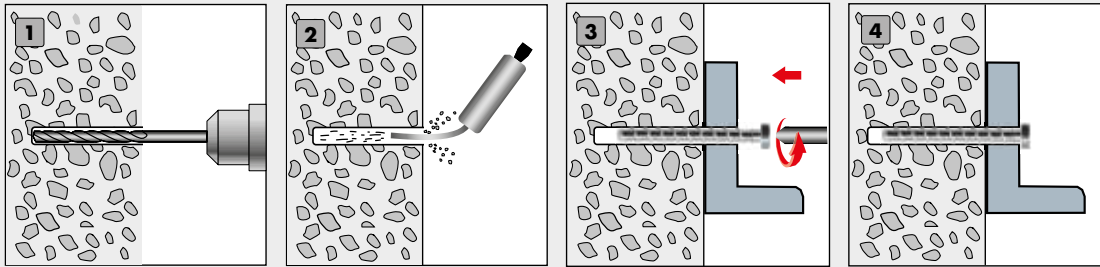

**Application**

- 1 Create drill hole (hammer drill)
- 2 Clean drill hole
- 3 Mount attachment
- 4 Done!





# Technical information Rock concrete screw

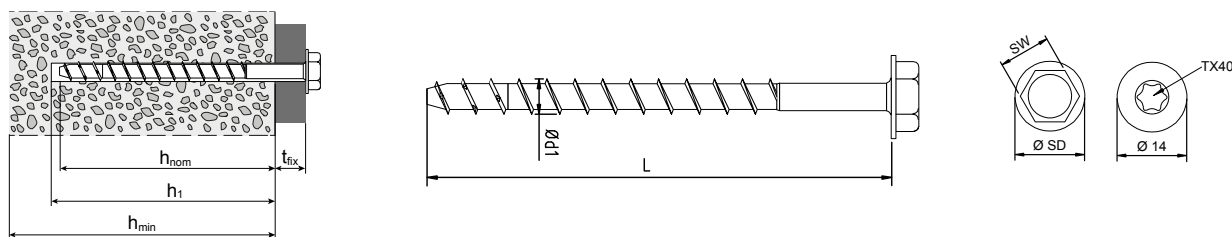

Dimension Ø x Length Ød1 x L [mm]	Ø Head WAF/dk [mm]	Ø Flange SD [mm]	Minimum part thickness h <sub>min</sub> [mm]	Attachment thickness t <sub>fix</sub> [mm]	Screwing depth h <sub>nom</sub> [mm]	Characteristic values of load-bearing capacity for tensile or shear loading <sup>a)</sup>				Drill diameter (Concrete) d <sub>0</sub> [mm]	Depth of drill hole h <sub>1</sub> [mm]	Diameter of drill hole (attachment) d <sub>f</sub> [mm]	min. Edge/ centre distance S <sub>min</sub> /C <sub>min</sub> [mm]
						Tensile load-bearing capacity (non-cracked concrete, C20/25) N <sub>Rk,p</sub> [kN]	Tensile load-bearing capacity (cracked concrete, C20/25) N <sub>Rk,p</sub> [kN]	Shear load-bearing capacity (Steel) V <sub>Rk,s</sub> <sup>b)</sup> [kN]	Bending moment (Steel) M <sub>Rk,s</sub> <sup>b)</sup> [Nm]				

### Rock, hexagonal with flange

7,5 x 60	SW13	16,5	100	5	55	6,0	3,0	11,0	19,0	6	70	9	40
7,5 x 80				25									
10,5 x 80				5									
10,5 x 100	SW15	17,5	160	25	75	6,0	3,0	22,0	51,0	9	90	12	55
10,5 x 120				45									
10,5 x 140				65									
10,5 x 160				85									
16,5 x 115	SW18	30,5	175	5	110	40,0	30,0	57,9	235,9	14	130	18	100
16,5 x 135				25									
16,5 x 160				50									

### Rock, hexagonal

7,5 x 60	SW13	n/a	100	5	55	6,0	3,0	11,0	19,0	6	70	9	40
7,5 x 80				25									
10,5 x 80				5									
10,5 x 100	SW15	n/a	160	25	75	6,0	3,0	22,0	51,0	9	90	12	55
10,5 x 120				45									
10,5 x 140				65									
10,5 x 160				85									
12,5 x 80	SW17	n/a	200	5	75	25,0	12,0	35,0	98,0	10	90	14	65
12,5 x 100	SW17	n/a	200	5	95	25,0	12,0	35,0	98,0	10	110	14	65
12,5 x 120				25									
12,5 x 140				45									
12,5 x 160				65									
12,5 x 180				85									
12,5 x 200				105									
12,5 x 240				145									
12,5 x 280				185									
12,5 x 320	225												

### Rock, countersunk head

7,5 x 60	14,0	n/a	100	5	55	6,0	3,0	11,0	19,0	6	70	9	40
7,5 x 80				25									
7,5 x 100				45									
7,5 x 120				65									
7,5 x 140				85									
7,5 x 160				105									

Setting tool: Electrical tangential impact wrench, max. power rating T<sub>max</sub> according to manufacturer's data, recommended T<sub>max</sub>: 250 Nm for Rock 7,5 x L; 450 Nm for Rock 10,5 x L and 12,5 x L and 16,5 L.

Note: A higher max. torque of the setting tool can lead to destruction of the drilling hole or damage to the screw.

Assembly with torque wrench: Recommended installation torque T<sub>inst</sub>: 20 Nm for Rock 7,5 x L; 40 Nm for Rock 10,5 x L and 120 Nm for 16,5 x L.

a) The calculation for a joint is to be performed according to ETAG-001 Annex C. b) Partial safety factors:  $\gamma_{Mk,V} = 1,5$ ;  $\gamma_{Mk,W} = 1,5$ .

Please note: These are planning aids. Projects must only be calculated by authorised persons.

by phone 02331 6245-444 · by fax 02331 6245-200 · by e-mail [technik@eurotec.team](mailto:technik@eurotec.team)

Please contact our technical department or use the free [calculation services](#) in the service section of our website.

## Contact

Trader:	_____	Contractor:	_____
Contact Person:	_____	Contact Person:	_____
e-mail:	_____	Phone:	_____
Project:	_____	e-mail:	_____

## Project details

### Concrete

Strength category: \_\_\_\_\_  
(if known; min. C20/25)

Construction component: \_\_\_\_\_  
(e.g. strip footing, floor slab, wall, ceiling, etc.)

Component thickness h: \_\_\_\_\_ mm

### Attachment

Steel     Wood \_\_\_\_\_  
strength class of wooden attachment

Attachment thickness: \_\_\_\_\_ mm

Diameter of through hole: \_\_\_\_\_ mm

**Loads (rated values)** \_\_\_\_\_ mm

Normal force along X axis:  $N_d$ : \_\_\_\_\_ kN

Shear force along Y axis:  $V_{y,d}$ : \_\_\_\_\_ kN

Shear force along Z axis:  $V_{z,d}$ : \_\_\_\_\_ kN

Moment around X axis:  $M_{x,d}$ : \_\_\_\_\_ kNm

Moment around Y axis:  $M_{y,d}$ : \_\_\_\_\_ kNm

Moment around Z axis:  $M_{z,d}$ : \_\_\_\_\_ kNm

A detailed sketch of the joint must be enclosed with the inquiry, stating the following details:

- Geometry of concrete and attachment
- Edge and centre distances  $C$  and  $S$
- Position of attachment relative to concrete component
- Position (and angle, where applicable) of force application point on the attachment

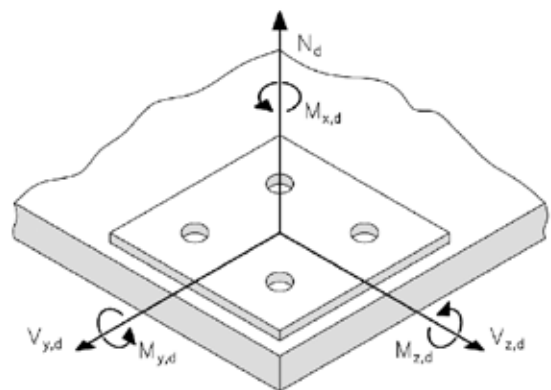
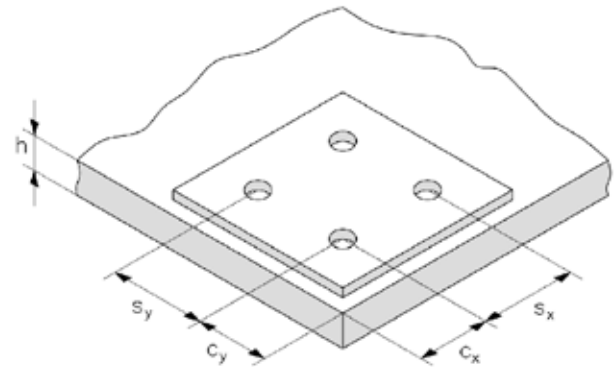

## Screw selection

- |  |   |   |
|--|---|---|
| <input type="checkbox"/> Ø 7,5 mm countersunk head | <input type="checkbox"/> Ø 10,5 mm hex head         | <input type="checkbox"/> Ø 12,5 mm hex, flange      |
| <input type="checkbox"/> Ø 7,5 mm hex head, flange | <input type="checkbox"/> Ø 7,5 mm hex head          | <input type="checkbox"/> Ø 10,5 mm hex head, flange |
| <input type="checkbox"/> Ø 7,5 mm hex head         | <input type="checkbox"/> Ø 10,5 mm hex head, flange | <input type="checkbox"/> Ø 12,5 hex head, flange    |



# Bolt anchor A4 / Bolt anchor

For fastening in concrete

## Bolt anchor A4

With washer, Stainless steel A4, for cracked concrete and non-cracked concrete



## Bolt anchor

With washer, electrogalvanised, for non-cracked concrete



### Torque-controlled expanding plug

The Eurotec bolt anchor is a torque-controlled expanding plug made of electrogalvanised steel for through-hole mounting in uncracked concrete. The special thing about the bolt anchor is that it is possible to maintain small centre and edge distances despite the high load-bearing capacity. Different anchoring depths and various sizes mean the bolt anchor can be used in a variety of ways. Every bolt anchor is fitted with an expansion clip, which ensures high load-bearing capacity and means less fastening points are needed.

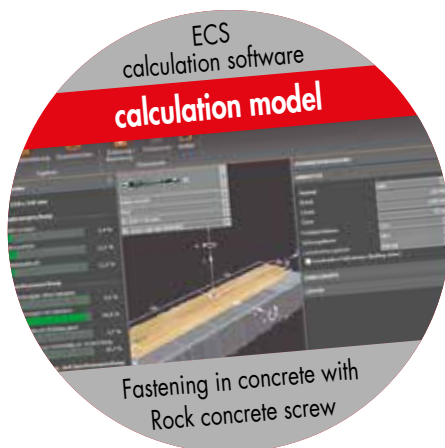

Art. no.	Dimensions [mm]	Head	PU
946142	8,0 x 75	SW13	100
946143	8,0 x 100	SW13	100
946144	10,0 x 100	SW17	50
946145	10,0 x 120	SW17	50
946146	10,0 x 140	SW17	50
946148	12,0 x 140	SW19	25

Art. no.	Dimensions [mm]	Head	PU
946170 *	6,0 x 55	SW10	200
946171 *	6,0 x 85	SW10	100
946172 *	8,0 x 50	SW13	100
946173	8,0 x 75	SW13	100
946174	8,0 x 95	SW13	100
946175	8,0 x 115	SW13	100
946176	8,0 x 135	SW13	50
946177 *	10,0 x 60	SW17	100
946178	10,0 x 80	SW17	50
946179	10,0 x 100	SW17	50
946180	10,0 x 120	SW17	50
946181	10,0 x 140	SW17	50
946182 *	12,0 x 80	SW19	50
946183	12,0 x 95	SW19	50
946184	12,0 x 110	SW19	50
946185	12,0 x 130	SW19	25
946186	12,0 x 160	SW19	25
946187	12,0 x 180	SW19	25
946188	16,0 x 125	SW24	20
946189	16,0 x 140	SW24	20
946190	16,0 x 180	SW24	10
To DIN 440:			
946191	12,0 x 200	SW19	20
946192	12,0 x 220	SW19	20
946193	12,0 x 240	SW19	15
946194	12,0 x 260	SW19	15
946195	16,0 x 220	SW24	10
946196	16,0 x 240	SW24	10
946197	16,0 x 260	SW24	10

\* Screws not regulated by ETA-14/0409

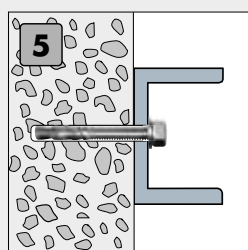
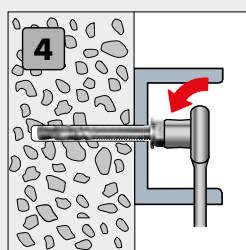
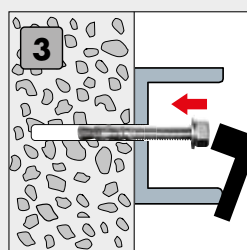
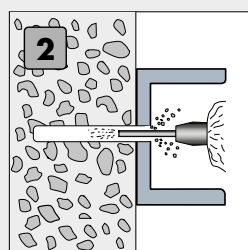
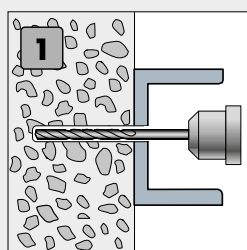

### Application

1 Create drill hole

2 Clean drill hole thoroughly

3 Drive in bolt anchor with a hammer

4 Screw on the hexagonal nut until the appropriate torque is reached

5 Done!

## Technical information

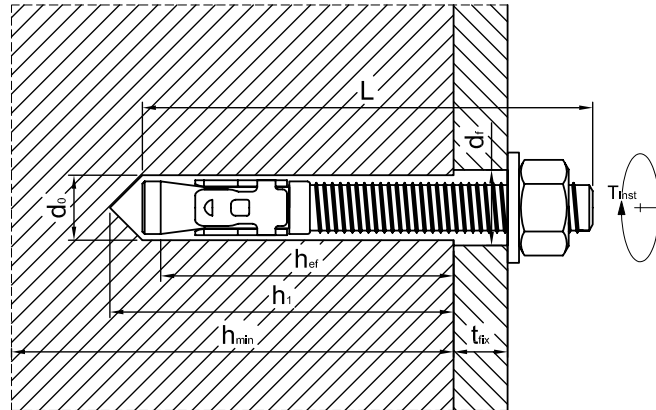

Dimensions [mm]	min. Subsurface thickness $h_{min}$ [mm]	Drill diameter $d_0$ [mm]	min. Depth of drill hole $h_1$ [mm]	min. Depth of drill hole $h_{ef}$ [mm]	max. Drill diameter in attached part $d_i$ [mm]	max. attachment thickness $t_{fix}$ [mm]	Installation torque $T_{inst}$ [Nm]
$\emptyset \times$ Length							

Bolt anchor with washer according to DIN 125A

6,0 x 55 *	100	6	50	35	7	5	11
6,0 x 85 *	100	6	50	35	7	35	11
8,0 x 50 *	100	8	55	30	9	5	15
8,0 x 75	100	8	55	40	9	15	15
8,0 x 95	100	8	55	40	9	35	15
8,0 x 115	100	8	55	40	9	55	15
8,0 x 135	100	8	55	40	9	75	15
10,0 x 60 *	100	10	65	30	12	5	25
10,0 x 80	100	10	65	50	12	5	25
10,0 x 100	100	10	65	50	12	25	25
10,0 x 120	100	10	65	50	12	45	25
10,0 x 140	100	10	65	50	12	65	25
12,0 x 80 *	110	12	80	50	14	5	40
12,0 x 95	110	12	80	65	14	5	40
12,0 x 110	110	12	80	65	14	20	40
12,0 x 130	110	12	80	65	14	40	40
12,0 x 160	110	12	80	65	14	70	40
12,0 x 180	110	12	80	65	14	90	40
16,0 x 125	120	16	90	80	18	15	80
16,0 x 140	120	16	90	80	18	30	80
16,0 x 180	120	16	90	80	18	70	80

Bolt anchor with washer according to DIN 440

12,0 x 200	110	12	80	65	14	110	40
12,0 x 220	110	12	80	65	14	130	40
12,0 x 240	110	12	80	65	14	150	40
12,0 x 260	110	12	80	65	14	170	40
16,0 x 220	120	16	90	80	18	110	80
16,0 x 240	120	16	90	80	18	130	80
16,0 x 260	120	16	90	80	18	150	80

Bolt anchor A4

8,0 x 75	100	8	60	45	9	15	20
8,0 x 100	100	8	60	45	9	40	20
10,0 x 100	120	10	75	60	12	25	45
10,0 x 120	120	10	75	60	12	45	45
10,0 x 140	120	10	75	60	12	65	45
12,0 x 140	140	12	85	70	14	50	60

\* Not regulated by ETA-14/0409



# Porous concrete screw 1000, EMD Multi plug

## Porous concrete screw 1000

Countersunk head screw, specially coated steel



Art. no.	Dimensions [mm]	Drive	PU
944818	8,0 x 90	TX30 ●	50
944819	8,0 x 100	TX30 ●	50
944820	8,0 x 120	TX30 ●	50
944821	8,0 x 140	TX30 ●	50
944822	8,0 x 160	TX30 ●	50
944823	10,0 x 140	TX40 ●	50
944824	10,0 x 180	TX40 ●	50

### Advantages/properties

- Corrosion-resistant for up to 1,000 h in salt spray test
- Quicker and easier assembly/dismantling
- No pilot-drilling necessary
- High thread pitch  
→ Quick screw insertion
- Plug-free installation minimises wall damage and saves time
- No need to countersink battens
- Excellent corrosion protection thanks to special coating
- Case-hardened

### Field of application

- Only for component fastenings of minor importance on aerated concrete

Art. no.	Dimension $\varnothing d \times L$ [mm]	Head diameter $\varnothing d_h$ [mm]	min. Embedment depth $h_{nom, min}$ [mm]	max. Fixture thickness $t_{fix, max}$ [mm]	Design value Pull-out resistance $N_{u, Rd}^{a)}$ [kN]	PU
944818	8,0 x 90	12	75	15	0,6	50
944819	8,0 x 100	12	75	25	0,6	50
944820	8,0 x 120	12	75	45	0,7	50
944821	8,0 x 140	12	80	60	0,7	50
944822	8,0 x 160	12	80	80	0,7	50
944823	10,0 x 140	14,5	95	45	0,9	50
944824	10,0 x 180	14,5	95	85	0,9	50

a) For aerated concrete PP4 (4,0 MPa; 550 kg/m<sup>3</sup>),  $\gamma_M, U = 2,5$

## EMD Multi plug

Plastic, with collar



### Advantages

- For chipboard screws and wood construction screws
- The collar prevents the plug from penetrating too deep into the drill hole
- The anti-twist element prevents it from turning with the screw in the hole

Art. no.	Dimensions [mm]	Drill $\varnothing$ subsurface [mm]	Min. depth of drill hole [mm]	$\varnothing$ Screws [mm]	PU
200000	6,0 x 36	6	45	4,0	200
200001	8,0 x 50	8	60	4,5	200
200002	10,0 x 60	10	70	6,0	100
200003	12,0 x 70	12	80	8,0	50

# Injection mortar

Chemical fastening system supplied as a cartridge



## What can they be used for?

- For anchorages in cracked and non-cracked concrete and anchorages in masonry
- For installations where very small edge and axial distances are required
- Anchorages in porous bricks

## Advantages

- Broad range of applications
- Straightforward application
- Optimum dosing
- Compatible with standard cartridge/silicon guns
- Suitable for wet anchoring substrates
- Free of harmful styrene
- Reclosable with screw cap

## Application

- Create drill hole (Rotary percussive with prescribed drill core diameter and selected drill hole depth).
- Clean drill hole using brush and blow pump (up to Ø 20 mm with hand pump; from Ø 20 mm or setting depth 240 mm with min. 6 bar oil-free compressed air).
- Open cartridge and screw on static mixer
- Press out the first part of the mortar until the mixture reaches a uniform grey colour
- Fill the drill hole from the bottom to approx. 2/3 height → Pulling the cartridge out slowly prevents the formation of air pockets
- Introduce anchor rod, rotating it slightly, until it reaches the insertion depth
- Anchor rod must be free of dirt, grease and oil! → Hardening time varies depending on the temperature of the anchoring surface
- Mount attachment, observing the permissible tightening torque

## Note

- Always refer to the installation instructions of the European Technical Assessment during installation



## Injection mortar

300 ml, incl. static mixer



### Advantages/properties

- One fastening system, many application possibilities such as aerated concrete, sand-lime brick, brick and lightweight concrete block
- Anchorages in cracked and non-cracked concrete (ETA 20/0812)
- Anchorages in the masonry (ETA 20/0811)
- Commercially available reinforcing steel, threaded rods, washers and nuts included in the ETA assessment
- Suitable for water-filled drill holes in concrete
- Suitable for indoor use
  - Lowest emissions of critical substances in closed rooms after curing (class A+)
- Shelf life: 12 months
- Mortar colour: Grey
- Tested for use in earthquake-prone areas
- Good load values in concrete and masonry (for more information, see the product data sheet)
- Temperature range for use in concrete:
  - -40°C to +40°C (Maximum short-term temperature +40°C and maximum long-term temperature +24°C)
  - -40°C to +80°C (Maximum short-term temperature +80°C and maximum long-term temperature +50°C)
- Temperature range for use in masonry:
  - -40°C to +80°C (Maximum short-term temperature +80°C and maximum long-term temperature +50°C)

Art. no.	Cartridge type	Content [ml]	PU
200085	For standard silicone/cartridge guns	300	12

## Static mixer

For injection mortar cartridges



Art. no.	Cartridge socket	Working length [mm]	VPE
200084	M17	213	10

## Anchor rod

A4 stainless steel, incl. nut and washer

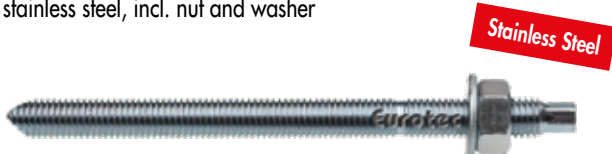

Art. no.	Dimensions [mm]	PU
200220	8 x 110	50
200221	10 x 130	25
200222	12 x 160	10
200223	16 x 190	10
200224	20 x 250	5

## Sieve sleeve



Art. no.	Dimensions [mm]	PU
200086	85 x Ø 16	10
200087	130 x Ø 20	10

## Anchor rod

Galvanised steel 5.8, inkl. nut and washer

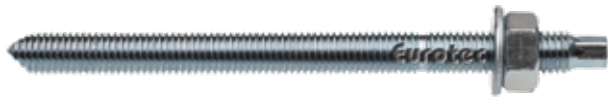

Art. no.	Dimensions [mm]	Art. no.	PU
200110	6 x 70		10
200111	8 x 110		10
200112	10 x 110		10
200113	10 x 130		10
200114	12 x 130		10
200115	12 x 160		10
200116	16 x 190		10
200117	20 x 260		5
200118	24 x 300		10

## Cleaning brush

For cleaning drill holes



Art. no.	Brush Ø [mm]	Art. no.	PU
200098	12		10
200099	14		10
200100	18		5
200101	24		5

## Blow pump

For cleaning drill holes



Art. no.	Hose diameter-Ø [mm]	Art. no.	PU
200097	9		1

## Cartridge gun

Manual compression, metal



Art. no.	Art. no.	PU
200096		1

## Pressure sleeve

Hard plastic



Art. no.	Dimensions [mm] <sup>a)</sup>	Art. no.	PU
200102	48 x 5		20
200103	48 x 10		20
200104	48 x 20		20
200105	48 x 30		20
200106	48 x 50		20
200107	48 x 100		20

a) Outside Ø x length

### Advantages/properties

- Outside diameter: 48 mm
- Inside diameter: 18 mm
- Material: Hard plastic
- For anchoring attachments at a distance, e. g. in the case of curtain walls
- With its large outside diameter and thick walls, the pressure sleeve reliably dissipates any compressive forces that arise into the anchoring surface
- Plastic reduces the formation of thermal bridges
- Can be extended as desired thanks to coupling mechanism
- Durable
- Resistant to temperature and weathering
- Resistant to acids, alkalis and other chemicals



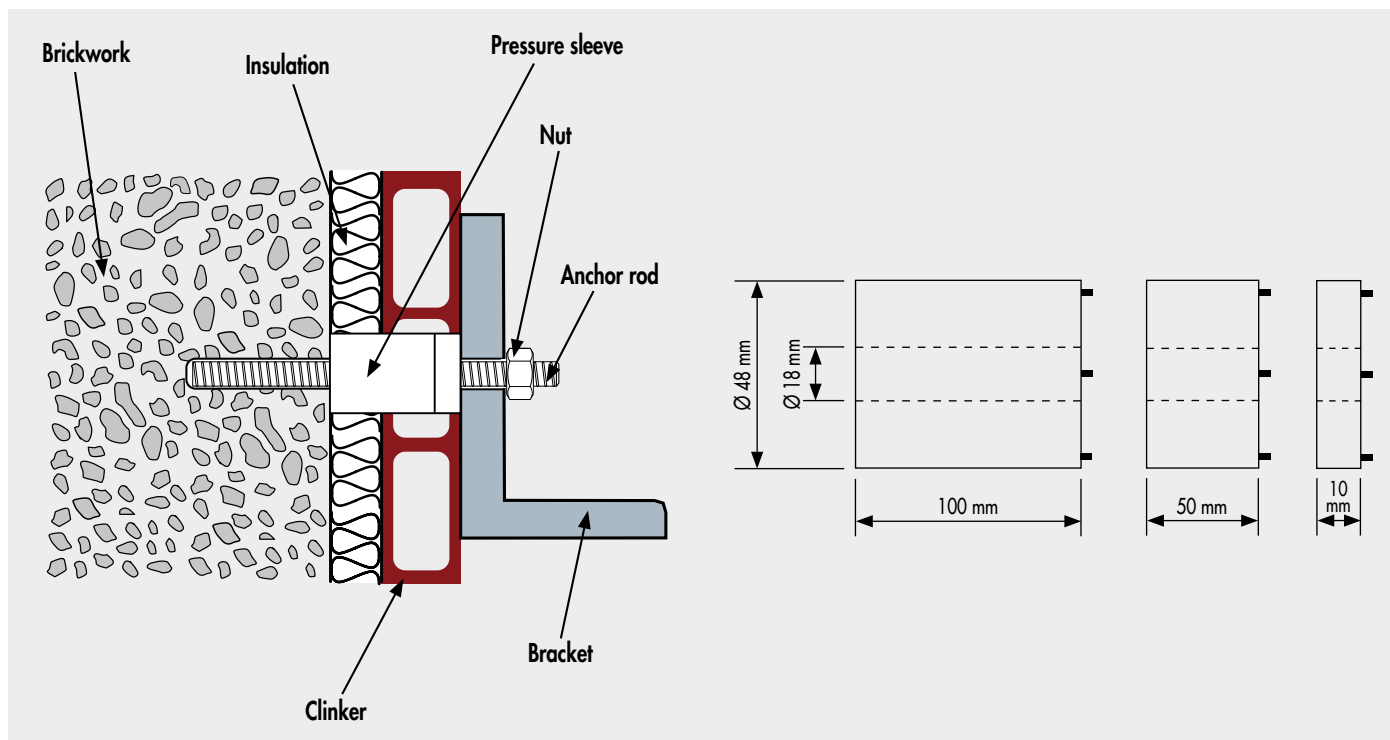

## Processing and curing times

Cartridge temperature [°C]	Concrete temperature [°C]	Max. Processing time [minutes]	Min. curing time [minutes]
+5 to +40	-5 to -1	90	360
	0 to +4	45	180
	+5 to +9	25	120
	+10 to +14	20	100
	+15 to +19	15	80
	+20 to +29	6	45
	+30 to +34	4	25
	+35 to +39	2	20



## Application example with concrete

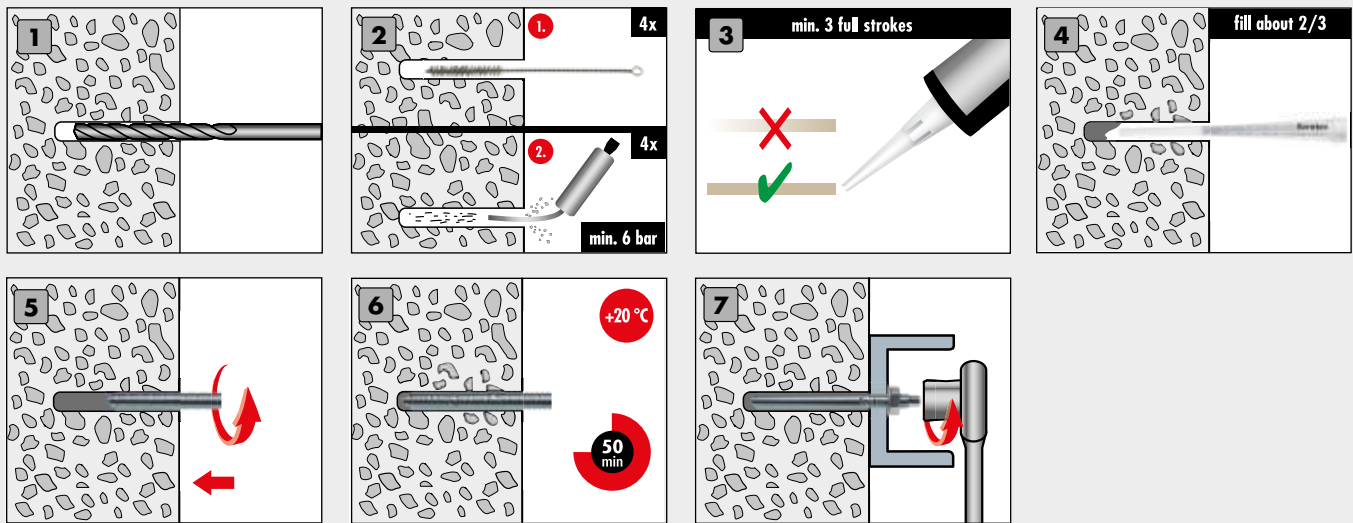

## Installation parameters in solid brick

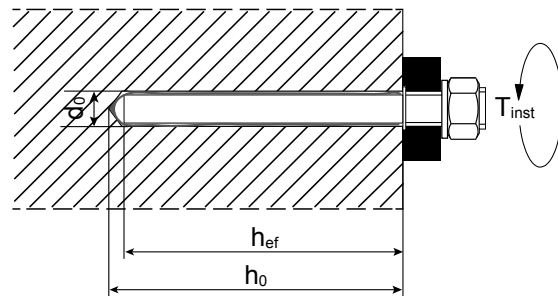

## Installation characteristics for aerated concrete and solid brick (without sieve sleeve)

Anchor size		M8 [mm]	M10 [mm]	M12 [mm]	M16 [mm]
Drill core diameter	$d_0$	10	12	14	18
Borehole depth	$h_0$	80	90	100	100
Effective anchorage depth	$h_{ef} = h_{nom}$	80	90	100	100
Minimum wall thickness	$h_{min}$	$h_{ef} + 30$	$h_{ef} + 30$	$h_{ef} + 30$	$h_{ef} + 30$
Through hole in the component to be connected	$d_t \leq$	9	12	14	18
Brush diameter	$d_b$	12	14	16	20
Minimum brush diameter	$d_{b,min}$	10,5	12,5	14,5	18,5

## Installation characteristics in solid brick and perforated brick (with sieve sleeve)

Anchor size		M8 [mm]	M8/M10 [mm]			M12/M16 [mm]		
Sieve case		SH 12 x 80	SH 16 x 85	SH 16 x 130	SH 16 x 130/330	SH 20 x 85	SH 20 x 130	SH 20 x 200
Drill core diameter	$d_0$	12	16	16	16	20	20	20
Borehole depth	$h_0$	85	90	135	$135 + t_{sx}$	90	135	205
Effective anchorage depth	$h_{ef} = h_{nom}$	80	85	130	130	85	130	200
Minimum wall thickness	$h_{min}$	115	115	175	175	115	175	240
Through hole in component to be connected	$d_t \leq$	9	9 (M8) / 12 (M10)			14 (M12) / 18 (M16)		
Brush diameter	$d_b$	14	18	18	18	22	22	22
Minimum brush diameter	$d_{b,min}$	12,5	16,5	16,5	16,5	20,5	20,5	20,5

## Installation parameters in cracked and non-cracked concrete

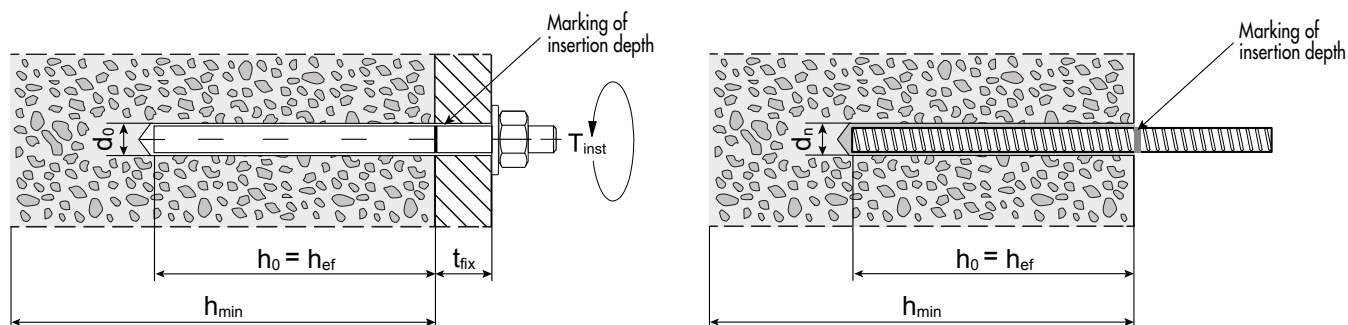

## Installation characteristics in cracked and non-cracked concrete ETA

		Threaded rod					
		M8 [mm]	M10 [mm]	M12 [mm]	M16 [mm]	M20 [mm]	M24 [mm]
Diameter threaded rod	$d = d_{nom}$	8	10	12	16	20	24
Drill core diameter	$d_0$	10	12	14	18	24	28
Effective anchorage depth	$h_{ef,min}$	60	60	70	80	90	96
	$h_{ef,max}$	160	200	240	320	400	480
Through hole in component to be connected	Pre-assembly $d_i$	9	12	14	18	22	26
	Push-through mounting $d_i$	12	14	16	20	24	30
Brush diameter	$d_b \geq$	12	14	16	20	26	30
Mounting thickness	$T_{fix,min} >$	0	0	0	0	0	0
	$T_{fix,max} <$	1500	1500	1500	1500	1500	1500
Minimum component thickness	$h_{min}$	$h_{ef} + 30 \geq 100$	$h_{ef} + 30 \geq 100$	$h_{ef} + 30 \geq 100$	$h_{ef} + 2d_0$	$h_{ef} + 2d_0$	$h_{ef} + 2d_0$
Minimum centre distance	$s_{min}$	40	50	60	80	100	120
Minimum edge distance	$c_{min}$	40	50	60	80	100	120

		Threaded rod					
		M8 [Nm]	M10 [Nm]	M12 [Nm]	M16 [Nm]	M20 [Nm]	M24 [Nm]
Torque	$T_{inst} \leq$	10	20	40	80	120	160

		Reinforcing steel <sup>1)</sup>						
		Ø-8 [mm]	Ø-10 [mm]	Ø-12 [mm]	Ø-14 [mm]	Ø-16 [mm]	Ø-20 [mm]	Ø-25 [mm]
Diameter reinforcing steel	$d = d_{nom}$	8	10	12	14	16	20	25
Drill core diameter	$d_0$	12	14	16	18	20	25	32
Effective anchorage depth	$h_{ef,min}$	60	60	70	75	80	90	100
	$h_{ef,max}$	160	200	240	280	320	400	500
Brush diameter	$d_b \geq$	14	16	18	20	22	27	34
Minimum component thickness	$h_{min}$	$h_{ef} + 30 \geq 100$	$h_{ef} + 30 \geq 100$	$h_{ef} + 2d_0$	$h_{ef} + 2d_0$	$h_{ef} + 2d_0$	$h_{ef} + 2d_0$	$h_{ef} + 2d_0$
Minimum centre distance	$s_{min}$	50	55	65	70	80	100	130
Minimum edge distance	$c_{min}$	50	55	65	70	80	100	130

1) For use in non-cracked concrete only

# Frame fixing

Set consisting of fixing and screw



## ERD SK frame fixing

Countersunk head

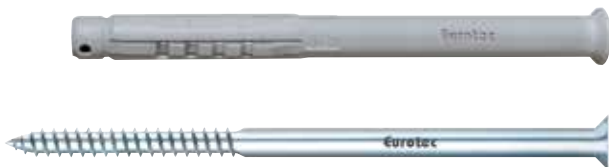

### Advantages

- Through-hole mounting
- Ready for loading immediately
- The hammer-in stop prevents premature expansion of the plug during installation



Art. no.	Dimensions [mm]	Drive	PU
200012	10,0 x 80	TX40 ●	50
200013	10,0 x 100	TX40 ●	50
200014	10,0 x 120	TX40 ●	50
200015	10,0 x 140	TX40 ●	50
200016	10,0 x 160	TX40 ●	50
200017	10,0 x 180	TX40 ●	50
200018	10,0 x 200	TX40 ●	50
200019	10,0 x 230	TX40 ●	25
200020	10,0 x 260	TX40 ●	25

## ERD ZK frame fixing

Cylinder head



### Advantages

- Through-hole mounting
- Ready for loading immediately
- The hammer-in stop prevents premature expansion of the plug during installation



Art. no.	Dimensions [mm]	Head	PU
200021	10,0 x 80	SW13	50
200022	10,0 x 100	SW13	50
200023	10,0 x 120	SW13	50
200024	10,0 x 140	SW13	50
200025	10,0 x 160	SW13	50
200026	10,0 x 180	SW13	50

## Application example with brickwork

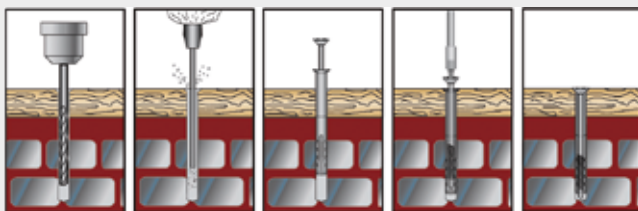

## Application example with concrete

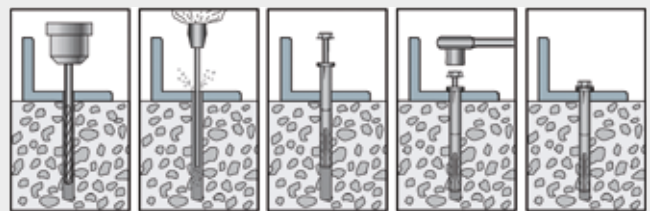

**Our hint:** Drill using rotary mode for perforated bricks and hollow blocks. Do not use hammer mode! Remove the drillings from the drill hole!



## Technical information

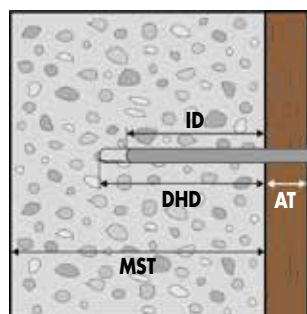

AT = Attachment thickness

ID = Insertion depth

DHD = Drill-hole depth

MST = Minimum subsurface thickness

ERD frame fixing SK	Art. no.	Dimensions plug [mm]	Drive screw	Drill Ø subsurface [mm]	min. Drill hole depth DHD [mm]	min. Plug insertion depth ID [mm]	max. Drill Ø in attached part [mm]	max. Attachment thickness AT [mm]
	200012	Ø 10 x 80	TX40	10	70	60	10,5	20
	200013	Ø 10 x 100	TX40	10	70	60	10,5	40
	200014	Ø 10 x 120	TX40	10	70	60	10,5	60
	200015	Ø 10 x 140	TX40	10	70	60	10,5	80
	200016	Ø 10 x 160	TX40	10	70	60	10,5	100
	200017	Ø 10 x 180	TX40	10	70	60	10,5	120
	200018	Ø 10 x 200	TX40	10	70	60	10,5	140
	200019	Ø 10 x 230	TX40	10	70	60	10,5	170
	200020	Ø 10 x 260	TX40	10	70	60	10,5	200

ERD frame fixing SK	Art. no.	Dimensions plug [mm]	Head screw	Drill Ø subsurface [mm]	min. Drill hole depth DHD [mm]	min. Plug insertion depth ID [mm]	max. Drill Ø in attached part [mm]	max. Attachment thickness AT [mm]
	200021	Ø 10 x 80	SW13	10	70	60	10,5	20
	200022	Ø 10 x 100	SW13	10	70	60	10,5	40
	200023	Ø 10 x 120	SW13	10	70	60	10,5	60
	200024	Ø 10 x 140	SW13	10	70	60	10,5	80
	200025	Ø 10 x 160	SW13	10	70	60	10,5	100
	200026	Ø 10 x 180	SW13	10	70	60	10,5	120

Subsurface	Strength class <sup>a)</sup>	Char. load-bearing capacity $N_{Rk,p}$ [kN]	Drilling method <sup>b)</sup>	min. Subsurface thickness MST [mm]	min. Edge distance [mm]	min. Centre distance [mm]
Concrete	C12/15	3,0	S	100	140	110
	≥ C16/20	4,5				
Vertically perforated brick DIN 105	HLz 6 - 0,7	0,4	D	100	100	250
	HLz 8 - 0,9	0,4				
	HLz 10 - 0,9	0,5				
	HLz 12 - 0,9	0,6				
Hollow block made of lightweight concrete DIN EN771-3	Hbl 4 - 1,2	1,5	D	100	100	250
Perforated sand-lime brick DIN 106	KSL 8 - 1,4	1,5	D	100	100	250
	KSL 10 - 1,4	1,5				
	KSL 12 - 1,4	2,0				
Solid sand-lime brick DIN 106	KS 10 - 2,0	1,2	D	100	150	250
	KS 20 - 2,0	1,5				
	KS 28 - 2,0	2,0				
Solid lightweight concrete brick DIN 18152	V 4 - 1,2	1,5	D	100	100	250
	V 6 - 1,2	2,0				
Masonry brick DIN 105	Mz 10 - 1,8	3,0	S	100	100	250
	Mz 20 - 1,8	4,0				

a) Indication of strength class of masonry blocks: e. g. Mz 10 - 1,8 = masonry brick with min. compressive strength 10 N/m<sup>2</sup> and min. bulk density of 1,8 kg/m<sup>3</sup>

b) H = Hammer drilling, R = Rotary drilling

# Rigid foam plug, Gypsum board plug

## Rigid foam plug

Plastic

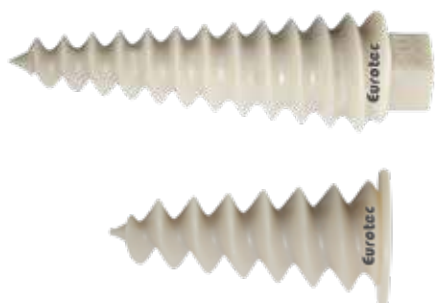

Art. no.	Dimensions [mm]	For screw Ø*	Drive	PU
200060	20 x 50	4,0 - 4,5	TX30 •	50
200061	30 x 95	8,0 / M8	TX55 + SW17	50
200062	30 x 95	10,0 / M10	SW17	50

\*Screw not included

- For anchorages in expanded polystyrene, rigid foam boards and other soft building materials
- The plug has a TX/hexagon drive and is screwed in in a straightforward and time-saving manner with no need for pilot drilling

## Gypsum board plug

Incl. setting tool



Art. no.	For screw Ø*	PU
200056	3,5 - 5,0 mm	100

\*Screw not included

- For anchorages in plasterboard/gypsum board
- The plug is screwed directly into the plasterboard/gypsum board in a straightforward and time-saving manner using the setting tool
- Suitable for wood or chipboard screws with Ø of Ø 3,5 - 5,0 mm

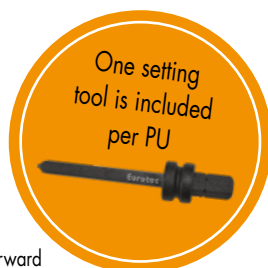

# Insulating stud anchor, Nail plug, Express nail, Glazing blocks

## Insulating stud anchor

Zinc die-cast



### Advantages

- No pre-drilling for soft materials
- Direct installation without separate anchors
- Sealing disc included
- Installation without thermal bridges
- No impact to the screws thanks to TX drive

### Suitable building materials

- External thermal insulation composite systems (ETICs)
- Polystyrene panels (EPS, XPS)
- Rigid foam boards
- Foamed polystyrene panels

### Description

The Eurotec stud anchor is suitable for direct anchoring in polystyrene, rigid foam panels and other soft construction materials. The conical shape of the anchor ensures that the material is compacted in the area of the screw-in point, holding the anchor firmly in place.

Art. no.	Dimensions [mm]	Thread length [mm]	Drive	PU
200036	13 x 65	65	TX30 •	100

## END Nail plug

Countersunk head, set consisting of plug and screw



### Advantages

- Fast and efficient installation
- Saves time thanks to preinstalled threaded nail
- Especially suited to working with timber and lightweight-construction profiles
- Easy to remove with crosshead drive

Art. no.	Dimensions [mm]	Drive	PU
200004	5,0 x 30	PZ 2	200
200005	5,0 x 40	PZ 2	200
200006	6,0 x 40	PZ 2	200
200007	6,0 x 60	PZ 2	200
200008	6,0 x 80	PZ 2	200
199996	6,0 x 100	PZ 2	200
199997	8,0 x 50	PZ 2	100
200009	8,0 x 60	PZ 2	100
200010	8,0 x 80	PZ 2	100
200011	8,0 x 100	PZ 2	100
199998	8,0 x 120	PZ 2	100
199999	8,0 x 140	PZ 2	100

## Application example

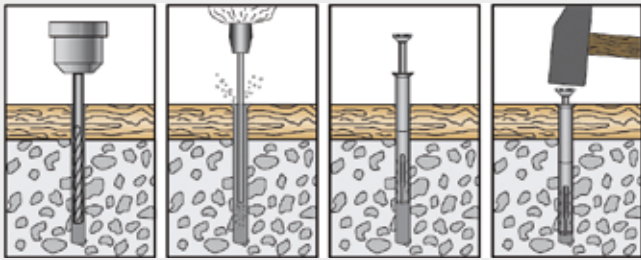

Art. no.	Dimensions [mm]	Drill Ø subsurface [mm]	min. Drill hole depth DHD [mm]	min. Plug insertion depth ID [mm]	max. Drill Ø in attached part [mm]	max. Attachment thickness AT [mm]
200004	Ø 5 x 30	5	30	20	5	10
200005	Ø 5 x 40	5	30	20	5	20
200006	Ø 6 x 40	6	35	25	6	15
200007	Ø 6 x 60	6	35	25	6	35
200008	Ø 6 x 80	6	35	25	6	55
199996	Ø 6 x 100	6	55	25	6	60
199997	Ø 8 x 50	8	50	40	8	10
200009	Ø 8 x 60	8	50	40	8	20
200010	Ø 8 x 80	8	50	40	8	40
200011	Ø 8 x 100	8	50	40	8	60
199998	Ø 8 x 120	8	50	40	8	80
199999	Ø 8 x 140	8	50	40	8	100

## Express nail

Galvanised



- The express nail is used for lightweight fastenings in concrete and brickwork; it grips over its entire length in the drilled hole. It is used in concrete, natural stone, dense structures, solid brick and solid sand lime brick

- Perfectly suited to attaching: e. g. squared timbers, timber and metal substructures and metal profiles

### Advantages

The wax coating makes it easy to hammer into the drilled hole. No screws or plugs are needed

Art. no.	Dimensions [mm]	Attachment thickness [mm]	PU
110143	6,0 x 30	3	200
110144	6,0 x 40	10	200
110145	6,0 x 50	20	200
110146	6,0 x 60	30	200
110147	6,0 x 80	50	200
900089	6,0 x 100	70	200
110148	8,0 x 70	30	100
110149	8,0 x 90	50	100
110150	8,0 x 110	70	100
110151	8,0 x 130	90	100
110152	8,0 x 150	110	100
110153	8,0 x 180	140	100

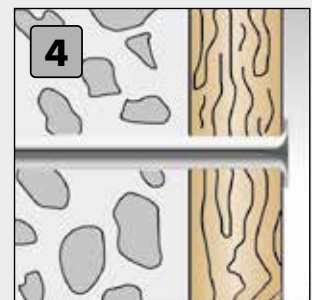
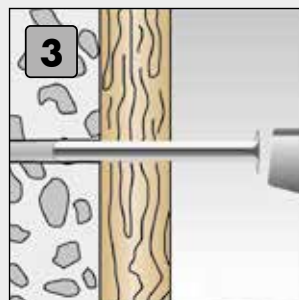
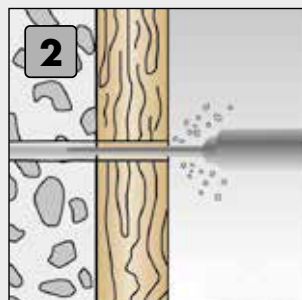
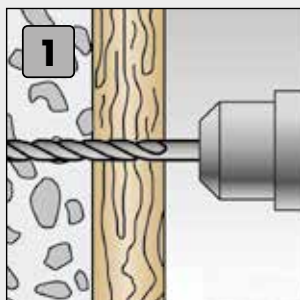



# Sealing plug, Impact rivets, Ceiling anchor

## Sealing plug

With neoprene seal



- Plastic plug with cross-head screw and seal ring
- After installation, the premounted seal ring reliably prevents moisture from penetrating into the component through the drill hole

### Especially suitable for

- Anchorages in concrete, solid bricks, sand-lime bricks and other high-strength building materials

Art. no.	Dimensions [mm]	Drive	PU
Stainless steel A2			
200050	6,0 x 30	PZ 2	200
200051	6,0 x 40	PZ 2	200
200052	6,0 x 50	PZ 2	100
200053	6,0 x 60	PZ 2	100
Stainless steel, copper			
200040	6,0 x 30	PZ 2	200
200041	6,0 x 40	PZ 2	200
200042	6,0 x 50	PZ 2	100
200043	6,0 x 60	PZ 2	100

## Technical data

Art. no.	Type	Plug	Nail	Seal ring	Plug	Nail	Drill Ø subsurface	min. Drill hole depth DHD	min. Plug insertion depth ID	max. Drill Ø in attached part	max. Attachment thickness AT
200050	Stainless steel A2	6	4	15	30	35	6	35	25	6	5
200051	Stainless steel A2	6	4	15	40	42	6	35	25	6	15
200052	Stainless steel A2	6	4	15	50	52	6	35	25	6	25
200053	Stainless steel A2	6	4	15	60	62	6	35	25	6	35
200040	Stainless steel, copper	6	4	15	30	35	6	35	25	6	5
200041	Stainless steel, copper	6	4	15	40	42	6	35	25	6	15
200042	Stainless steel, copper	6	4	15	50	52	6	35	25	6	25
200043	Stainless steel, copper	6	4	15	60	62	6	35	25	6	35

## Impact rivets

Aluminium rivet body/stainless-steel mandrel



Art. no.	Shaft Ø rivet length [mm]	Drill Ø [mm]	max. Attachment thickness [mm]	PU
111246	4,8 x 16	5,0	11,0	200
111247	4,8 x 20	5,0	15,0	200
111248	4,8 x 26	5,0	20,0	200
111249	4,8 x 30	5,0	25,0	200
111250	4,8 x 35	5,0	30,0	200
111251	4,8 x 40	5,0	35,0	200
111252	4,8 x 50	5,0	45,0	200

### Impact fastening of

- Aluminium, sheet-metal, wall-end and roof-edge profiles
- Chimney flashing, wall coping
- Skylights, roof gullies, roof hatches, smoke extractors, flues
- Moisture-proof roofing sheets, flat-roof end profiles
- Linings and membrane connections for swimming pools
- Flange fastenings
- Frames, door and window frames
- Battens, insulation material
- Floor coverings and much more

## Ceiling anchor

Galvanised



Art. no.	Dimensions [mm]	Art. no.	PU
110000	6,0 x 40		200
110001	6,0 x 65		200

### Application

- Pilot-drill the base material to the desired depth (but at least 40 mm) with a diameter of 6 mm
- Minimum anchoring depth in the concrete: 32 mm
- Insert the ceiling anchor through the pre-drilled attachment
- Hammer in the pin

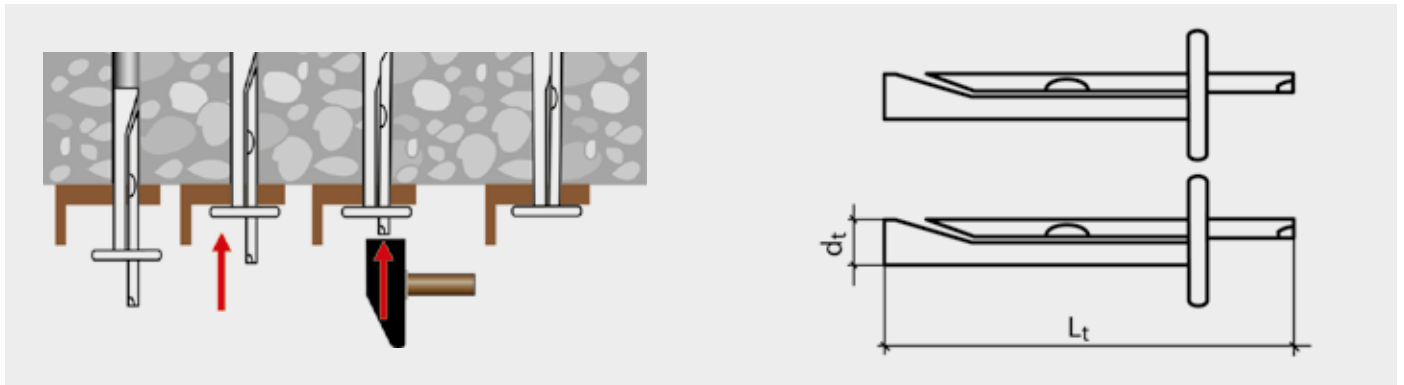

## Glazing blocks



### Advantages

- High load-bearing capacity
- Compatibility with many edge-sealing compounds
- Ageing resistance
- Temperature resistance

Art. no.	Dimensions [mm] <sup>a)</sup>	Colour	Art. no.	PU
964588	100 x 22 x 1	Blue		1000
964589	100 x 22 x 2	White		1000
964590	100 x 22 x 3	Anthracite		1000
964591	100 x 22 x 4	Black		1000
964592	100 x 22 x 5	Brown		1000
964593	100 x 24 x 2	White		1000
964594	100 x 24 x 3	Anthracite		1000
964595	100 x 24 x 4	Black		1000
964597	100 x 30 x 1	Blue		1000
964598	50 x 22 x 1	Blue		1000
964599	50 x 22 x 2	White		1000
964600	50 x 22 x 3	Anthracite		1000
964601	50 x 22 x 5	Brown		1000
964602	100 x 30 x 3	Anthracite		1000
964603	50 x 22 x 4	Black		1000
964605	100 x 30 x 2	White		1000
964606	50 x 15 x 2	White		1000
964607	50 x 15 x 3	Anthracite		1000
964608	50 x 15 x 4	Black		1000

a) Length x width x height

# Window frame screws, Mounting disc, Level Max

## Concrete frame screw

Cylinder head, blue galvanised steel



### Application

- Pilot-drill the frame to  $\varnothing 6,2$  mm; insert and align window
- Pilot-drill the anchoring surface to  $\varnothing 6,0$ ; screw in concrete frame screws



Art. no.	Dimensions [mm]	Drive	Thread	Head $\varnothing$ [mm]	PU
B110069	7,5 x 42	TX25 ●	FT	7,5	100
B944847	7,5 x 52	TX25 ●	FT	7,5	100
B900905	7,5 x 62	TX25 ●	FT	7,5	100
B110070	7,5 x 72	TX25 ●	FT	7,5	100
B900906	7,5 x 82	TX25 ●	FT	7,5	100
B110071	7,5 x 92	TX25 ●	FT	7,5	100
B900907	7,5 x 102	TX25 ●	FT	7,5	100
B110072	7,5 x 112	TX25 ●	FT	7,5	100
B900725	7,5 x 122	TX25 ●	FT	7,5	100
B110073	7,5 x 132	TX25 ●	FT	7,5	100
B110074	7,5 x 152	TX25 ●	FT	7,5	100
B110075	7,5 x 182	TX25 ●	FT	7,5	100
B110076	7,5 x 212	TX25 ●	FT	7,5	100
B901087	7,5 x 42	TX30 ●	FT	8,5	100
B900023	7,5 x 62	TX30 ●	FT	8,5	100
B900017	7,5 x 72	TX30 ●	FT	8,5	100
B900018	7,5 x 82	TX30 ●	FT	8,5	100
B900019	7,5 x 92	TX30 ●	FT	8,5	100
B900021	7,5 x 102	TX30 ●	FT	8,5	100
B900024	7,5 x 112	TX30 ●	FT	8,5	100
B900020	7,5 x 122	TX30 ●	FT	8,5	100
B900025	7,5 x 132	TX30 ●	FT	8,5	100
B900707	7,5 x 152	TX30 ●	FT	8,5	100
B900383	7,5 x 182	TX30 ●	FT	8,5	100
B901034	7,5 x 212	TX30 ●	FT	8,5	100
B944636	7,5 x 252	TX30 ●	DT	8,5	100
B944637	7,5 x 302	TX30 ●	DT	8,5	100

FT = fully threaded, DT = double-threaded

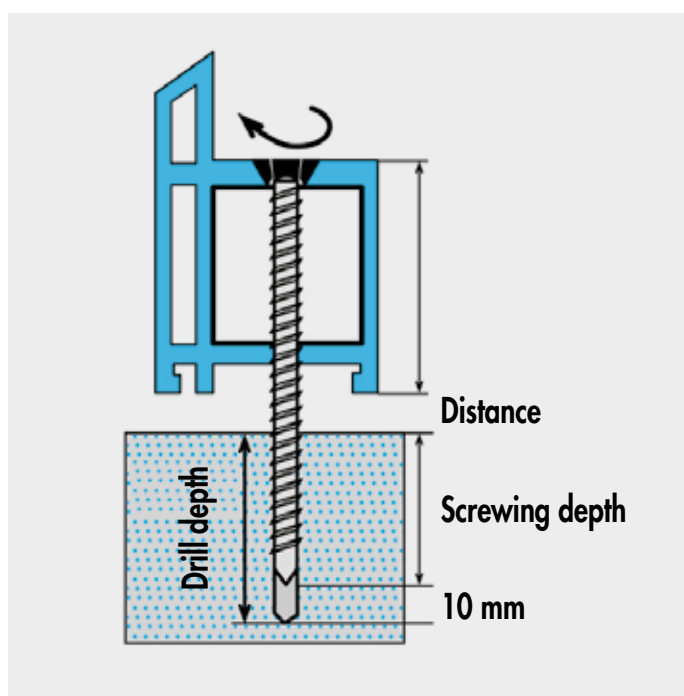

### Concrete frame screw

Countersunk head, blue galvanised steel



Art. no.	Dimensions [mm]	Drive	Thread	Head Ø [mm]	PU
B110061	7,5 x 42	TX30 ●	FT	11	100
B900903	7,5 x 52	TX30 ●	FT	11	100
B900620	7,5 x 62	TX30 ●	FT	11	100
B110062	7,5 x 72	TX30 ●	FT	11	100
B900621	7,5 x 82	TX30 ●	FT	11	100
B110063	7,5 x 92	TX30 ●	FT	11	100
B900896	7,5 x 102	TX30 ●	FT	11	100
B110064	7,5 x 112	TX30 ●	FT	11	100
B900724	7,5 x 122	TX30 ●	FT	11	100
B110065	7,5 x 132	TX30 ●	FT	11	100
B110066	7,5 x 152	TX30 ●	FT	11	100
B110067	7,5 x 182	TX30 ●	FT	11	100
B110068	7,5 x 212	TX30 ●	DT	11	100
B944642	7,5 x 232	TX30 ●	DT	11	100
B944638	7,5 x 252	TX30 ●	DT	11	100
B944643	7,5 x 272	TX30 ●	DT	11	100
B944639	7,5 x 302	TX30 ●	DT	11	100
B944641	7,5 x 342	TX30 ●	DT	11	100
B944644	7,5 x 372	TX30 ●	DT	11	100
B944645	7,5 x 402	TX30 ●	DT	11	100

FT = fully threaded, DT = double-threaded

### Concrete frame screw

Panhead, galvanised steel

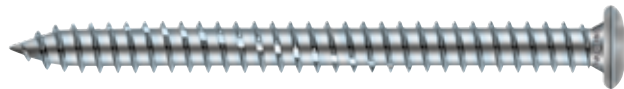

Art. no.	Dimensions [mm]	Drive	PU
B944661	7,5 x 42	TX30 ●	100
B944662	7,5 x 72	TX30 ●	100
B944663	7,5 x 82	TX30 ●	100
B944664	7,5 x 92	TX30 ●	100
B944665	7,5 x 112	TX30 ●	100
B944666	7,5 x 132	TX30 ●	100
B944667	7,5 x 152	TX30 ●	100
B944668	7,5 x 182	TX30 ●	100
B944669	7,5 x 212	TX30 ●	100

### Mounting disc

Senzimized steel



Art. no.	Plate-Ø [mm]	Ø Hole [mm]	PU
800308	40	7,35	—*

\* On request

- Versatile mounting disc for secure and uniform load distribution
- Can be combined with different screws, nails and plugs

### Mounting disc installation instructions

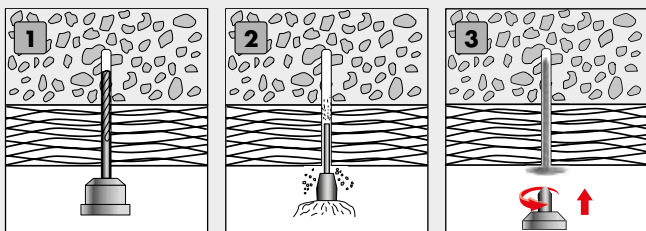



## Timber frame screw

Cylinder head, galvanised steel



### Advantages

- Complete seal
- Adapts perfectly
- Prevents the frame from warping
- Optimum load transmission
- Quick and easy dismantling  
→ Installation without pilot-drilling
- Plug-free installation minimises wall damage and saves time
- Unstressed window frame installation

### Application

- Suitable for timber window frames



Art. no.	Dimensions [mm]	Drive	PU
B944652	5,0 x 52	TX15 ●	200
B944653	5,0 x 62	TX15 ●	200
B944655	5,0 x 72	TX15 ●	200
B944656	5,0 x 82	TX15 ●	200
B944654	5,0 x 92	TX15 ●	200
B944657	5,0 x 102	TX15 ●	200
B944658	5,0 x 112	TX15 ●	200

## Level Max

Inflatable assembly cushion



### Advantages and properties

- Enormous time savings
- Accurate alignment down to the last millimetre
- Long-lasting and can be used as often as needed
- Easy operation
- Can be used with one hand
- Lifting force up to 100 kg

Art. no.	Dimensions [mm] <sup>a)</sup>	Total weight [g]	PU
800403	150 x 160	79	4

a) Assembly cushion







## Roof and Façade

BiGHTY drilling screw	414 - 416
Sandwich-panel screw	417
Roofing screw	417
Bugle-head screw	418
Fibre cement screw	419
Washed screw	420
Wall connecting bar	420
Coloured facade screw	421
Roof accessories	422 - 425
EiSYS-Aluminium/-Timber, EiSYS-2	426 - 432
Blue-Power façade mounting system	434 - 436
CoverFix facade guide rail	437
Klimax insulation-panel holder	438
Klimax insulation plug	439
Klimax ECO 1/ECO 2	439

# BiGHTY drilling screw

Fastening steel on steel/timber on steel/steel on timber



## What can they be used for?

- For steel/steel, timber/steel and steel/timber connections

## Properties

- Drills its own core hole and the counter-thread in the component itself
- This allows fastdrilling
- It is no longer necessary to centre-punch the drilling site
- High corrosion resistance

## Advantages

- A2 stainless steel, high corrosion resistance
- Tip: Carbon steel, high hardness and strength
- Stainless steel in accordance with DIN 10088
- Seal ring in A2 and EPDM
- Time-saving alternative to conventional self-tapping screws
- Screw can be screwed in with a commercially available spanner or socket spanner
- The specially shaped drill tip prevents the screw from drifting on the surface of the component



© Nicolette Vallentin - stock.adobe.com

BiGHTY drilling screw  
Bimetall

BiGHTY drilling screw  
Hardened stainless steel



### BiGHTY drilling screw

Bimetal

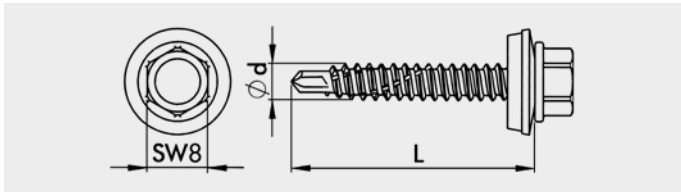

Art. no.	Dimensions [mm]	Spanner gap	Ø Seal ring [mm]	H [mm] <sup>a)</sup>	PU
Drilling capacity 3 mm					
945884	4,8 x 16	SW8	14	1	500
945885	4,8 x 19	SW8	14	4	500
945886	4,8 x 25	SW8	14	9	500
945887	4,8 x 32	SW8	14	16	500
945888	4,8 x 38	SW8	14	20	200
945847	4,8 x 50	SW8	14	32	200
Drilling capacity 5 mm					
945890	5,5 x 22	SW8	16	3	500
945891	5,5 x 25	SW8	16	7	500
945892	5,5 x 32	SW8	16	14	500
945893	5,5 x 38	SW8	16	20	500
945894	5,5 x 45	SW8	16	27	200
945875	5,5 x 50	SW8	16	32	200
945895	5,5 x 63	SW8	16	45	200
945896	6,3 x 25	SW10	16	7	500
945897	6,3 x 32	SW10	16	14	200
945898	6,3 x 38	SW10	16	20	200
945899	6,3 x 45	SW10	16	27	200
945841	6,3 x 50	SW10	16	32	200
945900	6,3 x 63	SW10	16	45	200
945901	6,3 x 70	SW10	16	52	200
945902	6,3 x 80	SW10	16	62	200
Drilling capacity 12 mm					
945844	5,5 x 38	SW8	16	10	500

a) H= Clamping thickness + Sheet thickness t; t<sub>max</sub> = Drilling capacity

### BiGHTY drilling screw

Bimetal

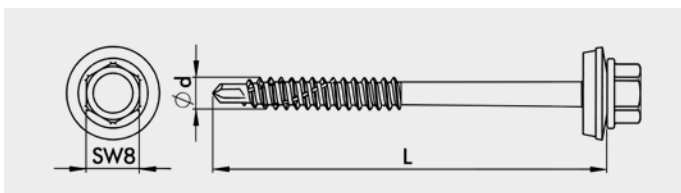

Art. no.	Dimensions [mm]	Spanner gap	Ø Seal ring [mm]	PU
Drilling capacity 5 mm				
945839	6,5 x 120	SW8	16	200
945915	6,5 x 140	SW8	16	200
945916	6,5 x 160	SW8	16	200
945917	6,5 x 180	SW8	16	200
945918	6,5 x 200	SW8	16	200
945919	6,5 x 220	SW8	16	200

### Schematic representation

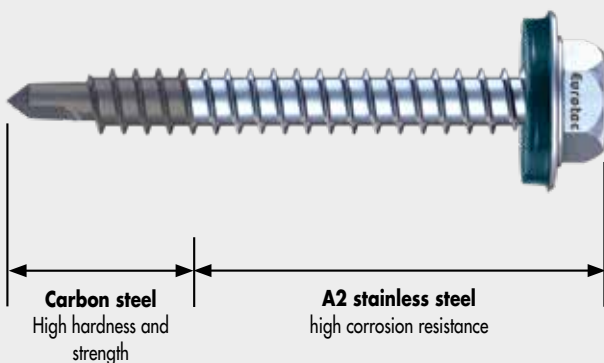

### Connection option

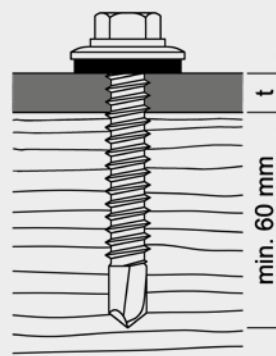

Steel on timber/timber on timber for BiGHTY bimetal 6,5 x L, drilling capacity 5 mm

Please always refer to the information in the ETA-12/0085

## BiGHTY drilling screw

Hardened stainless steel, specially coated

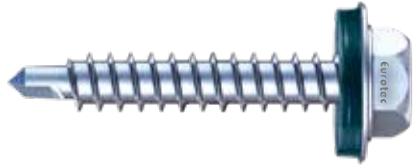

- Stainless steel in accordance with DIN 10088
- Seal ring in A2 and EPDM

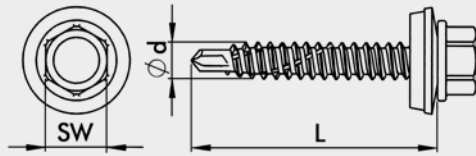

Art. no.	Dimensions [mm]	Spanner gap	Ø Seal ring [mm]	H [mm] <sup>a)</sup>	PU
Drilling capacity 3 mm					
945660	4,8 x 19	SW8	14	4	500
945661	4,8 x 25	SW8	14	10	500
945662	4,8 x 32	SW8	14	17	500
945663	4,8 x 38	SW8	14	23	200
945664	4,8 x 50	SW8	14	35	200
Drilling capacity 5 mm					
945665	5,5 x 19	SW8	16	2	500
945666	5,5 x 25	SW8	16	8	500
945667	5,5 x 32	SW8	16	15	500
945668	5,5 x 38	SW8	16	21	500
945669	5,5 x 50	SW8	16	33	200
945670	5,5 x 60	SW8	16	43	200
945672	6,3 x 25	SW10	16	8	500
945673	6,3 x 32	SW10	16	15	200
945674	6,3 x 38	SW10	16	21	200
945675	6,3 x 50	SW10	16	33	200
945676	6,3 x 60	SW10	16	43	200
Drilling capacity 12 mm					
945671	5,5 x 38	SW8	16	14	500

a) H= Clamping thickness + Sheet thickness t; t<sub>max</sub> = Drilling capacity



# Sandwich-panel screw, Roofing screw

## Sandwich-panel screw

Bimetal



- Specially coated
- Seal ring in A2 and EPDM
- Fastening steel on steel

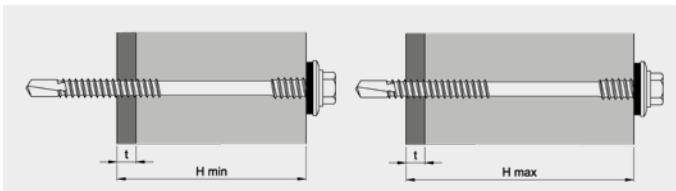
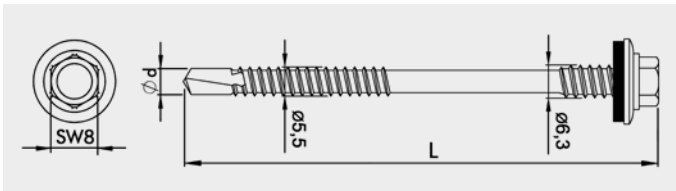

Art. no.	Dimensions [mm] <sup>a)</sup>	Spanner gap	Ø Seal ring [mm]	H <sub>min</sub> [mm] <sup>b)</sup>	H <sub>max</sub> [mm] <sup>b)</sup>	PU
Drilling capacity 5 mm						
945903	6,3/5,5 x 155	SW8	16	80	135	200
945904	6,3/5,5 x 175	SW8	16	100	155	200
945846	6,3/5,5 x 200	SW8	16	125	180	200
945905	6,3/5,5 x 235	SW8	16	160	215	200
945906	6,3/5,5 x 250	SW8	16	175	230	200
945907	6,3/5,5 x 275	SW8	16	200	255	200
945908	6,3/5,5 x 300	SW8	16	225	280	200
Drilling capacity 12 mm						
945909	6,3/5,5 x 155	SW8	16	75	130	200
945910	6,3/5,5 x 175	SW8	16	95	150	200
945845	6,3/5,5 x 200	SW8	16	120	175	200
945911	6,3/5,5 x 235	SW8	16	155	210	200
945912	6,3/5,5 x 250	SW8	16	170	225	200
945913	6,3/5,5 x 275	SW8	16	195	250	200
945914	6,3/5,5 x 300	SW8	16	220	275	200

a) Ø Head thread/Ø Drive thread x Screw length

b) H= Clamping thickness + Sheet thickness t; t<sub>max</sub> = Drilling capacity

## Roofing screw

Specially coated



- With hexagon head, secondary thread and drill point

### Fields of application

For flat-roof insulation (with anti-slip matting)

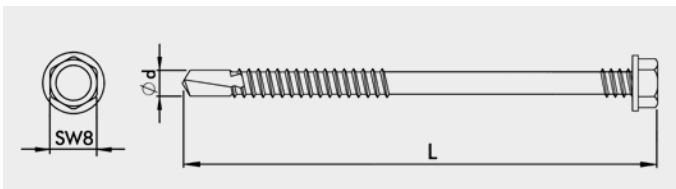

Art. no.	Dimensions [mm]	Spanner gap	PU*
900428	4,8 x 80	SW8	500
111377	4,8 x 100	SW8	500
111378	4,8 x 120	SW8	500
111379	4,8 x 140	SW8	500
111380	4,8 x 160	SW8	500
111381	4,8 x 180	SW8	500
111382	4,8 x 200	SW8	500
111383	4,8 x 220	SW8	500
111384	4,8 x 240	SW8	250
111385	4,8 x 260	SW8	250

\* Plates not included with product



# Bugle-head screw

## Bugle-head screw

Steel, special coated

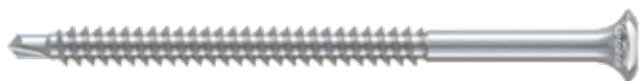

- With bugle-head and drill point

### Fields of application

For flat-roof insulation (with anti-slip matting)

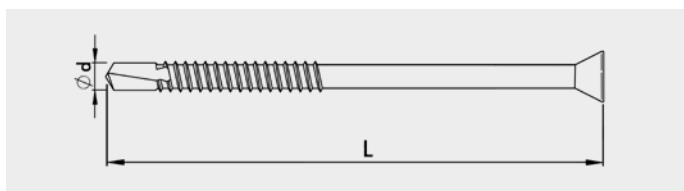

### For use on steel profile sheeting

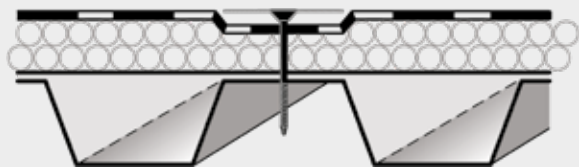

Art. no.	Dimensions [mm]	Drive	PU*
111303**	4,8 x 35	TX25 •	1000
111304**	4,8 x 50	TX25 •	1000
111305**	4,8 x 60	TX25 •	1000
111306	4,8 x 70	TX25 •	1000
111307**	4,8 x 80	TX25 •	500
111308**	4,8 x 90	TX25 •	500
111309**	4,8 x 100	TX25 •	500
111310**	4,8 x 110	TX25 •	500
111311**	4,8 x 120	TX25 •	500
111312**	4,8 x 130	TX25 •	500
111313**	4,8 x 140	TX25 •	500
111314**	4,8 x 150	TX25 •	500
111315**	4,8 x 160	TX25 •	500
111316**	4,8 x 170	TX25 •	500
111317**	4,8 x 180	TX25 •	500
111318**	4,8 x 200	TX25 •	500
111319**	4,8 x 220	TX25 •	500
111320**	4,8 x 240	TX25 •	500
111321**	4,8 x 260	TX25 •	500
111322**	4,8 x 280	TX25 •	250
111323**	4,8 x 300	TX25 •	250

\* Plates not included with product

\*\* On request



# Fibre cement screws

For fastening corrugated fibre cement sheets onto wooden substructures

## Fibre cement screw

Steel, special coated



Art. no.	Dimensions [mm]	Drive	PU
111353	6,5 x 130	SW8	100

### Fields of application

For fastening and sealing of corrugated fibre cement sheets

- Quick to screw in due to hex drive
- Pre-assembled mushroom seal seals the screw head from the top down

## Fibre cement screw A2

A2 stainless steel

Stainless Steel



Art. no.	Dimensions [mm]	Drive	PU
111356	6,5 x 130	SW8	100

### Fields of application

For fastening and sealing of corrugated fibre cement sheets

- Quick to screw in due to hex drive
- Pre-assembled mushroom seal seals the screw head from the top down

### A2 stainless steel

- Suitable for salty atmospheres under certain circumstances
- Acid-resistant under certain circumstances
- Not suitable for chlorinated atmospheres
- Can be used in service classes 1, 2 and 3
- Not suitable for woods containing high levels of tannin, such as cumarú, oak, merbau, robinia, etc.

### Instructions for use

To ensure the seal's durability (EPDM rubber) and therefore its protection against rain, the seal must not be pressed too forcefully against the corrugated sheet.

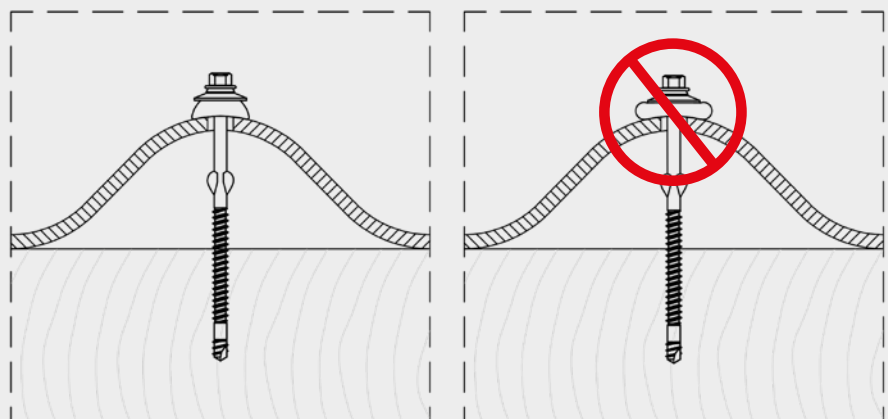

# Washed screw, Wall connecting bar

## Washed screw

A2 stainless steel, two-part with seal ring



Stainless Steel

### Fields of application

Interior construction; e. g. for (commercial) kitchens, cooling systems, etc.

Art. no.	Dimensions [mm]	Ø Seal ring [mm]	Drive	PU
111550	4,5 x 20	15	TX20	200
111551	4,5 x 25	15	TX20	500
111552	4,5 x 35	15	TX20	200
111553	4,5 x 45	15	TX20	200
111557	4,5 x 65	15	TX20	200
111558	4,5 x 80	15	TX20	200
111559	4,5 x 100	15	TX20	200
111560	4,5 x 120	15	TX20	200
111561	4,5 x 150	15	TX20	200

## Wall connecting bar



Art. no.	Dimensions [mm] <sup>a)</sup>	Ø Round hole [mm]	Material	PU
954197	60 x 12,4 x 3000	8	Aluminium	1

<sup>a)</sup> Height x width x length

Suitable for use with:  
Eurotec insulating  
stud anchor  
Art. no. 200036

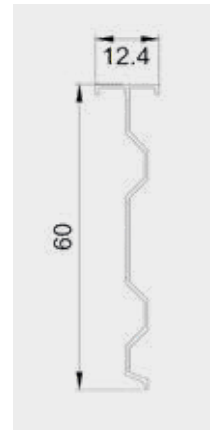

### Can be combined with:

- Eurotec insulating stud anchor
- Eurotec washed screw and EMD multi plug
- Eurotec sealing plug

The Eurotec wall connecting bar (sealing profile) made from extruded aluminium is used for professional finishing on roofs and façades. It is the connecting bar between the roof area and the vertical structural element and provides protection against rainwater.

The bar, which can be put to universal use, is suitable for many roof claddings and ensures a visually appealing finish.

### Advantages

- Quick and easy to install
- Pre-drilled fixing holes
- Weatherproof
- Can be put to universal use
- Can be combined with Eurotec fasteners

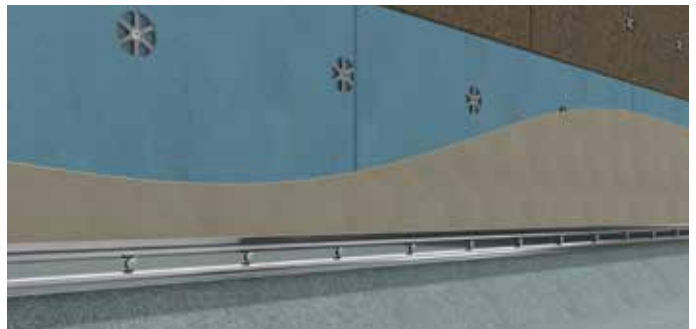



# Coloured façade screw

## Coloured façade screw

A2 and A4 stainless steel

**NEW  
dimensions**



Art. no.	Dimensions [mm]	Colour	Material	Drive	PU
<b>Stainless steel A2</b>					
904670	4,8 x 25	Blank	A2	TX20 ●	250
904671	4,8 x 32	Blank	A2	TX20 ●	250
904672	4,8 x 38	Blank	A2	TX20 ●	250
904675	4,8 x 60	Blank	A2	TX20 ●	250
W904670	4,8 x 25	White/RAL 9010	A2	TX20 ●	250
W904671	4,8 x 32	White/RAL 9010	A2	TX20 ●	250
W904672	4,8 x 38	White/RAL 9010	A2	TX20 ●	250
W904675	4,8 x 60	White/RAL 9010	A2	TX20 ●	250
G904670	4,8 x 25	Anthracite/RAL 7016	A2	TX20 ●	250
G904671	4,8 x 32	Anthracite/RAL 7016	A2	TX20 ●	250
G904672	4,8 x 38	Anthracite/RAL 7016	A2	TX20 ●	250
G904675	4,8 x 60	Anthracite/RAL 7016	A2	TX20 ●	250
<b>Stainless steel A4</b>					
900437*	5,3 x 25	Blank	A4	TX20 ●	100
900429	5,3 x 35	Blank	A4	TX20 ●	100
900442	5,3 x 45	Blank	A4	TX20 ●	100
900447	5,3 x 55	Blank	A4	TX20 ●	100
900452	5,3 x 65	Blank	A4	TX20 ●	100
900439*	5,3 x 25	White/RAL 9010	A4	TX20 ●	100
900431	5,3 x 35	White/RAL 9010	A4	TX20 ●	100
900444	5,3 x 45	White/RAL 9010	A4	TX20 ●	100
900449	5,3 x 55	White/RAL 9010	A4	TX20 ●	100
900454	5,3 x 65	White/RAL 9010	A4	TX20 ●	100
900441*	5,3 x 25	Anthracite/RAL 7016	A4	TX20 ●	100
900432	5,3 x 35	Anthracite/RAL 7016	A4	TX20 ●	100
900446	5,3 x 45	Anthracite/RAL 7016	A4	TX20 ●	100
900451	5,3 x 55	Anthracite/RAL 7016	A4	TX20 ●	100
900456	5,3 x 65	Anthracite/RAL 7016	A4	TX20 ●	100

\* Not regulated by ETA-11/0024.

 On request, screw heads can be painted in RAL Colours.



# Roof accessories

## Ridge batten holder 50

Galvanised steel



### Field of application

- As a support element for the ridge batten with an adjustable ridge batten holder height
- As a fastening element for installation of the ridge batten on sloping, ventilated roofs

### Advantages

- Rapid installation of the ridge batten
- Quick, problem-free and easy assembly
- Individual height adjustment
- It is characterised by a high level of durability

Art. no.	Dimensions [mm]	Dimension of the batten support [mm]	PU
954205	205 – 235	50	100

## Technical drawing

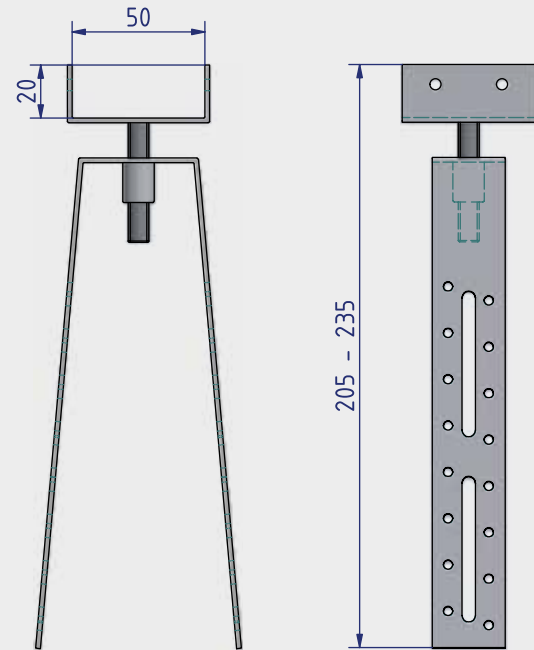

## Ridge screw

Galvanised steel, adjustable



### Field of application

- Used as a fixing element for ridge battens in ventilated pitched roofs

### Advantages

- Rapid installation of the ridge batten
- Quick, problem-free and easy assembly
- High level of ageing resistance
- Ensures that the ridge strip is correctly positioned
- Enables fast and reliable laying of the ridge tiles on the ridge strip
- The screw enables quick and precise assembly

Art. no.	Dimensions [mm]	Dimension of the batten support [mm]	Drive	PU
954206	7 x 180	50	TX40	100

## Technical drawing

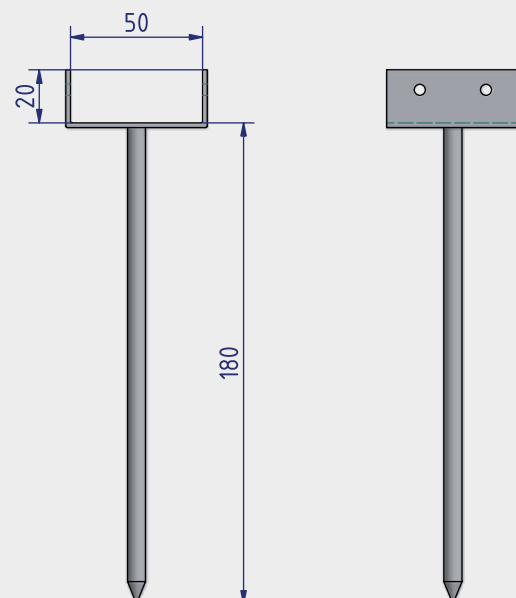



## Bird control spikes

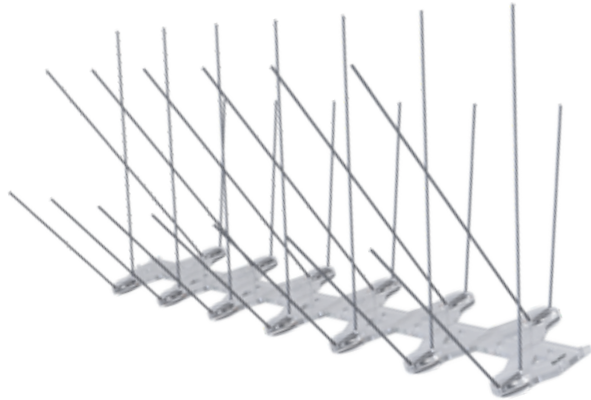

### Field of application

- Protect roofs, window sills and other surfaces of buildings as well as façades from birds

### Advantages

- Quick and easy assembly
- Connection of several modules
- Resistant to UV radiation

Art. no.	Dimensions [mm] <sup>a)</sup>	Material	PU
954207	110 x 335 x 60	Polycarbonate, galvanised steel	15

a) Height x length x width

## Roof venting hose



### Field of application

- The venting hose is used in pitched roofs to connect the roof hatches with the attic

### Advantages / Properties

- Quick and easy assembly
- Resistant to UV radiation
- Large ventilation area
- Ensures effective transport of moisture from the attic
- Proper ventilation of attics, kitchens and bathrooms
- The flexible structure allows adjustment of the duct's angle and installation of the pipe reducer

Art. no.	Dimensions [mm]	Length [cm]	Material	PU
954208	Ø 110/70	60	Polymer	10
954209	Ø 150/150	105	Polymer	6

## Downpipe hose



### Application

- Is used as a downpipe replacement for rainwater drainage
- It is attached using adhesive tape or cable ties

### Advantages

- Discharges rainwater in a controlled and safe manner
- Can be quickly and easily attached and removed
- Optimal interim solution for imminent construction work
- No soiling and damage to the façade

Art. no.	Dimensions [mm]	Weight [g]	PU
954196	Ø 0,2 x 100	2000	1

Art. no.	Dimensions [m]*	PU
954196	Ø 0,13 / 0,20 x 100	1

\* Downpipe hose / Role x lenght



## Ridge end disc

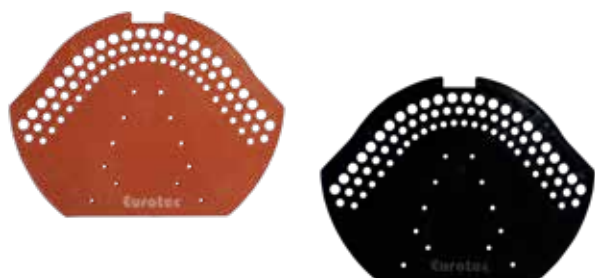

Art. no.	Dimensions [mm] <sup>a)</sup>	Colour	Material	PU
954210	50 x 120	Red	Polymer	25
954211	50 x 120	Black	Polymer	25

a) Length x width

### Field of application

- For closing the roof ridge
- Universal shapes allow use with most roof tiles available on the market

### Advantages

- Quick and easy assembly
- Weatherproof
- Good strength
- It ensures good air circulation in the ridge area and prevents leaves and insects from penetrating

## Eaves ventilation element

Black

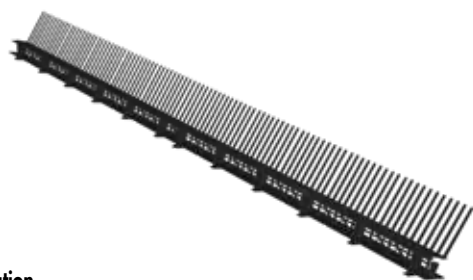

Art. no.	Dimensions [mm] <sup>a)</sup>	Material	PU
954212	85 x 1000	Polymer	50

a) Height x length

### Field of application

- Protect the eaves from birds, rodents and large insects
- Provides good ventilation and air circulation in the eaves area by preventing the leaves stirred up by the wind from penetrating

### Advantages

- Quick and easy assembly
- Weatherproof
- Good strength
- Enables quicker and easier assembly of the gutter hooks
- An additional ventilation grate replaces the eaves batten

## Roller ridge



Art. no.	Dimensions [mm] <sup>a)</sup>	Colour	Material	PU
954221	5000 x 320	Black (RAL 9005)	PP fleece	1
954222	5000 x 320	Red (RAL 8004)	PP fleece	1

a) Length x width

The roll ridge is made of high-quality, diffusible PP fleece (150 g) and pleated aluminium sheet. Thanks to the fleece, the tape enables ventilation between the eaves and the ridge. All without any risk of water or rodents getting underneath the roof structure.

### Advantages

- Elastic and resistant adhesive
- Effective ventilation between eaves and ridge
- Weather resistance

## Bird screen/Ventilation profile



### Application

- To safeguard the ventilation openings on building façades and in the eaves area of ventilated roofs against birds, rodents and insects
- Provides protection against leaves and other dirt
- Ensures proper ventilation and air circulation in the façade and roof areas

### Advantages

- Provides a solution for protection from leaves and other contaminants
- Resistant to UV radiation
- Suitable for all roof types

Art. no.	Dimensions [mm] <sup>a)</sup>	Colour	Material	PU
954214	5000 x 100	White	Polymer	24
954216	5000 x 80	Black	Polymer	24
954217	5000 x 100	Black	Polymer	24
954218	5000 x 150	Black	Polymer	24

a) Length x width

## Wall and fireplace connection



The self-adhesive wall and fireplace connection provides a simple, secure roof connection. The lead-free strip is made of a structured aluminium sheet and dyed with polyester paint. Not only can the product be used for sealing between the wall or fireplace and roof surface, but it's also ideal for weatherproofing around chimneys, exterior walls and roof windows. The universal product, dyed with polyester paint, is available in two colours: brick red and black.

### Advantages

- Self-adhesive wall connection tape
- Easy to shape and to install
- Weather resistance, colour stability and UV resistance

Art. no.	Dimensions [mm] <sup>a)</sup>	Colour	Material	PU
954219	5000 x 300	Black (RAL 9005)	Aluminium	1
954220	5000 x 300	Red (RAL 8004)	Aluminium	1

a) Length x width

## Uni-Tape



### Advantages

- Stretchable
- Very flexible
- High resistance to ageing
- Permanent moisture resistance (GPM 812)
- Reinforcement prevents over stretching

### Description

Eurotec Uni Tape is a polyethylene bonding tape with a high-strength, moisture-resistant polyacrylate adhesive with excellent ageing resistance. Designed for interior airtight bonding and sealing of vapour barrier and air-tight membrane overlaps and penetrations in accordance with DIN 4108-7. Uni Tape is also suitable for bonding polypropylene fleece material, aluminium sheeting, MDF and plywood panels as well as plastics.

Art. no.	Dimensions [mm] <sup>a)</sup>	Colour	PU
954202	60 x 25000	Black	10

a) Width x length

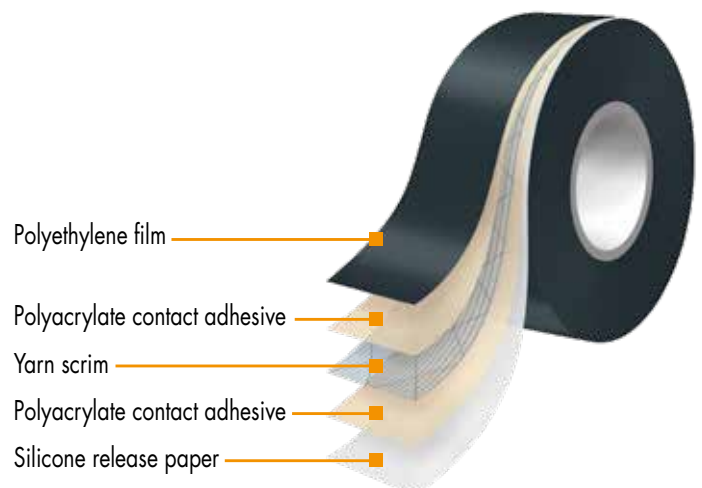

# EiSYS

Façade/adjusting screw



## What can they be used for?

- For use with suspended façades
- For rear-ventilated façades if the outer wall is designed with timber formwork, fibre cement boards or other façade elements

## Properties

- This screw is fastened to the building wall with a plug
- The freely rotating threaded sleeve at the top of the screw allows the façade's substructure to be aligned parallel to the building wall

## Advantages

- Cost savings and reduced assembly times
- High loads can be transmitted through the framework screw connections even in the case of larger distances from the building wall
- Full design freedom is maintained for the façade

For additional information,  
please take a look at our façade brochure

[www.eurotec.team/en/catalogues](http://www.eurotec.team/en/catalogues)



© alexandra zeiger - stock.adobe.com



EiSYS-Aluminium



EiSYS dowel



EiSYS-Aluminium  
Façade profile



## EiSYS-Aluminium

Façade/adjusting screw for aluminium, hardened stainless steel A4



Art. no.	Dimensions [mm]	For insulation thicknesses up to [mm]	PU
946213	7,0 x 165	40	50
946214	7,0 x 185	60	50
946215	7,0 x 205	80	50
946216	7,0 x 225	100	50
946217	7,0 x 245	120	50
946218	7,0 x 265	140	50
946219	7,0 x 285	160	50
946220	7,0 x 305	180	50
946221	7,0 x 325	200	50
946222	7,0 x 345	220	50
946223	7,0 x 365	240	50
946224	7,0 x 385	260	50
946225	7,0 x 405	280	50
946226	7,0 x 425	300	25

Note: Table for selecting EiSYS-Aluminium screws with the façade profile 102 x 50 x 2 mm

## EiSYS dowels

EiSYS-Aluminium and -Timber



## EiSYS-Aluminium

Drilling screw, Nut, Washer, Taper washer

On request



Art. no.	Dimensions [mm]	PU
945405	10,0 x 80	50

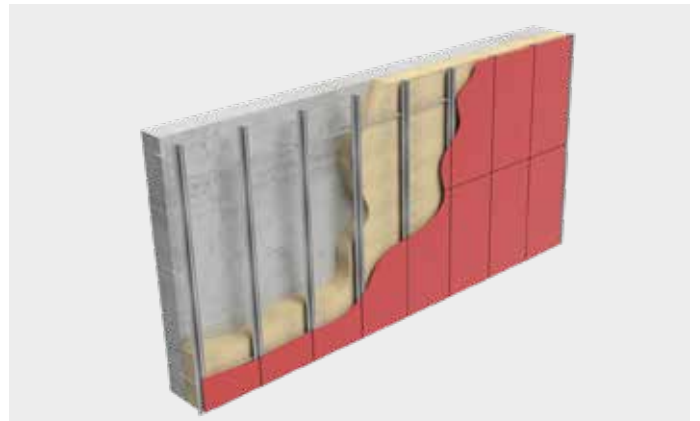

## EiSYS-Aluminium façade profile



Art. no.	Dimensions [mm]	PU
On request	50 x 102 x 3000	1

## EiSYS-Aluminium L-Profil



Art. no.	Dimensions [mm]	PU
On request	35 x 35 x 2 x 6000	1

## EiSYS-Aluminium insertion tool



Art. no.	Dimensions	Drive	PU
945416*	10 x 80	Internal hex - SW5,4 External hex - SW10	1

\* Discontinued item

## EiSYS-Timber

Façade/adjusting screw for timber, A4 stainless steel

**Stainless Steel**



Art. no.	Dimensions [mm]	For insulation thicknesses up to [mm]	PU
946080	7,0 x 198	60	50
946081	7,0 x 218	80	50
946082	7,0 x 238	100	50
946083	7,0 x 258	120	50
946084	7,0 x 278	140	50
946085	7,0 x 298	160	50
946086	7,0 x 318	180	50
946087	7,0 x 338	200	50
946088	7,0 x 358	220	50
946089	7,0 x 378	240	50
946090	7,0 x 398	260	50
946091	7,0 x 418	280	50
946092	7,0 x 438	300	50

## EiSYS-Timber insertion tool



Art. no.	Dimensions [mm]	Drive	PU
946096	70 x 14	SW12 / TX30	1

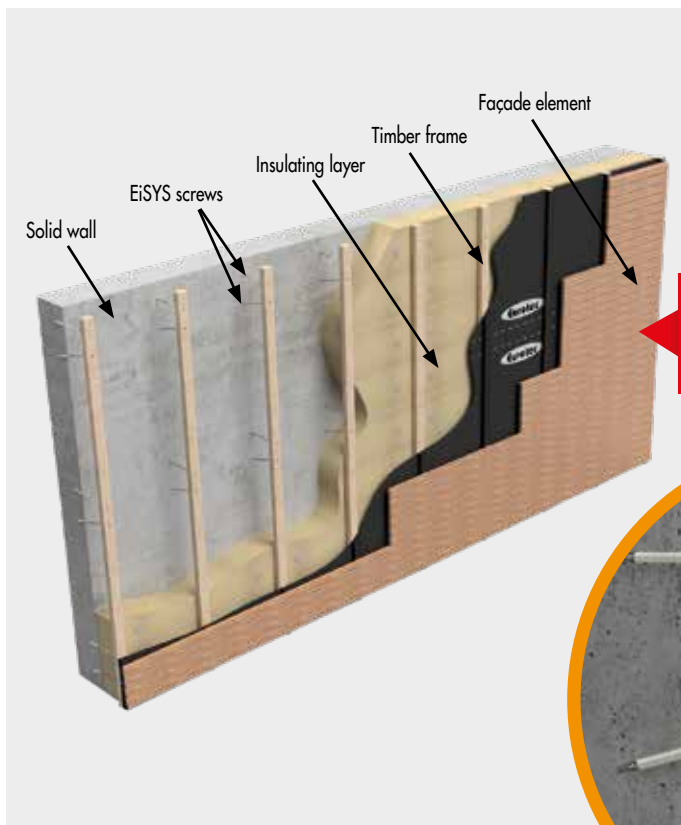

**Example application:**  
The V-shaped arrangement of the EiSYS-2 screw pair achieves optimum stability and load capacity of the façade construction.



## EiSYS-Timber Façade/adjusting screw for timber

This screw is used to fasten façades in place. Insulation thicknesses of 60 – 300 mm can be handled easily with the EiSYS-Timber screw from Eurotec.

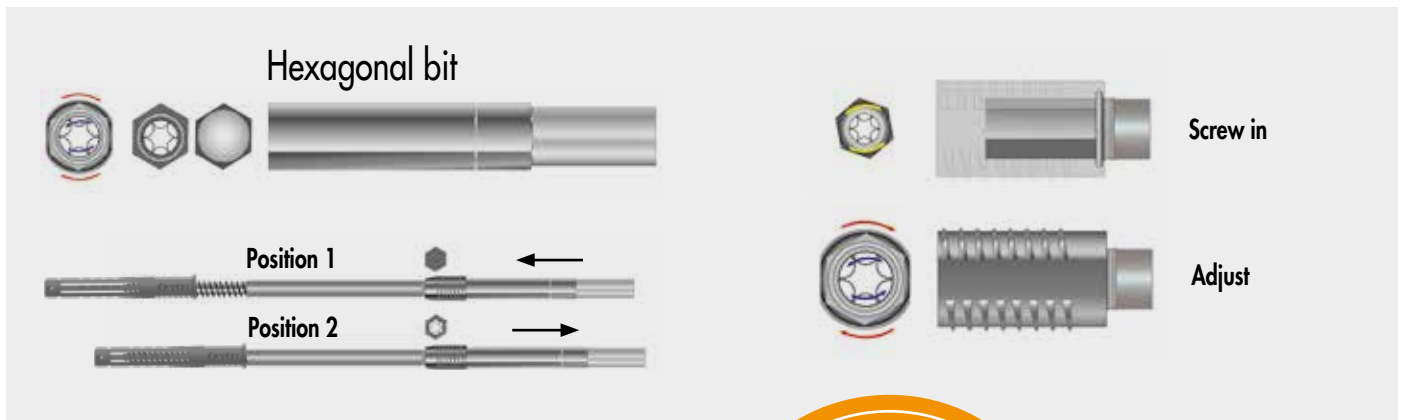

The EiSYS-Timber screw is fitted with a freely rotating adjustment sleeve/ head that allows the space between the brickwork and the substructure to be tailored to your needs. A hexagonal bit is supplied as an accessory. This is used to screw the screw into the subsurface, as well as to adjust the substructure with the adjustment head.



### This is how it's done!

The principle is as ingenious as it is simple. Once the insulation is attached to the exterior wall, the counter batten is pilot-drilled to a diameter of 16 mm in accordance with the system. A hole of 10 mm diameter is then drilled within this hole through the insulation and into the subsurface to create the hole for the plug. The plug is attached to the adjusting screw and the two are then inserted into the

prepared drill hole through the counter batten and the insulation. The EiSYS-Timber façade/adjusting screw is screwed in completely in position 1 using the hexagonal bit until the adjustment head also lies within the counter batten. Now, the screw is simply pulled out to position 2 using the hexagonal bit and the spacing between the brickwork and the counter batten is adjusted.

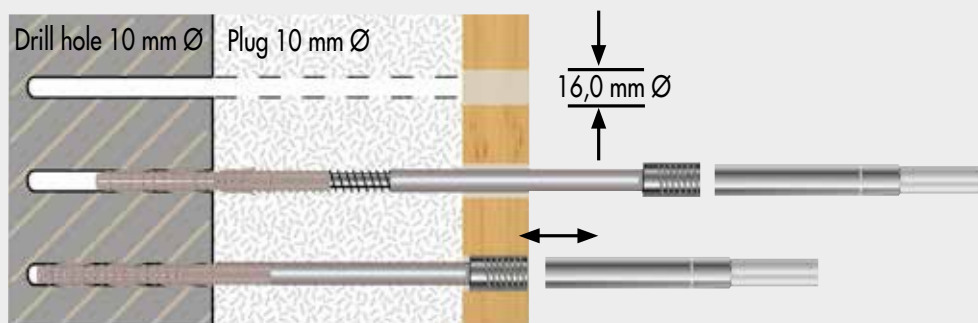

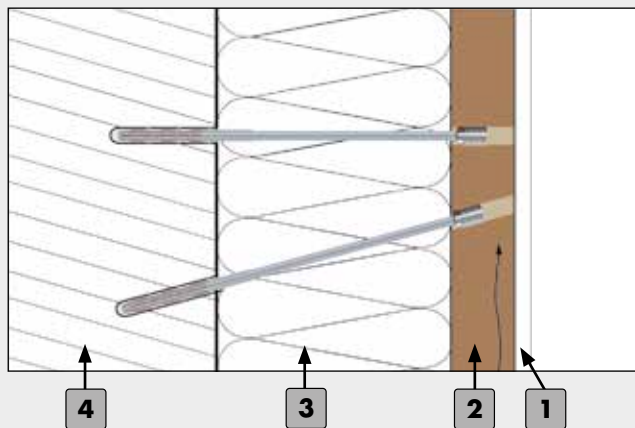

## Example of a rear-ventilated façade (EiSYS-Timber system diagram)

- 1** Façade element
- 2** Timber frame (mind. 40 x 60 mm<sup>2</sup>)
- 3** Insulating layer
- 4** Brickwork (EiSYS fixing depth = 90 mm)

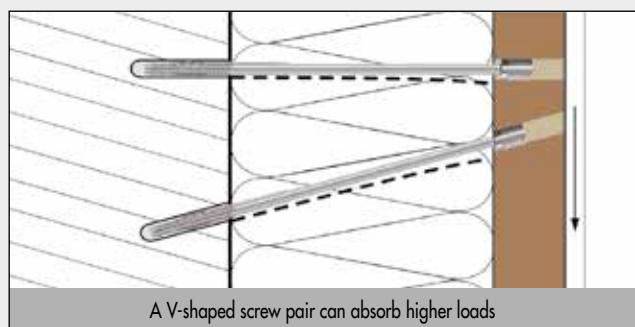
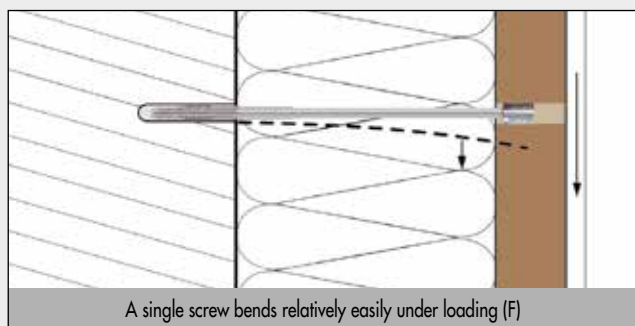

To increase the rigidity of the EiSYS-Timber system, the adjusting screws are installed in pairs and in a V shape. This creates a framework screw connection. The framework principle consists of creating a large number of rigid triangles (see diagram) from multiple relatively pliable screws installed perpendicular to the wall. For the same load, these triangles exhibit a much lower deflection than screws that are simply screwed in perpendicular to the wall.

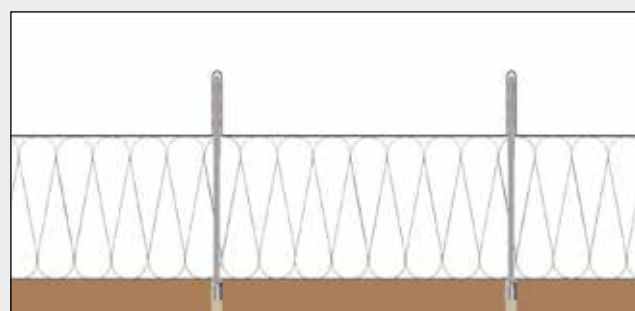

## Example of a suspended ceiling

The EiSYS-Timber's adjustment function can, of course, also be used in other applications, e. g. for a suspended ceiling.



## EiSYS-2

Façade/adjusting screw



### Example application:

The V-shaped arrangement of the EiSYS-2 screw pair achieves optimum stability and load capacity of the façade construction.

Art. no.	Dimensions [mm]	For insulation thicknesses up to [mm] <sup>a)</sup>	PU
945935	7,2 x 198	60	50
945925	7,2 x 218	80	50
945926	7,2 x 238	100	50
945927	7,2 x 258	120	50
945928	7,2 x 278	140	50
945929	7,2 x 298	160	50
945474	7,2 x 318	180	50
945930	7,2 x 338	200	50
945931	7,2 x 358	220	50
945932	7,2 x 378	240	50
945933	7,2 x 398	260	50
945934	7,2 x 418	280	50

a) And for a counter-batten thickness of 40 mm

## Plug

For EiSYS-2 screws



Art. no.	Dimensions [mm]	Type	PU
945404	10,0 x 130	B 10 H	200

## Manual adjustment tool



Art. no.	Dimensions [mm]	PU
111828	10,0 x 150/115	1

## Bit

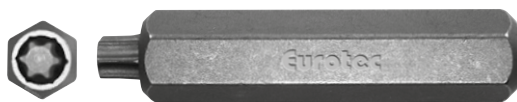

Art. no.	Dimensions [mm]	Drive	PU
945936	10,0 x 50	TX30 •	1

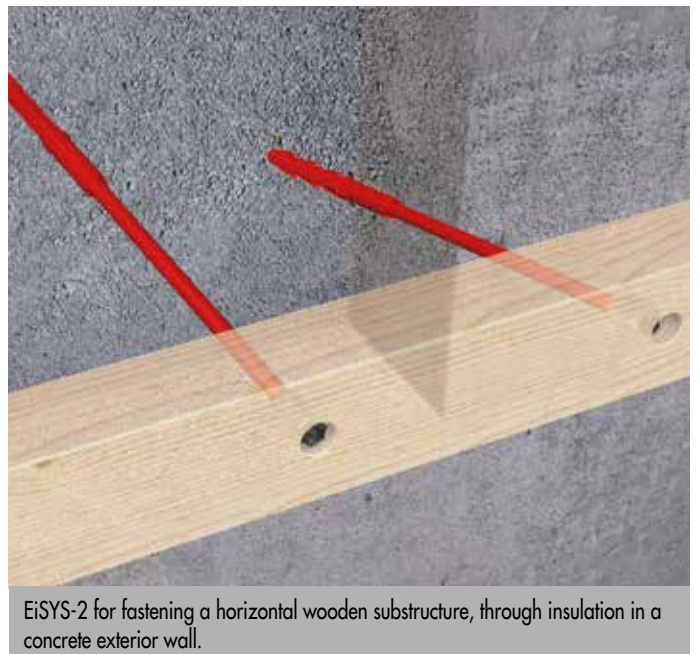
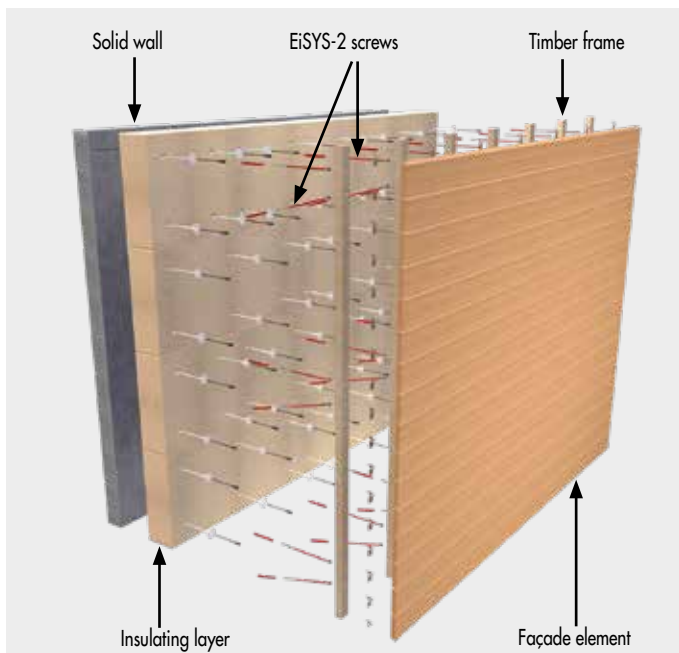

EiSYS-2 for fastening a horizontal wooden substructure, through insulation in a concrete exterior wall.

Calculating the number of EiSYS-2 screw pairs per m<sup>2</sup> - counter batten 40 x 60 mm<sup>2</sup>  
EiSYS-2 screws are always used in pairs. See system diagram.

Wind pressure k= 0,30 kN/m <sup>2</sup>							
Insulating-material thickness [mm]	EiSYS-2 Screw	Unladen weight of the façade					
		5 kg/m <sup>2</sup>	10 kg/m <sup>2</sup>	15 kg/m <sup>2</sup>	20 kg/m <sup>2</sup>	25 kg/m <sup>2</sup>	30 kg/m <sup>2</sup>
80	7,2 x 218	0,45	0,8	1,26	1,67	2,08	2,48
100	7,2 x 238	0,54	1,04	1,54	2,04	2,54	3,04
120	7,2 x 258	0,64	1,23	1,82	2,42	3,01	3,60
140	7,2 x 278	0,73	1,42	2,10	2,79	3,48	4,16
160	7,2 x 298	0,82	1,60	2,38	3,16	3,94	4,72
180	7,2 x 318	0,92	1,79	2,66	3,54	4,41	5,28
200	7,2 x 338	1,01	1,98	2,94	3,91	4,88	5,84
220	7,2 x 358	1,11	2,17	3,23	4,29	5,35	6,41

Wind pressure k= 0,60 kN/m <sup>2</sup>							
80	7,2 x 218	0,75	0,90	1,31	1,72	2,12	2,53
100	7,2 x 238	0,75	1,09	1,59	2,09	2,59	3,09
120	7,2 x 258	0,75	1,28	1,87	2,46	3,06	3,65
140	7,2 x 278	0,78	1,46	2,15	2,84	3,52	4,21
160	7,2 x 298	0,87	1,65	2,43	3,21	3,99	4,77
180	7,2 x 318	0,96	1,84	2,71	3,58	4,46	5,33
200	7,2 x 338	1,06	2,02	2,99	3,96	4,92	5,89
220	7,2 x 358	1,15	2,21	3,27	4,33	5,39	6,45

Wind pressure k= 0,90 kN/m <sup>2</sup>							
80	7,2 x 218	1,13	1,13	1,35	1,76	2,17	2,57
100	7,2 x 238	1,13	1,13	1,63	2,13	2,63	3,13
120	7,2 x 258	1,13	1,32	1,91	2,51	3,10	3,69
140	7,2 x 278	1,13	1,51	2,19	2,88	3,57	4,25
160	7,2 x 298	1,13	1,69	2,47	3,25	4,03	4,81
180	7,2 x 318	1,13	1,88	2,75	3,63	4,50	5,37
200	7,2 x 338	1,13	2,07	3,03	4,00	4,97	5,93
220	7,2 x 358	1,20	2,26	3,32	4,38	5,44	6,50

Wind pressure k= 1,20 kN/m <sup>2</sup>							
80	7,2 x 218	1,50	1,50	1,50	1,81	2,21	2,62
100	7,2 x 238	1,50	1,50	1,68	2,18	2,68	3,18
120	7,2 x 258	1,50	1,50	1,96	2,55	3,15	3,74
140	7,2 x 278	1,50	1,55	2,24	2,93	3,61	4,30
160	7,2 x 298	1,50	1,74	2,52	3,30	4,08	4,86
180	7,2 x 318	1,50	1,93	2,80	3,67	4,55	5,42
200	7,2 x 338	1,50	2,11	3,08	4,05	5,01	5,98
220	7,2 x 358	1,50	2,30	3,36	4,42	5,48	6,54

Please note: The stated values are planning aids. Projects must only be calculated by authorised persons.





# Blue-Power façade mounting system

For fastening timber substructures to concrete or brickwork



## What can they be used for?

- For façade fastenings where wooden sub-structures are to be fixed on concrete or masonry at a distance
- Outdoors: rear-ventilated curtain façade with façade insulation
- Indoors: e. g. suspended ceilings, wall panelling etc.

## Properties

- Absorbs the possible load consisting of tensile and shear forces

## Advantages

- Quick and easy solution
- Plug-free installation
- Short assembly times
- Can be used with standard battery-driven electric tools

For additional information,  
please take a look at our façade brochure

[www.eurotec.team/en/catalogues](http://www.eurotec.team/en/catalogues)





## Blue-Power system screw

Countersunk-head, special coated



### Advantages

- Plug-free installation
- Short assembly times
- Can be used with standard battery-driven electric tools

### Areas of use

Outdoors: rear-ventilated curtain façade with façade insulation  
Indoors: e. g. suspended ceilings, wall panelling, etc.

## Assembly

- 1 Pre-drill the battens to 6,5 mm
- 2 Pre-drill the substrate
- 3 Insert the Blue-Power system screw through the battens and into the substrate

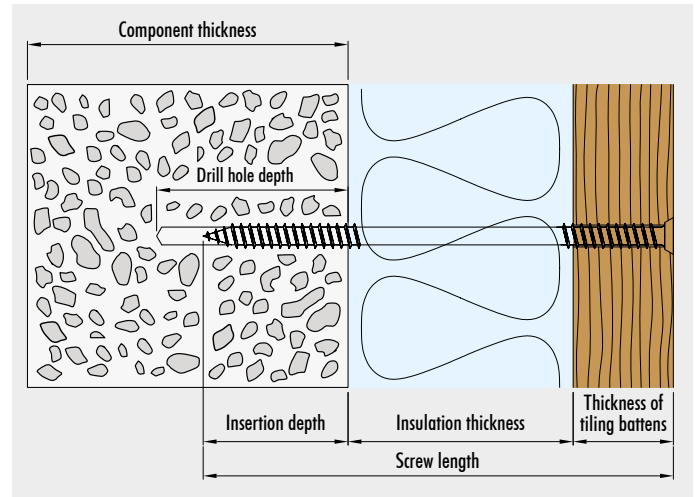

Art. no.	Dimensions [mm]	Drive	For insulation thicknesses up to <sup>a)</sup>			PU
			Concrete, clay brick and solid lime sand brick [mm] <sup>a)</sup>	Porous concrete and perforated lime sand brick [mm] <sup>a)</sup>	Vertically perforated brick [mm] <sup>a)</sup>	
110390	7,4 x 180	TX40 ●	100	80	30	100
110391	7,4 x 200	TX40 ●	120	100	50	100
110392	7,4 x 220	TX40 ●	140	120	70	100
110393	7,4 x 240	TX40 ●	160	140	90	100
110394	7,4 x 260	TX40 ●	180	160	110	100
110395	7,4 x 280	TX40 ●	200	180	130	100
110396	7,4 x 300	TX40 ●	220	200	150	100
110397	7,4 x 320	TX40 ●	240	220	170	100
110398	7,4 x 340	TX40 ●	260	240	190	100
110399	7,4 x 360	TX40 ●	280	260	210	100
110400	7,4 x 380	TX40 ●	300	280	230	100
110401	7,4 x 400	TX40 ●	320	300	250	100
110404	7,4 x 450	TX40 ●	340	320	270	100
110407	7,4 x 500	TX40 ●	360	340	290	100

a) For a tiling batten thickness of 30 mm

Screw length  $\geq$  min. Insertion depth + Insulation thickness + Tiling batten thickness



## Static values

Subsurface	Substrate drilling Ø [mm]	Drill Ø in subsurface [mm]	min. Screw embedment depth [mm]	Drilling method <sup>a)</sup>	min. Component thickness [mm]	min. Edge distance [mm]	min. Axial distance [mm]	Char. tensile capacity $N_{Rk}$ <sup>b)</sup> [kN]	Char. shear load-bearing capacity $V_{Rk}$ [kN]
Concrete C20/25	6,0	70	50	H	100	50	100	2,5	0,75
Clay brick (CB)	6,0	70	50	H	115	50	100	3,5	0,6
Solid sand-lime brick	6,0	70	50	H	115	50	100	3,5	0,5
Porous concrete	5,0	85	70	R	115	50	100	0,9	0,3
Perforated lime sand brick	5,0	85	70	R	115	50	100	2,0	0,6
Vertically perforated brick (VPB)	6,5	140	120	R	175	50	100	0,5	0,4
Timber	c)	c)	50	R	60	25	100	d)	d)

a) H = Hammer drilling, D = Rotary drilling

b) The characteristic head pull-through capacity  $F_{ex,head,Rd}$  in the battens must be taken into account.  $F_{ex,head,Rd}(\rho_k > 350) = 1,45$  kN. The battens must be pre-drilled to 6,5 mm.

c) Pilot-drilling on a wooden surface is not required.

d) Has to be calculated according to EN 1995-1-1:2010-12.

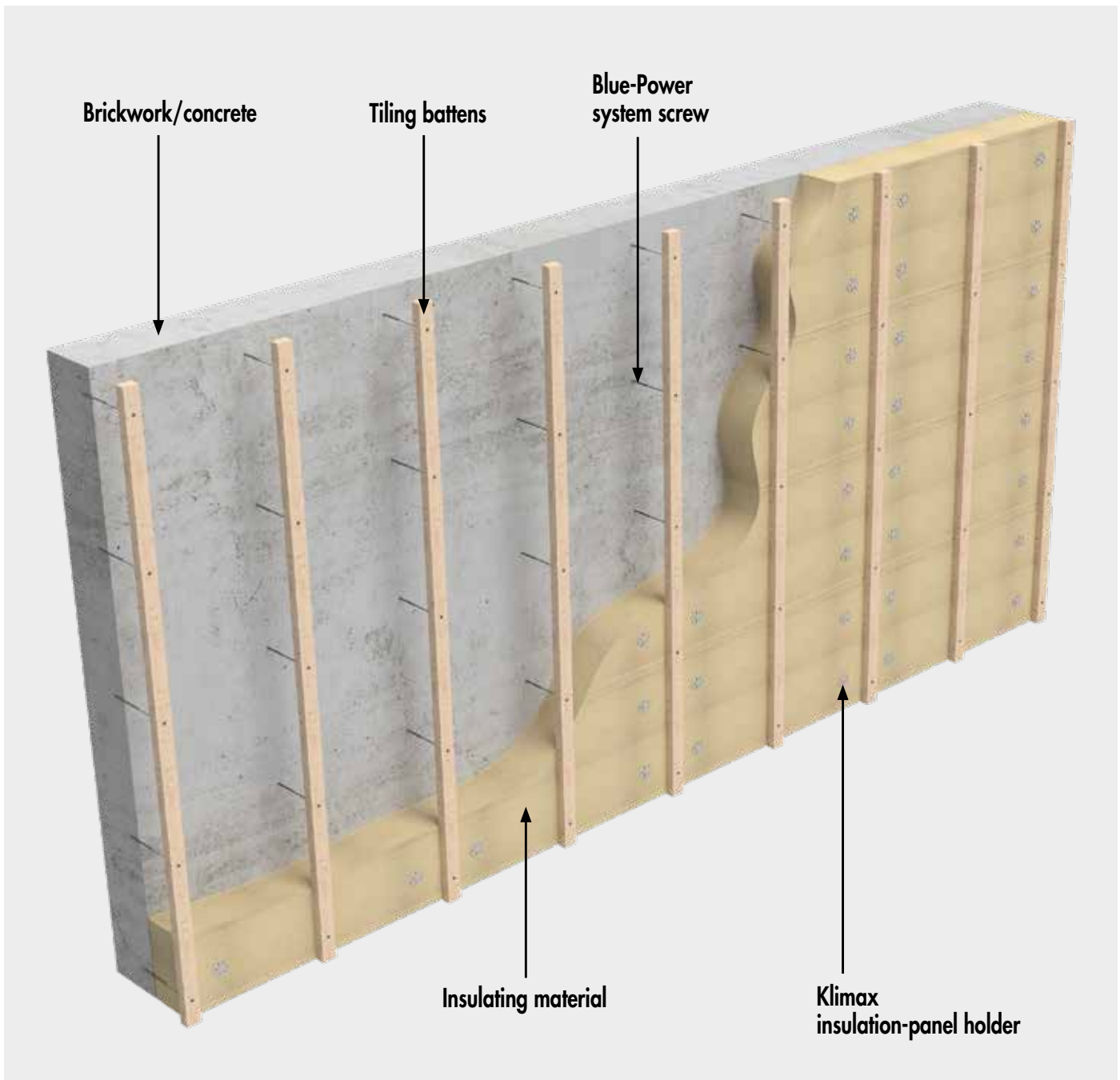

**NEW**  
to our product range

# CoverFix façade guide rail

For non-visible fastening of façade woods

## CoverFix façade guide rail



### Advantages

- Invisible attachment points
- Ideal for constructive wood protection
- Ventilated façade system with distance mounting
- Façade wood remains undamaged in weather conditions
- Simple and efficient assembly

### Assembly

1. Cut the CoverFix façade guide rail to the desired length.
2. Place the CoverFix façade guide rail on the back of the façade wood and insert mounting screws.
3. Repeat the process on every further façade wood element in an offset manner.
4. Fasten the façade wood element to the counter batten with fixing screws.
5. Fix the next façade wood element, observing the distance between the individual elements. Finished!

Art. no.	Material	Dimensions [mm] <sup>a)</sup>	PU
975672	Aluminium, black	800 x 20 x 8	1

a) Length x width x height



# Klimax insulation-panel holder, Klimax insulation plug, Klimax ECO 1/ECO 2

## Klimax

Insulation-panel holder



- Ideal fastening of wood-fibre insulation elements
- For soft insulating materials

## Klimax-slim

Insulation-panel holder



- Ideal fastening of wood-fibre insulation elements
- For harder insulating materials

## Paneltwistec AG

Countersunk head, blue galvanised steel

**Suitable  
for this**



Art. no.	Dimensions [mm]	PU
945251	Ø 60	400

Art. no.	Dimensions [mm]	PU
945987	Ø 60	900

Art. no.	Dimensions [mm]	Drive	PU
945583	6,0 x 60	TX30 ●	200
945584	6,0 x 70	TX30 ●	200
945632	6,0 x 80	TX30 ●	200
945633	6,0 x 90	TX30 ●	100
945634	6,0 x 100	TX30 ●	100
945636	6,0 x 120	TX30 ●	100
945637	6,0 x 130	TX30 ●	100
945638	6,0 x 140	TX30 ●	100
945640	6,0 x 160	TX30 ●	100
945641	6,0 x 180	TX30 ●	100
945642	6,0 x 200	TX30 ●	100
945643	6,0 x 220	TX30 ●	100
945644	6,0 x 240	TX30 ●	100
945645	6,0 x 260	TX30 ●	100
945646	6,0 x 280	TX30 ●	100
945647	6,0 x 300	TX30 ●	100

### Energy-saving measures are becoming increasingly important in the construction of new houses and also enjoy state support!

Decoupling the individual fastening components avoids the creation of thermal bridges. Good insulation results in an extraordinarily comfortable environment. The Klimax insulation-panel holder, in conjunction with the Paneltwistec screws from Eurotec, offers an ideal combination for fastening wood-fibre insulation elements. The prerequisite for this is a load-bearing timber substructure.



## Klimax

Insulation plug



- For fastening composite thermal insulation systems



### Advantages

- Fast and efficient assembly
- Universally suitable for numerous insulating materials and subsurfaces
- Flat plug head

### Installation parameters

- Nominal drill diameter: 8,00 mm
- Depth of drill hole to lowest point: 40,00 mm
- Effective anchorage depth: 30,00 mm

Art. no.	Dimensions [mm]	Plate Ø [mm]	Insulation thickness [mm]	PU
200027	8,0 x 90	60	40 - 60	250
200028	8,0 x 110	60	80	250
200029	8,0 x 130	60	100	200
200030	8,0 x 150	60	120	150
200031	8,0 x 170	60	140	150
200032	8,0 x 190	60	160	100
200033	8,0 x 210	60	180	100
200034	8,0 x 240	60	210	100

## Assembly instructions

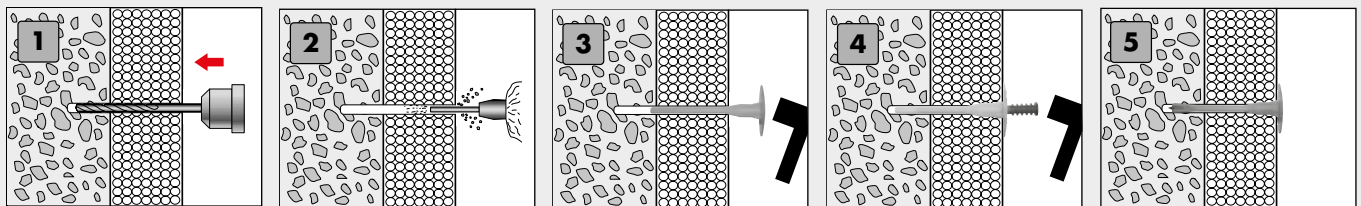

## Klimax ECO 1

Insulation plug, one-piece



- For secure fastening of soft mineral-fibre insulating materials
- With a hole in the head to accommodate a mesh fabric holder
- For insulating material thickness 30 – 140 mm

Art. no.	Dimensions [mm]	Plate Ø [mm]	Insulation thickness [mm]	PU
200065	Ø 8,0 x 60	90	30 - 40	250
200066	Ø 8,0 x 80	90	50 - 60	250
200067	Ø 8,0 x 100	90	70 - 80	250
200068	Ø 8,0 x 120	90	90 - 100	250
200069	Ø 8,0 x 140	90	110 - 120	200
200070	Ø 8,0 x 160	90	130 - 140	200

## Klimax ECO 2

Insulation plug, two-piece



- For secure fastening of soft mineral-fibre insulating materials
- For insulating material thickness of 30 – 210 mm

Art. no.	Dimensions [mm]	Plate Ø [mm]	Insulation thickness [mm]	PU
200071	Ø 8,0 x 80	90	30 - 50	250
200072	Ø 8,0 x 100	90	60 - 70	250
200073	Ø 8,0 x 120	90	80 - 90	250
200074	Ø 8,0 x 140	90	100 - 110	250
200075	Ø 8,0 x 160	90	120 - 130	250
200076	Ø 8,0 x 180	90	140 - 150	250
200077	Ø 8,0 x 200	90	160 - 170	250
200078	Ø 8,0 x 220	90	180 - 190	250
200079	Ø 8,0 x 240	90	200 - 210	250

### Advantages

- No thermal bridges
- Time-saving and straightforward impact installation
- Impact-resistant plastic
- Particularly suitable for use with rear-ventilated curtain facades
- Temperature-resistant from -40 °C to +70 °C

### Installation parameters

- Nominal drill diameter: ECO 1 = 8,0 mm, ECO 2 = 8,0 mm
- Minimum drill-hole depth: ECO 1 = 25,0 mm, ECO 2 = 35,0 mm
- Minimum installation depth: ECO 1 = 20,0 mm, ECO 2 = 30,0 mm



# Index

<b>A</b>	A new era of wood connectors . . . . .	231 - 234	Decking multi angles . . . . .	94	
	Adapter for BASE-Line . . . . .	43	Deep hole marker <b>NEW</b> . . . . .	379	
	for Profi-Line . . . . .	47	DiLo aluminium function strip . . . . .	74	
	for Quattro Lager . . . . .	49	DiLo drilling screw . . . . .	75	
	for SL BASE <b>NEW</b> . . . . .	45	Distance strip 2.0 . . . . .	104 - 105	
	Adjustable pedestal SL BASE <b>NEW</b> . . . . .	44 - 45	Dowel bar . . . . .	259	
	Adjustable pedestals . . . . .	14 - 15, 40 - 48	Downpipe hose . . . . .	423	
	Adjustment blocks . . . . .	383 - 385	DrainTec - drainage grate . . . . .	85	
	Aluminium concrete bracket . . . . .	68	DrainTec Adapter <b>NEW</b> . . . . .	87	
	Aluminium cover . . . . .	82	DrainTec Base . . . . .	86	
	Aluminium Deck Support System HKP . . . . .	70 - 71	DrainTec Clip . . . . .	85	
	Aluminium eaves . . . . .	83	Drill Tool 50X . . . . .	97	
	Aluminium function strip . . . . .	74	Drill-Stop . . . . .	123	
	Aluminium profile drilling screw . . . . .	63	Drill-Stop for Profile drilling screw . . . . .	123	
	Aluminium support-profile connector . . . . .	72	Drywall screws . . . . .	332	
	Anchor nails . . . . .	347			
	Anchor rod . . . . .	397 - 398	<b>E</b>	Eaves ventilation element . . . . .	424
	Angle bracket . . . . .	338		EckTec . . . . .	346
	Angle-bracket screw . . . . .	324, 338		ECO PT. . . . .	322 - 323
	Angled screwing attachment . . . . .	119, 352		ECO system clip . . . . .	91
	Assembly pliers . . . . .	333		ECO system connector . . . . .	66
	Assembly screw . . . . .	330		EcoTec . . . . .	318 - 319
	Assembly wedges . . . . .	383 - 384		Edge joints . . . . .	76 - 87
	Atlas wood connector . . . . .	166 - 169		EiSYS-2 . . . . .	431 - 432
	Auger bit/-set . . . . .	382		EiSYS-Aluminium . . . . .	426 - 427
				EiSYS-Timber . . . . .	428 - 430
<b>B</b>	BASE-Line adjustable pedestals . . . . .	42 - 43		EMD Multi plug . . . . .	395
	Basic Shop . . . . .	99, 111		End profiles for aluminium substructure . . . . .	80
	Beam grip with ratchet . . . . .	353		End profiles for single point support . . . . .	78
	BiGHTY drilling screw . . . . .	72, 414 - 416		EPDM façade tape . . . . .	266
	Bird control spikes . . . . .	423		EST dowel bar . . . . .	258
	Bird screen/Ventilation profile . . . . .	425		Evenco aluminium system profile . . . . .	66
	Bit boxes . . . . .	119, 352		Evenco corner connector . . . . .	66
	Bit dispenser box . . . . .	118		EVO aluminium system profile connector . . . . .	58
	Bit holder . . . . .	118		EVO corner connector . . . . .	58
	Blow pump . . . . .	398		EVO joint . . . . .	61
	Blue chalk . . . . .	380		EVO Light aluminium system profile . . . . .	64
	Blue-Power façade mounting system . . . . .	434 - 436		EVO Light system clip . . . . .	90
	Bolt anchor . . . . .	393 - 394		EVO Light system connector . . . . .	64
	Bracing strap . . . . .	339		EVO position anchor . . . . .	60
	Bracing strap tensioner . . . . .	353		EVO Slim aluminium system profile . . . . .	62
	BRUTUS threaded rod . . . . .	202 - 203		EVO Slim aluminium system profile connector . . . . .	62
	Bugle-head screw . . . . .	418		EVO wall-connection bracket . . . . .	60
				EVO/EVO Black Edition aluminium system profile . . . . .	56
<b>C</b>	Carpenter's hammer . . . . .	365		Express nail . . . . .	406
	Cartridge gun . . . . .	398		Extension rings . . . . .	47
	Cavity dowel . . . . .	333		External corner deck edging set . . . . .	79
	Ceiling anchor . . . . .	408	<b>F</b>		
	Chalk line set . . . . .	380		Façade fixing screw ZK . . . . .	129, 265
	Cleaning brush . . . . .	398		Façadeclip . . . . .	125, 261
	Click adapter . . . . .	47		Façadeclip for Rhombus profiles . . . . .	126 - 128, 262 - 264
	CLT system angle . . . . .	242 - 243		Fall arrest system . . . . .	356
	Coloured façade screw . . . . .	421		Fascia profile HKP . . . . .	71
	Combi Laser . . . . .	378		Fence post connection screw . . . . .	134, 342
	Compensation disk . . . . .	50		Fibre cement screw . . . . .	419
	Concrete frame screw . . . . .	409 - 410		Flex-Stone-Clip . . . . .	63
	Concrete screws . . . . .	388 - 392		FloorFix . . . . .	326 - 327
	Cork . . . . .	35, 74 - 75		Folding cutter/-set . . . . .	374
	Cork pad spacer . . . . .	35		Frame fixing . . . . .	402 - 403
	Cork pad with adhesive tape . . . . .	75		FuboFix . . . . .	326
	Corner brackets S, M and L <b>NEW</b> . . . . .	255 - 256	<b>G</b>		
	Corner connectors . . . . .	137, 345		Glazing blocks . . . . .	408
	Corner connector EVO Light . . . . .	64		Glider screw . . . . .	93
	Corner connector set for deck edging . . . . .	79	<b>H</b>		
	Cover profile . . . . .	84		H post anchor . . . . .	134, 342
	CoverFix façade guide rail <b>NEW</b> . . . . .	437		Hammer tacker . . . . .	381
	Cross bracing EVO <b>NEW</b> . . . . .	57		Hammer-in ground sockets . . . . .	135, 343
	Cross bracing Evenco <b>NEW</b> . . . . .	67		Hapatec . . . . .	112 - 113
	Cross-line Laser . . . . .	378		HB/HH flat shearing angle . . . . .	244 - 246
	Cutter . . . . .	374		Hex nuts . . . . .	347
<b>D</b>	Deck edging end profiles . . . . .	78 - 81		Hidden fastening . . . . .	56, 74, 88 - 101
	Deck fascia board mount . . . . .	84		Highload tension rod . . . . .	249
	Deck gliders . . . . .	92 - 93		Hobotec screw . . . . .	114 - 116, 317
	Deck screw 50X . . . . .	98	<b>I</b>		
	Decking Clip <b>NEW</b> . . . . .	101		IdeeFix . . . . .	191 - 197
				Impact rivets . . . . .	407
				Injection mortar . . . . .	396 - 401
				Inside corner deck edging set . . . . .	79

Insulation knife	376	Roofing screw	417
Insulation knife, double-sided	376	Root control fleece underlay	36
Interwoven fence fitting	338	Round slings <b>NEW</b>	190, 367 - 368
<b>J</b> Japanese saw	375	<b>S</b> Sandwich-panel screw	417
Joist hangers	339	SawTec	291 - 294
Justitec	327	Screw clamps	365
<b>K</b> Klimax	438, 439	Screw Stop	123
KonstruX fully threaded screws	204 - 227	Screw-on sockets	136, 344
<b>L</b> L adapter	47	ScrewFiX screw-in aid	354
Laser Rangefinder 50M	377	Screws in magazine	305 - 309
Lashing strap <b>NEW</b>	369 - 372	Selecting screw steels for their corrosion resistance	18
LBS construction screw	320 - 321	Shearing	105
Level Mate	51	Shearing angle	236, 238 - 239
Level Max	411	Shearing plate	237, 240 - 241
Lifting Anchor	172 - 180	Silent EPDM decoupling profile	267
Lifting Anchor Mini <b>NEW</b>	172, 181 - 189	Simply tie bar	250
Long-bit 50X	98	Single-use lifting strap	366
<b>M</b> Magnet Bit Set	120, 351	SL PRO adjustable pedestals	48
Magnet TX Long Bit	120, 351	Slab grip with ratchet	353
Magnetic spirit level	380	Slab supports	49
Magnus hook connector	146 - 165	SonoTec Angular Decoupler	237, 277
Mammutec	117	SonoTec, sound insulation cork	268 - 276
Material requirements planning	29 - 33	Spacer screw	326
MaTre band	65	Spacers	122
Maxi pack	335	Stainless steel Long Bit	120, 351
Mounting connector	260	StarterClip	95
Mounting disc	410	Static mixer	397
Multitool	375	Step drill 50X	98
<b>N</b> Nivello 2.0	48	Stone adapter	47
<b>O</b> OSB Fix	316	Stone slab spacers	50
Overview of timber types	20 - 26	Stone terraces	30, 38 - 39
<b>P</b> Paneltwistec	295 - 304, 313	Stone-Edge-Clip	63
Paneltwistec 1000	328 - 329	Stone-slab lifter	50
Paneltwistec A4/A2	314 - 316	Stone-System	38 - 39, 63
Paneltwistec AG	281 - 290, 313	Substructure	16 - 17, 34 - 35, 70 - 71
Paneltwistec slate screw	325	Suction lifter	355
Panhead TX	329 - 330	Support-profile HKP	71
PediX Duo	133, 201	Support-transom connector	170 - 171
PediX Easy	132, 200	<b>T</b> T-Profile	257
PediX post feet	130 - 131, 198 - 199	T-Stick	96
Perforated mounting strips <b>NEW</b>	340 - 341	Tape measure	379
Plugs	402 - 403, 404 - 405, 407	Tenax spacer	122
Pocket tape measure	379	Tension clamp	122
Porous concrete screw 1000	395	Tension rod 340/440	247 - 248
Post holder	136 - 137, 344 - 345	Tension strap	251 - 254
Post support 135 + 65	138, 346	Terrassotec	107 - 111
Pressure sleeve	398	Terrassotec Tribolular	107 - 108
Profi-Line adjustable pedestals	46 - 47	Thermofix screw	93
Profile connector set for deck edging	79	Threaded rod	347
Profile drilling screw	106	Timber decks	17, 19, 29
ProPack <b>NEW</b>	280 - 287	Timber frame screw	411
Protective helmet	364	Topduo Roofing screw	310 - 312
Protectus timber-protection tape	36	Transport anchor system	373
Pyramid post cap	135, 343	Tri-Deck-Tec	110
<b>Q</b> Quattro-Lager	49	Twin system clip	89
Quick-change bit holder	121, 350	TX Long Bit	121, 350
<b>R</b> Ratchet screwdriver 12-in-1	120, 351	TX-Bit	121, 350
Ratchets	381	<b>U</b> U brackets	137, 345
Retail shelving unit	140 - 141, 334 - 335	U post holder	136 - 137, 344 - 345
Ridge batten holder 50	422	Underground	14 - 15
Ridge end disc	424	Uni-Tape	425
Ridge screw	422	Universal wood construction screw	331
Ripsaw	376	<b>V</b> V-Clip	100
Robusto deck pedestal	52 - 53	Ventilation profile	425
Rock concrete screws	388 - 392	Visible fastening	56, 74, 103 - 106
Rolfi roll	37	<b>W</b> Wall and fireplace connection	425
Rolfi, spacers	36	Wall connecting bar	420
Roller ridge	424	Wall support	366
Roof accessories	422 - 425	Washer	316, 347
Roof venting hose	423	Washed screw	420
Roof-protection cork	35	Wing-tipped drilling screw	325
		Wing-tipped profile drilling screw	106
		Wood-concrete composite system	228 - 230
		Work gloves <b>NEW</b>	357 - 363







## Conditions of sale and delivery

All sales to buyers, customers and contract partners, hereinafter referred to as customers, are made exclusively subject to the following terms and conditions unless other agreements are made in writing in the individual case:

### 1. Scope, general provisions

Our terms and conditions shall apply exclusively! We will not accept contradictory terms and conditions of our customers that deviate from our conditions unless we have given our express written consent to their validity. Our terms and conditions shall apply even if we execute orders without reservation despite being aware of contradictory conditions or conditions that deviate from our terms and conditions. Our terms and conditions shall also apply to all future transactions with our customers. Customers can access the latest version of these Standard Terms and Conditions at [www.eurotec.team](http://www.eurotec.team) at any time.

### 2. Offers, written form

Our offers are non-binding and subject to alteration without notice until we issue our final order confirmation. Contracts and agreements, as well as transactions brokered by our representatives, shall become binding only when we issue our written order confirmation. Verbal agreements, even within the framework of contract execution, are not valid unless confirmed by us in writing.

### 3. Prices, packaging, offsetting

Unless otherwise indicated by the order confirmation, our prices are ex-works and exclusive of packaging. This is billed separately. The minimum order value is €50.00. For smaller quantities, we charge a flat processing fee of €30.00.

- Our prices are exclusive of statutory value added tax. This is stated and charged separately in the invoice at the statutory rate applicable on the date of billing.
- Our customer may only claim a right of offsetting insofar as counterclaims are established to be legally binding or are undisputed or accepted. A right of retention may only be exercised with respect to counterclaims resulting from the same contractual relationship.

### 4. Delivery, delivery period and force majeure

Unless otherwise agreed in writing, the place of performance shall be our company premises. The goods are shipped at the customer's risk and expense by third parties acting on our behalf. From the time at which the goods are made ready for delivery and the customer has been informed of their readiness for shipping, the customer shall bear the risk of accidental loss or deterioration of the item. This shall apply even if shipping is delayed as a result of circumstances for which we are not responsible. Punctual handing over of the goods to a shipping company requires that the order be placed on time by our customer. If the goods are handed over to the appointed shipping company punctually, we will not be liable for delayed delivery to the customer. This shall apply even if a delivery deadline was agreed with the customer, especially in the case of delivery to a construction site. The customer may be exempted from rush charges incurred in relation to this if there is a legal basis for deducting this surcharge from the forwarder's bill.

Statements relating to delivery periods are always to be seen only as approximate and non-binding. They shall begin on the date of our order confirmation but not before all of the order details are clarified in full. They refer to the time of consignment ex-works and shall be considered met when the goods are reported to be ready for dispatch. Without prejudice to our rights arising due to the customer's default, they shall be extended by the period for which the customer is in arrears to us with respect to their obligations arising from this or other orders.

Even if they arise at our suppliers, the following grounds are among those that shall release us from the obligation to adhere to the delivery period and shall entitle us to extend the delivery periods, to make partial deliveries or to wholly or partially withdraw from the part of the contract that is not yet fulfilled without becoming liable to pay damages as a result, unless we are guilty of intent or gross negligence: interruptions of operations and difficulties in delivery of any kind, e.g. shortages of machinery, goods, materials or fuels, or incidents of force majeure, e.g. export and import embargos, fires, strikes, lock-outs or new official measures that adversely affect production costs and shipping.

### 5. Shipping

Goods are shipped at the expense and risk of the customer even if prepaid delivery was agreed. Additional costs for express shipping shall always be borne by the customer. Freight costs paid by us are to be seen only as an advancement of freight charges on behalf of the customer. Additional freight costs for urgent and express parcels shall be borne by the customer, even if we have borne the transport costs on individual occasions. Goods reported as ready for shipping must be accepted immediately and will be charged as ex-works. If the goods are to be shipped abroad or passed directly to third parties, they must be examined and accepted in our factory; otherwise, the goods shall be deemed to have been delivered in accordance with the contract to the exclusion of any complaints. The risk, including that of confiscation, shall be transferred to the customer when the goods are handed over to the forwarder or freight carrier and, at the latest, when they leave our facility. Return shipments always require prior consultation with our internal sales department. Goods that are free of defects are only taken back with our express consent. A credit note is then issued for the value of the goods with deduction of a 25% return fee per item or against a minimum fee of €50 for returning the goods to storage. Strictly no debit notes are accepted.

### 6. Design and property rights

The customer shall bear sole responsibility and be liable for ensuring that the goods it orders do not violate thirdparty property rights. No verification is performed on our part in this respect. The customer shall indemnify us against injunctions or claims for damages by third parties. If an injunction is requested against us, the customer shall meet the legal costs and shall compensate us for the damages we have incurred.

### 7. Acceptance, quantity tolerances and call-offs

For contracts with ongoing deliveries, the goods are to be accepted in monthly quantities that are as consistent as possible over the course of the contractual period. If a call-off is not made on time, we shall be entitled, after the expiry of a grace period that we have granted, to divide the order at our own discretion, withdraw from the part of the contract that has not yet been executed, or make a claim for damages due to non-performance. In the case of call-off orders, the call-offs must always be made within 12 calendar months. Over- or under-shipment by up to 10% of the order shall be permissible.

### 8.1 Payment terms for invoices, right of retention

Invoices shall be payable with a 2% discount within 10 days of the invoice date or net within 30 days, regardless of when the goods are received and without prejudice to the right to make a complaint for defects. Payment by means of acceptance or customer's bill of exchange shall require special written agreement in advance. Discount charges will be charged in the case of payment by means of acceptance, which must have a term no longer than 3 months and be issued within 1 week of the invoice date. Credit notes for bills of exchange or cheques shall apply subject to receipt and regardless of the purchase price's earlier due date in the event of default by the customer. They shall be issued with the value at the date on which the equivalent amount will be available to us; the discount charges will be charged at the respective bank rate. In the event that the payment term is exceeded, interest and commissions may be charged without prejudice to other rights at the respective bank rate for overdrafts but at a rate at least 5% above the respective discount rate of the Deutsche Bundesbank [German Federal Bank]. If the payment terms are not adhered to or we become aware of circumstances that, in our view, are sufficient to reduce the customer's credit worthiness, all of our claims shall become payable immediately regardless of the term of any bills of exchange that have been accepted or credited.

We shall then also be entitled to perform outstanding deliveries only in exchange for advance payment, to withdraw from the contract after a reasonable grace period, and to demand compensation for default. We may also prohibit the resale or processing of the delivered goods and demand their return or the transfer of indirect possession of the delivered goods at the customer's expense. The customer hereby already authorises us to enter its premises and confiscate the delivered goods in the above cases. We shall be entitled to the usual securities for our claims according to their nature and extent, even if they are subject to conditions or of limited duration. Offsetting or withholding

payments as a result of any counterclaims or notifications of defects shall be prohibited, except where claims are undisputed or established to be legally binding.

### 8.2 Terms of payment for web-shop customers

Payment shall be made exclusively in advance. Once the order process in our online shop is complete, you will receive an email with the bank details for our business account. The invoiced amount must be transferred to our account within 7 days. We cannot carry out your order until the payment arrives.

### 9. Retention of title

Until all liabilities arising from the business relationship are paid in full and, in particular, until all bills of exchange and cheques, including finance bills, given as payment are cashed, the goods delivered by us shall remain our property and may be taken back by us at the customer's expense in the event of default in payment. Until this point, the customer shall not be entitled to pledge or assign the goods to third parties as a security; it may sell them on or process them only within the framework of its ongoing business transactions. The customer shall be obliged to inform us immediately of any seizure by third parties of the goods delivered subject to retention of title.

In the event of further processing, the customer shall not acquire ownership of the goods delivered by us as set out in section 950 of the German Civil Code (BGB), as any processing is carried out by the customer on our behalf. Without prejudice to the rights of third-party suppliers, the newly created thing shall serve as security for us up to the amount of our total claims arising from the business relationship. It shall be kept safe for us by the customer and shall be regarded as goods for the purpose of these terms and conditions. If the item is intermixed or otherwise combined with other objects that do not belong to us, we shall acquire at least co-ownership of the new thing in proportion to the value of the contract item to that of other objects that have been processed with it. If the customer sells the goods delivered by us, regardless of their condition, it hereby already assigns to us all claims against its customers arising from sales, as well as all ancillary rights, until all of our claims arising from delivery of goods are paid in full. At our request, the customer shall be obliged to notify its downstream customers of the assignment and to hand over the information and documents we require in order to assert our rights against its downstream customers.

If the total value of the securities given to us exceeds our claims arising from delivery by more than 20%, we shall be obliged to retransfer securities to this extent at the customer's request. If the retention of title or assignment is invalid in the territory in which the goods are located, a security corresponding to the retention of title or assignment in this territory shall be deemed to be agreed. If the customer's cooperation is required in this process, it shall take all necessary measures to establish such rights.

### 10. Notification of defects, liability

Our customer shall be entitled to a warranty only if they have properly fulfilled their legal obligations under sections 377 and 378 of the German Commercial Code (HGB) with respect to the duties of examination and notification. If defects are present, we shall be entitled at our choice to either repair the defects or provide a replacement; if we are not prepared or not able to do so, and especially if repair/replacement is delayed beyond reasonable deadlines for reasons that we are responsible for, or if repair/replacement otherwise fails, our customer shall be entitled at its choice to withdraw from the contract or to demand a corresponding reduction in the price.

Unless otherwise stipulated below, further claims of the customer shall be excluded regardless of their legal basis. We shall not be liable for damage that did not occur to the delivered item itself. In particular, we shall not be liable for lost profit or other pecuniary losses of the customer. The above exemption from liability shall not apply if the damage is caused by intent or gross negligence; it shall also not apply if the customer asserts claims for damages for non-performance due to the lack of a warranted characteristic. If we breach an essential contractual duty through negligence, our duty of reimbursement for property damage or personal injury shall be restricted to the level of cover provided by our product liability insurance.

We are prepared to allow the customer to view our policy. The warranty period is 6 months calculated from the date of transfer of risk. This period is a limitation period. The period shall also apply to claims under sections 1 and 4 of the German Product Liability Act (ProdHaftG). Insofar as our liability is excluded or restricted, this shall also apply to the personal liability of our employees, workers, staff, representatives and agents. Goods that are subject to a complaint must not be sent back without obtaining our prior written consent, as otherwise we may refuse to accept them at the sender's expense. Goods that have been partially or wholly processed will not be taken back under any circumstances.

The customer is obliged to make sure that the purchased product is suitable for the intended application using technical descriptions, where available, and based on their specialist knowledge and to familiarise themselves with the application of this product. If they are not familiar with the product's application, our company staff are available to provide advice. All information and advice from our staff is provided carefully and conscientiously.

Under no circumstances does this information and advice replace the indispensable consultancy services of architects and specialist planning companies or the services they provide during construction. Only the authorised professional groups are entitled to provide these services.

### 11. Place of performance and jurisdiction, miscellaneous

Our company's registered office shall be the place of performance for all obligations arising from this contract, including liabilities from cheques and bills of exchange. Provided our customer is a merchant, the place of jurisdiction for all disputes arising from the contractual relationship shall be, at our choice, the Local Court of Hagen. Contracts with our customer shall be governed exclusively by German law to the exclusion of the UN Convention on Contracts for the International Sale of Goods of 11 April 1980. The language of the contract shall be German.

Hagen, 16 February 2018

E.u.r.o.Tec GmbH · Unter dem Hofe 5 · 58099 Hagen  
 Managing directors: Markus Rensburg, Gregor Mamys  
 Court of registration: Local Court of Hagen Registration number: HRB 3817  
 VAT ID No.: DE 812674291  
 Tax number: 321/5770/0639

Tel. +49 2331 62 45-0 · Fax +49 2331 62 45-200 · email [info@eurotec.team](mailto:info@eurotec.team) · [www.eurotec.team](http://www.eurotec.team)

Publisher: E.u.r.o.Tec GmbH - Revised 12/2021

The content is subject to errors and technical changes and additions.

All dimensions are approximate values. The information is subject to model and color deviations, as well as errors.

We accept no liability for printing errors. Reprinting (even in part) is only permitted with E.u.r.o.Tec GmbH's prior approval.

**E.u.r.o.Tec GmbH**  
Unter dem Hofe 5  
D-58099 Hagen · Germany  
Tel. +49 2331 62 45-0  
Fax +49 2331 62 45-200  
E-Mail [info@eurotec.team](mailto:info@eurotec.team)

**Follow us**



[www.eurotec.team/en](http://www.eurotec.team/en)